



Handheld Thermography Camera HIKMICRO SP Series

User Manual



Contact Us

Legal Information

©2023 Hangzhou Microimage Software Co., Ltd. All rights reserved.

About this Manual

The Manual includes instructions for using and managing the Product. Pictures, charts, images and all other information hereinafter are for description and explanation only. The information contained in the Manual is subject to change, without notice, due to firmware updates or other reasons. Please find the latest version of this Manual at the HIKMICRO website (<http://www.hikmicrotech.com>).

Please use this Manual with the guidance and assistance of professionals trained in supporting the Product.

Trademarks

 **HIKMICRO** and other HIKMICRO's trademarks and logos are the properties of HIKMICRO in various jurisdictions.

Other trademarks and logos mentioned are the properties of their respective owners.

 **HDMI**™ The terms HDMI and HDMI High-Definition Multimedia Interface, and

the HDMI Logo are trademarks or registered trademarks of HDMI Licensing Administrator, Inc. in the United States and other countries.

Disclaimer

TO THE MAXIMUM EXTENT PERMITTED BY APPLICABLE LAW, THIS MANUAL AND THE PRODUCT DESCRIBED, WITH ITS HARDWARE, SOFTWARE AND FIRMWARE, ARE PROVIDED "AS IS" AND "WITH ALL FAULTS AND ERRORS". HIKMICRO MAKES NO WARRANTIES, EXPRESS OR IMPLIED, INCLUDING WITHOUT LIMITATION, MERCHANTABILITY, SATISFACTORY QUALITY, OR FITNESS FOR A PARTICULAR PURPOSE. THE USE OF THE PRODUCT BY YOU IS AT YOUR OWN RISK. IN NO EVENT WILL HIKMICRO BE LIABLE TO YOU FOR ANY SPECIAL, CONSEQUENTIAL, INCIDENTAL, OR INDIRECT DAMAGES, INCLUDING, AMONG OTHERS, DAMAGES FOR LOSS OF BUSINESS PROFITS, BUSINESS INTERRUPTION, OR LOSS OF DATA, CORRUPTION OF SYSTEMS, OR LOSS OF DOCUMENTATION, WHETHER BASED ON BREACH OF CONTRACT, TORT (INCLUDING NEGLIGENCE), PRODUCT LIABILITY, OR OTHERWISE, IN CONNECTION WITH THE USE OF THE PRODUCT, EVEN IF HIKMICRO HAS BEEN ADVISED OF THE POSSIBILITY OF SUCH DAMAGES OR LOSS.

YOU ACKNOWLEDGE THAT THE NATURE OF THE INTERNET PROVIDES FOR INHERENT SECURITY RISKS, AND HIKMICRO SHALL NOT TAKE ANY RESPONSIBILITIES FOR ABNORMAL OPERATION, PRIVACY LEAKAGE OR OTHER DAMAGES RESULTING FROM

Handheld Thermography Camera User Manual

CYBER-ATTACK, HACKER ATTACK, VIRUS INFECTION, OR OTHER INTERNET SECURITY RISKS; HOWEVER, HIKMICRO WILL PROVIDE TIMELY TECHNICAL SUPPORT IF REQUIRED. YOU AGREE TO USE THIS PRODUCT IN COMPLIANCE WITH ALL APPLICABLE LAWS, AND YOU ARE SOLELY RESPONSIBLE FOR ENSURING THAT YOUR USE CONFORMS TO THE APPLICABLE LAW. ESPECIALLY, YOU ARE RESPONSIBLE, FOR USING THIS PRODUCT IN A MANNER THAT DOES NOT INFRINGE ON THE RIGHTS OF THIRD PARTIES, INCLUDING WITHOUT LIMITATION, RIGHTS OF PUBLICITY, INTELLECTUAL PROPERTY RIGHTS, OR DATA PROTECTION AND OTHER PRIVACY RIGHTS. YOU SHALL NOT USE THIS PRODUCT FOR ANY PROHIBITED END-USES, INCLUDING THE DEVELOPMENT OR PRODUCTION OF WEAPONS OF MASS DESTRUCTION, THE DEVELOPMENT OR PRODUCTION OF CHEMICAL OR BIOLOGICAL WEAPONS, ANY ACTIVITIES IN THE CONTEXT RELATED TO ANY NUCLEAR EXPLOSIVE OR UNSAFE NUCLEAR FUEL-CYCLE, OR IN SUPPORT OF HUMAN RIGHTS ABUSES.

IN THE EVENT OF ANY CONFLICTS BETWEEN THIS MANUAL AND THE APPLICABLE LAW, THE LATER PREVAILS.

Regulatory Information

These clauses apply only to the products bearing the corresponding mark or information.

FCC Information

Note: This equipment has been tested and found to comply with the limits for a Class A digital device, pursuant to part 15 of the FCC Rules. These limits are designed to provide reasonable protection against harmful interference when the equipment is operated in a commercial environment. This equipment generates, uses, and can radiate radio frequency energy and, if not installed and used in accordance with the instruction manual, may cause harmful interference to radio communications. Operation of this equipment in a residential area is likely to cause harmful interference in which case the user will be required to correct the interference at his own expense.

Please take attention that changes or modification not expressly approved by the party responsible for compliance could void the user's authority to operate the equipment.

This device complies with part 15 of the FCC Rules. Operation is subject to the following two conditions:

- (1) this device may not cause harmful interference, and
- (2) this device must accept any interference received, including interference that may cause undesired operation.

Note: Due to the device size limit, the above statement may not be disclaimed on the device.

EU Conformity Statement



This product and - if applicable - the supplied accessories too are marked with "CE" and comply therefore with the applicable harmonized European standards listed under the Directive 2014/30/EU (EMCD), Directive 2014/35/EU (LVD), Directive 2011/65/EU (RoHS).

Hereby, Hangzhou Microimage Software Co., Ltd. declares that this device (refer to the label) is in compliance with Directive 2014/53/EU.

The full text of the EU declaration of conformity is available at the following internet address:

<https://www.hikmicrotech.com/en/support/download-center/declaration-of-conformity/>.



This product and - if applicable - the supplied accessories too are marked with "UKCA" and comply therefore with the following directives: Radio Equipment Regulations 2017, Electromagnetic Compatibility Regulations 2016, Electrical Equipment (Safety) Regulations 2016, the Restriction of the Use of Certain Hazardous Substances in Electrical and Electronic Equipment Regulations 2012.

Restrictions in the 5 GHz band:

According to Article 10 (10) of Directive 2014/53/EU, when operating in the 5150 to 5350 MHz frequency range, this device is restricted to indoor use in: Austria (AT), Belgium (BE), Bulgaria (BG), Croatia (HR), Cyprus (CY), the Czech Republic (CZ), Denmark (DK), Estonia (EE), Finland (FI), France (FR), Germany (DE), Greece (EL), Hungary (HU), Iceland (IS), Ireland (IE), Italy (IT), Latvia (LV), Liechtenstein (LI), Lithuania (LT), Luxembourg (LU), Malta (MT), Netherlands (NL), Northern Ireland (UK(NI)), Norway (NO), Poland (PL), Portugal (PT), Romania (RO), Slovakia (SK), Slovenia (SI), Spain (ES), Sweden (SE), Switzerland (CH), and Turkey (TR).

In accordance with the Radio Equipment Regulations 2017 in the UK, the device working in the 5150 to 5350 MHz frequency range is restricted to indoor use in the United Kingdom.

Frequency Bands and Power (for CE/UKCA)

The frequency bands and modes and transmitting power (radiated and/or conducted) nominal limits applicable to the following radio equipment are as follows:

Wi-Fi: 2.4 GHz (2.4 GHz to 2.4835 GHz): 20 dBm; 5 GHz (5.15 GHz to 5.25 GHz): 23 dBm; 5 GHz (5.25 GHz to 5.35 GHz): 23 dBm; 5 GHz (5.47 GHz to 5.725GHz): 23 dBm; 5 GHz (5.725 GHz to 5.85 GHz): 14 dBm

Bluetooth: 2.4 GHz (2.4 GHz to 2.4835 GHz): 20 dBm

Use the power adapter provided by a qualified manufacturer. Refer to the product specification for detailed power requirements.

Use the battery provided by a qualified manufacturer. Refer to the product specification for detailed battery requirements.



Directive 2012/19/EU (WEEE Directive): Products marked with this symbol cannot be disposed of as unsorted municipal waste in the European Union. For proper recycling, return this product to your local supplier upon the purchase of equivalent new equipment, or dispose of it at designated collection points. For more information see: www.recyclethis.info

According to the Waste Electrical and Electronic Equipment Regulations 2013: Products marked with this symbol cannot be disposed of as unsorted municipal waste in the United Kingdom. For proper recycling, return this product to your local supplier upon the purchase of equivalent new equipment, or dispose of it at designated collection points. For more information see: www.recyclethis.info.



Directive 2006/66/EC and its amendment 2013/56/EU (Battery Directive): This product contains a battery that cannot be disposed of as unsorted municipal waste in the European Union. See the product documentation for specific battery information. The battery is marked with this symbol, which may include lettering to indicate cadmium (Cd), lead (Pb), or mercury (Hg). For proper recycling, return the battery to your supplier or to a designated collection point. For more information see: www.recyclethis.info.

According to the Batteries and Accumulators (Placing on the Market) Regulations 2008 and the Waste Batteries and Accumulators Regulations 2009: This product contains a battery that cannot be disposed of as unsorted municipal waste in the United Kingdom. See the product documentation for specific battery information. The battery is marked with this symbol, which may include lettering to indicate cadmium (Cd), lead (Pb), or mercury (Hg). For proper recycling, return the battery to your supplier or to a designated collection point. For more information see: www.recyclethis.info.

Warning: This is a class A product. In a domestic environment this product may cause radio interference in which case the user may be required to take adequate measures.

Industry Canada ICES-003 Compliance

This device meets the CAN ICES-003 (A)/NMB-003(A) standards requirements. This device complies with Industry Canada licence-exempt RSS standard(s). Operation is subject to the following two conditions:

- (1) this device may not cause interference, and
- (2) this device must accept any interference, including interference that may cause undesired operation of the device.

This equipment complies with IC RSS-102 radiation exposure limits set forth for an

uncontrolled environment. This equipment should be installed and operated with minimum distance 20 cm between the radiator & your body.

- (i) The device for operation in the band 5150-5250 MHz is only for indoor use to reduce the potential for harmful interference to co-channel mobile satellite systems;
- (ii) The maximum antenna gain permitted for devices in the bands 5250-5350 MHz and 5470-5725 MHz shall comply with the e.i.r.p. limit; and
- (iii) The maximum antenna gain permitted for devices in the band 5725-5825 MHz shall comply with the e.i.r.p. limits specified for point-to-point and non point-to-point operation as appropriate.

Conformité Industrie Canada ICES-003

Le présent appareil est conforme aux CNR d'Industrie Canada applicables aux appareils radioexempts de licence. L'exploitation est autorisée aux deux conditions suivantes :

- (1) l'appareil ne doit pas produire de brouillage, et
- (2) l'utilisateur de l'appareil doit accepter tout brouillage radioélectrique subi, même si le brouillage est susceptible d'en compromettre le fonctionnement.

ce matériel est conforme aux limites de dose d'exposition aux rayonnements, CNR-102 énoncée dans un autre environnement. cette equipment devrait être installé et exploité avec distance minimale de 20 entre le radiateur et votre corps.

- (i) Les dispositifs fonctionnant dans la bande 5150-5250 MHz sont réservés uniquement pour une utilisation à l'intérieur afin de réduire les risques de brouillage préjudiciable aux systèmes de satellites mobiles utilisant les mêmes canaux.
- (ii) Le gain d'antenne maximal autorisé pour les appareils dans les bandes 5250-5350 MHz et 5470-5725 MHz doivent respecter le pire limiter; et
- (iii) Le gain d'antenne maximal autorisé pour les appareils dans la bande 5725-5825 MHz doivent respecter le pire limites spécifiées pour le point-à-point et l'exploitation non point à point, le cas échéant.

NCC

取得審驗證明之低功率射頻器材，非經核准，公司、商號或使用者均不得擅自變更頻率、加大功率或變更原設計之特性及功能。

低功率射頻器材之使用不得影響飛航安全及干擾合法通信；經發現有干擾現象時，應立即停用，並改善至無干擾時方得繼續使用。

前述合法通信，指依電信管理法規定作業之無線電通信。

低功率射頻器材須忍受合法通信或工業、科學及醫療用電波輻射性電機設備之干擾。



應避免影響附近雷達系統之操作。

KC

A급 기기: 이 기기는 업무용(A급) 전자파적합기기로서 판매자 또는 사용자는 이 점을 주의하시기바라며, 가정 외의 지역에서 사용하는 것을 목적으로 합니다.

Symbol Conventions

The symbols that may be found in this document are defined as follows.

Symbol	Description
 Danger	Indicates a hazardous situation which, if not avoided, will or could result in death or serious injury.
 Caution	Indicates a potentially hazardous situation which, if not avoided, could result in equipment damage, data loss, performance degradation, or unexpected results.
 Note	Provides additional information to emphasize or supplement important points of the main text.

Safety Instruction

These instructions are intended to ensure that user can use the product correctly to avoid danger or property loss. Please read all the safety information carefully before using.

Laws and Regulations

- Use of the product must be in strict compliance with the local electrical safety regulations.

Transportation

- Keep the device in original or similar packaging while transporting it.
- Keep all wrappers after unpacking them for future use. In case of any failure occurred, you need to return the device to the factory with the original wrapper. Transportation without the original wrapper may result in damage on the device and the company shall not take any responsibilities.
- DO NOT drop the product or subject it to physical shock. Keep the device away from magnetic interference.

Power Supply

- Please purchase the charger by yourself. Input voltage should meet the Limited Power Source (7.2 VDC, 890 mA) according to the IEC61010-1 standard. Please refer to technical specifications for detailed information.
- Make sure the plug is properly connected to the power socket.
- DO NOT connect multiple devices to one power adapter, to avoid over-heating or fire hazards caused by overload.

Battery

- CAUTION: Risk of explosion if the battery is replaced by an incorrect type. Replace with the same or equivalent type only. Dispose of used batteries in conformance with the instructions provided by the battery manufacturer.
- Improper replacement of the battery with an incorrect type may defeat a safeguard (for example, in the case of some lithium battery types).
- Do not dispose of the battery into fire or a hot oven, or mechanically crush or cut the battery, which may result in an explosion.
- Do not leave the battery in an extremely high temperature surrounding environment, which may result in an explosion or the leakage of flammable liquid or gas.
- Do not subject the battery to extremely low air pressure, which may result in an explosion or the leakage of flammable liquid or gas.
- The built-in battery cannot be dismantled. Please contact the manufacture for repair if necessary.

Handheld Thermography Camera User Manual

- For long-term storage of the battery, make sure it is fully charged every half year to ensure the battery quality. Otherwise, damage may occur.
- DO NOT charge other battery types with the supplied charger. Confirm there is no flammable material within 2 m of the charger during charging.
- DO NOT place the battery near heating or fire source. Avoid direct sunlight.
- DO NOT swallow the battery to avoid chemical burns.
- DO NOT place the battery in the reach of children.
- When the device is powered off and the RTC battery is full, the time settings can be kept for 3 months.
- The lithium battery voltage is 7.2 V, and the battery capacity is 4800 mAh.
- The battery is certified by UL2054.

Maintenance

- If the product does not work properly, please contact your dealer or the nearest service center. We shall not assume any responsibility for problems caused by unauthorized repair or maintenance.
- A few device components (e.g., electrolytic capacitor) require regular replacement. The average lifespan varies, so periodic checking is recommended. Contact your dealer for details.
- Wipe the device gently with a clean cloth and a small quantity of ethanol, if necessary.
- If the equipment is used in a manner not specified by the manufacturer, the protection provided by the device may be impaired.
- We recommend you send the device back for calibration once a year, and please contact the local dealer for the information on maintenance points.
- Please notice that the current limit of USB 3.0 PowerShare port may vary with the PC brand, which is likely to result in incompatibility issue. Therefore it's advised to use regular USB 3.0 or USB 2.0 port if the USB device fails to be recognized by PC via USB 3.0 PowerShare port.
- Your camera will periodically perform a self-calibration to optimize image quality and measurement accuracy. In this process the image will pause briefly and you'll hear a "click" as a shutter moves in front of the detector. The self-calibration will be more frequent during start up or in very cold or hot environments. This is a normal part of operation to ensure optimum performance for your camera.

Using Environment

- Make sure the running environment meets the requirement of the device. The operating temperature shall be -20°C to 50°C (-4°F to 122°F), and the operating humidity shall be 95% or less.
- This device can only be safely used in the region below 2000 meters above the sea level.
- Place the device in a dry and well-ventilated environment.

- DO NOT expose the device to high electromagnetic radiation or dusty environments.
- DO NOT aim the lens at the sun or any other bright light.
- When any laser equipment is in use, make sure that the device lens is not exposed to the laser beam, or it may burn out.
- The device is suitable for indoor and outdoor uses, but do not expose it in wet conditions.
- The level of protection is IP 54.
- The pollution degree is 2.

Technical Support

The <https://www.hikmicrotech.com/en/contact-us.html> portal will help you as a HIKMICRO customer to get the most out of your HIKMICRO products. The portal gives you access to our support team, software and documentation, service contacts, etc.

Emergency

- If smoke, odor, or noise arises from the device, immediately turn off the power, unplug the power cable, and contact the service center.

Laser Light Supplement Warning



Warning: The laser radiation emitted from the device can cause eye injuries, burning of skin or inflammable substances. Prevent eyes from direct laser. Before enabling the Light Supplement function, make sure no human or inflammable substances are in front of the laser lens. The wave length is 650 nm, and the power is less than 1 Mw. The laser meets the IEC60825-1:2014 standard.

Laser maintenance: It is not necessary to maintain the laser regularly. If the laser does not work, the laser assembly needs to be replaced in the factory under warranty. Keep the device power off when replacing laser assembly. Caution-Use of controls or adjustments or performance of procedures other than those specified herein may result in hazardous radiation exposure.

Manufacture Address

Room 313, Unit B, Building 2, 399 Danfeng Road, Xixing Subdistrict, Binjiang District, Hangzhou, Zhejiang 310052, China
Hangzhou Microimage Software Co., Ltd.

COMPLIANCE NOTICE: The thermal series products might be subject to export controls in various countries or regions, including without limitation, the United States, European Union, United Kingdom and/or other member countries of the Wassenaar Arrangement. Please consult your professional legal or compliance expert or local government

Handheld Thermography Camera User Manual

authorities for any necessary export license requirements if you intend to transfer, export, re-export the thermal series products between different countries.

Contents

Chapter 1 Overview	1
1.1 Device Description	1
1.2 Main Function	1
1.3 Appearance	3
Chapter 2 Preparation	9
2.1 Cable Connection	9
2.2 Charge Battery	9
2.2.1 Remove Battery	9
2.2.2 Charge Battery via Charging Base	11
2.3 Change Interchangeable Lens	11
2.4 Mount Hand Strap	14
2.5 Mount Neck Strap	15
2.6 Tilt Lens and Screen	16
2.7 Power On/Off	16
2.8 Sleep and Wake	16
2.9 Operation Method	17
2.10 Menu Description	18
2.10.1 Live View Interface	18
2.10.2 Main Menu	20
2.10.3 Swipe-down Menu	20
Chapter 3 Display Settings	22
3.1 Focus	22
3.1.1 Focus Lens	22
3.1.2 Laser Assisted Focus	23
3.1.3 Auto Focus	23
3.1.4 Continuous Autofocus	24
3.1.5 High Temperature Priority	24

3.2 Set Screen Brightness.....	25
3.3 Set Display Mode.....	25
3.4 Set Palettes.....	26
3.4.1 Set Alarm Mode Palettes.....	27
3.4.2 Set Focus Mode Palettes.....	28
3.5 Adjust Level & Span.....	28
3.5.1 Color Distribution.....	29
3.6 Adjust Digital Zoom.....	30
3.7 Display OSD Info.....	30
Chapter 4 Temperature Measurement.....	32
4.1 Set Measurement Parameters.....	32
4.2 Set Image Measurement.....	33
4.3 Set Measurement Tool.....	34
4.3.1 Measure by Custom Spot.....	35
4.3.2 Measure by Line.....	36
4.3.3 Measure by Rectangle.....	37
4.3.4 Measure by Circle.....	38
4.4 Measure ΔT and ΔT Alarm.....	39
4.5 Temperature Alarm.....	40
4.5.1 Set Alarms for Exceptional Temperatures.....	40
4.6 Calculate Area Size.....	41
4.7 Clear All Measurements.....	42
Chapter 5 Route Inspection.....	43
5.1 Create Inspection Route and Send Task to Device.....	43
5.2 Perform Route Inspection.....	44
5.3 Upload Inspection Result and View Report.....	46
Chapter 6 Picture and Video.....	49
6.1 Capture Picture.....	49
6.2 Record Video.....	52

6.3 View and Manage Local Files	53
6.3.1 Manage Albums	54
6.3.2 Manage Files	55
6.3.3 Edit Images	56
6.4 Export Files	57
Chapter 7 Distance Detection	59
Chapter 8 Geographic Location Display	60
Chapter 9 Direction Display	61
9.1 Calibrate Compass	61
9.2 Magnetic Declination Correction	62
Chapter 10 Device Connections	63
10.1 Connect Bluetooth	63
10.2 Cast Device Screen to PC	63
10.3 Connect Device to Wi-Fi	64
10.4 Set Device Hotspot	64
Chapter 11 Thermal View Mobile Client Connection	66
11.1 Connect via Wi-Fi	66
11.2 Connect via Hotspot	66
Chapter 12 System Settings	67
12.1 Set LED Light	67
12.2 Set Unit	67
12.3 HDMI Image Output	67
12.4 Set Time and Date	67
Chapter 13 Maintenance	68
13.1 View Device Information	68
13.2 Upgrade Device	68
13.3 Restore Device	68
13.4 Initialize Memory Card	69
13.5 About Calibration	69

Handheld Thermography Camera User Manual

Chapter 14 Appendix.....	70
14.1 Common Material Emissivity Reference.....	70
14.2 FAQ.....	70

Chapter 1 Overview

1.1 Device Description

The handheld thermography camera is a device with both optical images and thermal images. It can do thermography, distance measurement, video recording, snapshot capturing, alarm, and it can connect to Wi-Fi, hotspot and Bluetooth. The built-in high-sensitivity IR detector and high-performance sensor detects the variation of temperature and measure the real-time temperature. Refer to the production specification on HIKMICRO website for detailed information. The built-in laser module detects the target distance.

The device is easy to use, and adopts ergonomic design. It is widely applied to substations, electricity prevention detection of companies, and reconnaissance survey of construction field.

1.2 Main Function

Temperature Measurement

Device detects the real-time temperature, and display it on the screen.

Route Inspection

Device can check the temperature of the check points in a predefined inspection route, and upload the results to center client for analysis.

Distance Measurement

Device can detect the target distance with the laser light.

Fusion

Device can display fusion of thermal view and optical view.

Palette and Alarm

Device supports multiple palettes, and you can set the palette mode according to the alarm function.

Geographical Location and Direction Display

For some models that are equipped satellite positioning module and compass, geographical location and direction display are supported.

Note

The function is supported by certain models of this series.

HDMI Output

For some models that have a micro HDMI output interface, you can connect the device to a display unit to view live image.

Client Software Connection

- Mobile Phone: Use HIKMICRO Viewer to see live image, capture, and recording, etc. on your phone.



HIKMICRO Viewer Android



HIKMICRO Viewer iOS

- PC: Use HIKMICRO Analyzer (<https://www.hikmicrotech.com/en/industrial-products/hikmicro-analyzer-software.html>) to see live image, capture, recording, and receive alarm message, etc. on your PC. Use HIKMICRO Inspector to create inspection routes, send route inspection task to devices, collect inspection results and generate analysis reports.

Bluetooth

Device can be connected to headset via Bluetooth, and you can hear the voice in the recording or capture.

1.3 Appearance

I

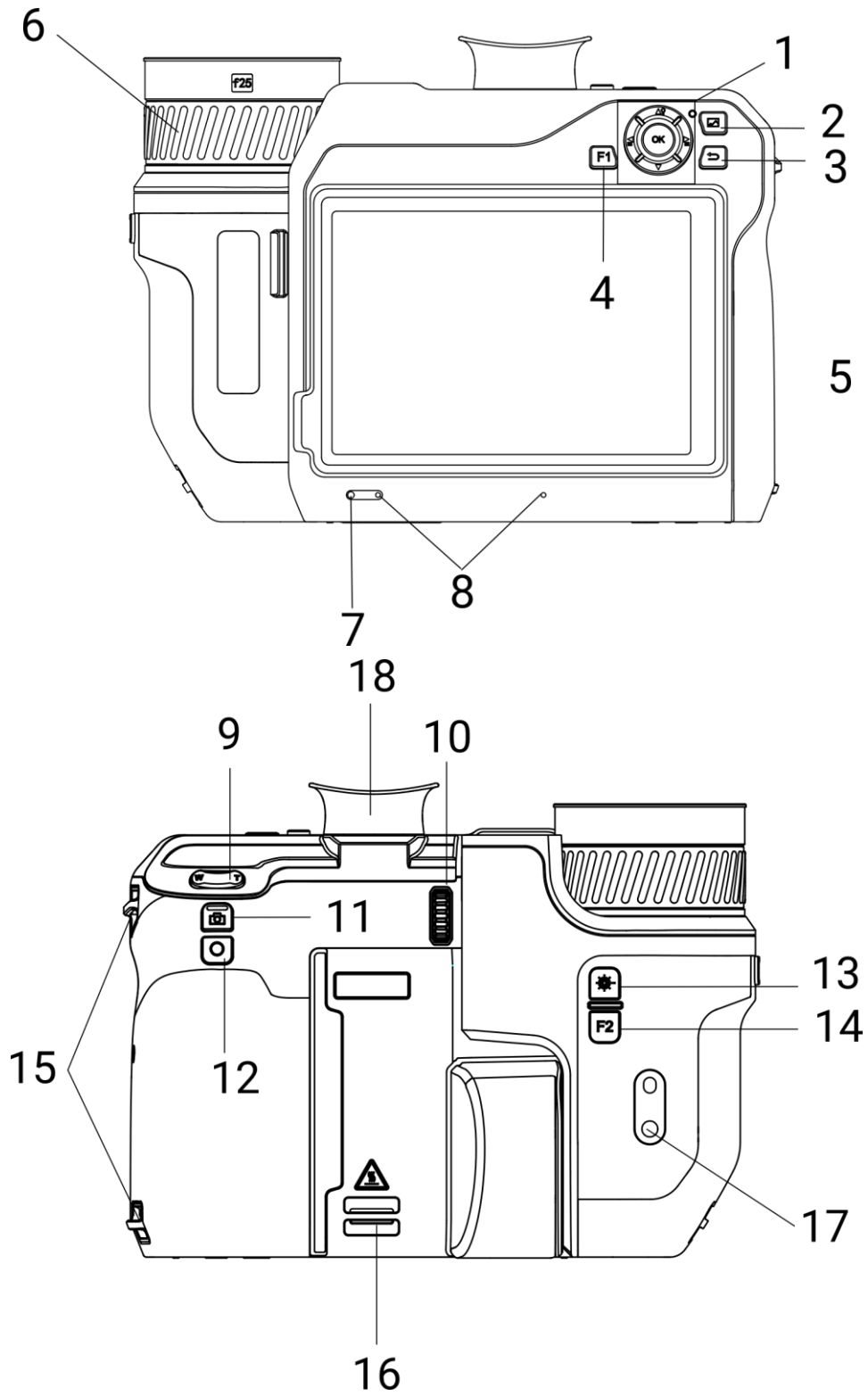

II

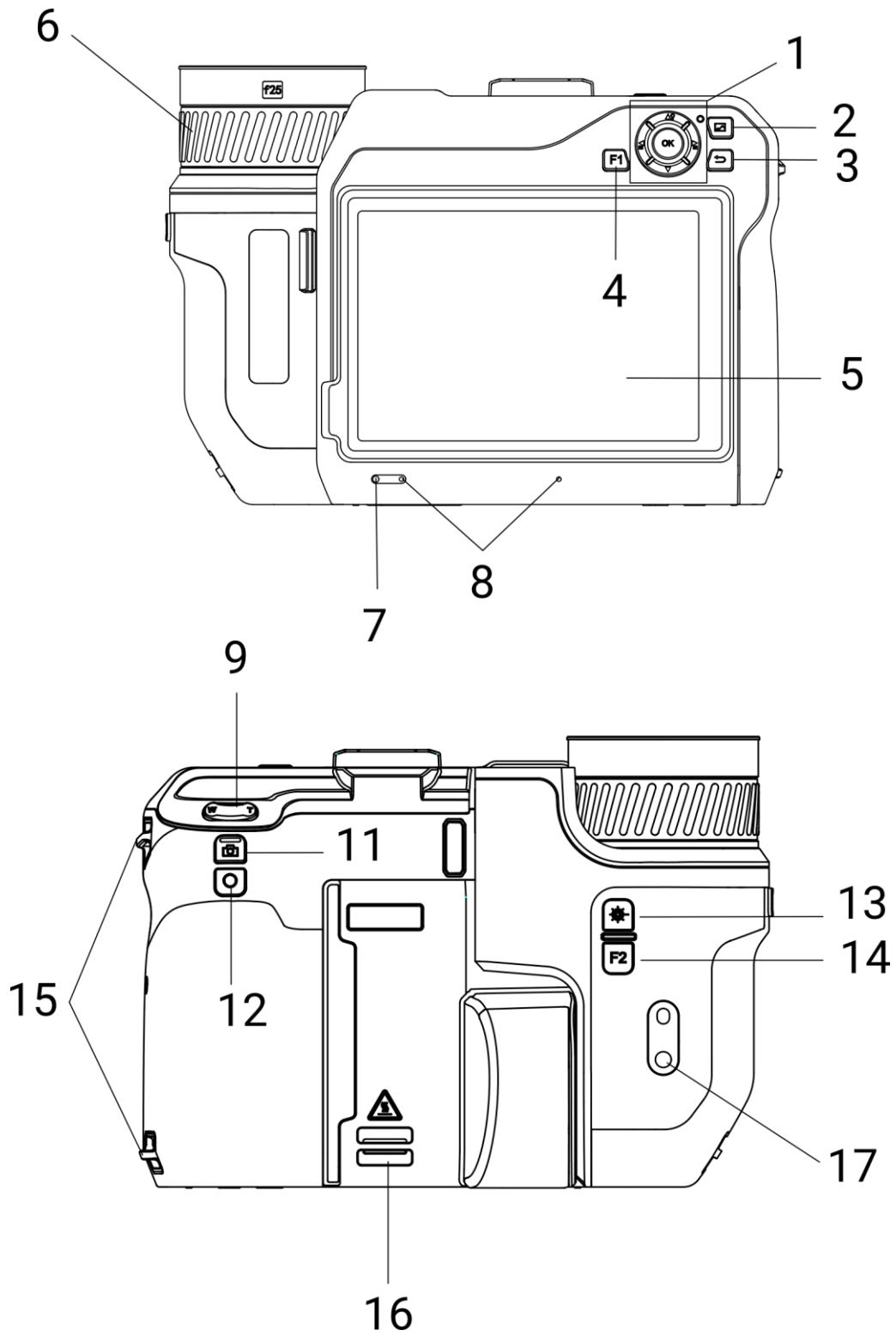

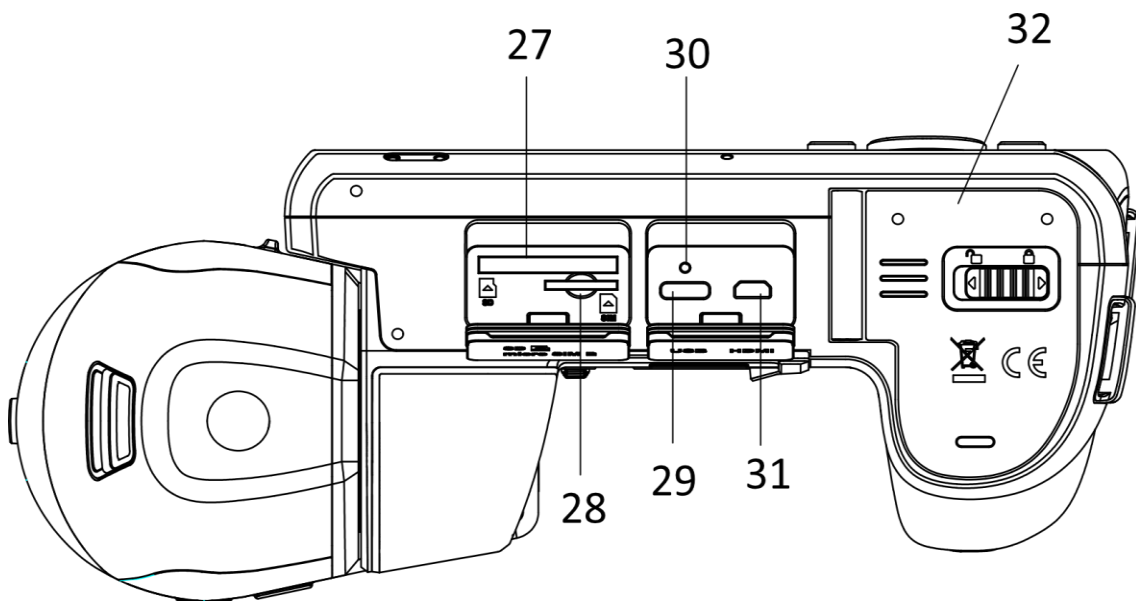
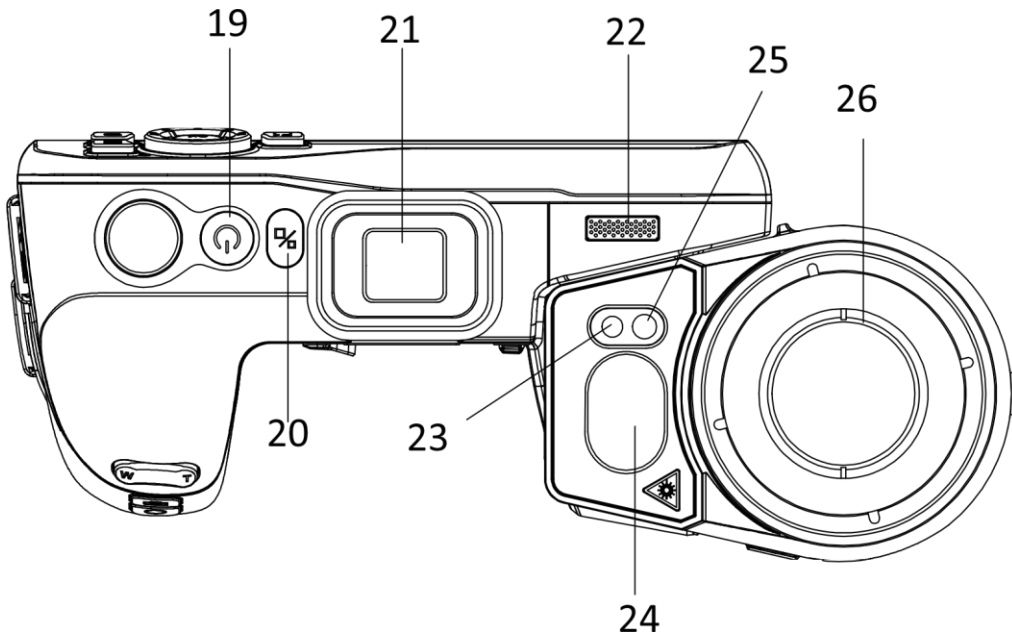

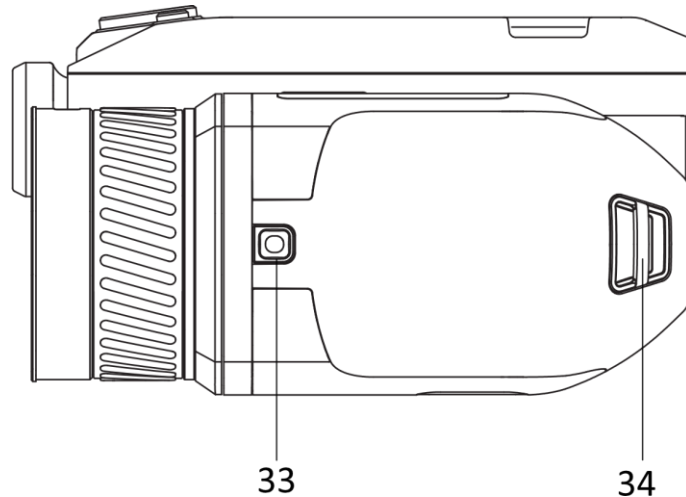

Figure 1-1 Buttons and Interfaces

Table 1-1 Button and Interface Description

No.	Description	Function
1	Navigation Button	Menu Mode: ● Press Δ , ∇ , \triangleleft , and \triangleright to select parameters. ● Press OK to confirm. Non-Menu Mode: ● Press Δ to turn on/off the LED light supplement. ● Press \triangleleft and \triangleright to adjust focus.
2	File Button	Press to enter albums.
3	Back Button	Exit the menu or return to previous menu.
4 & 14	Function Button	Press to use the custom function.
5	Touch Screen	● Show the live view interface. ● Touch-screen operation.
6	Focus Ring	Adjust focus to find clear targets.
7	Light Sensor	Sense the ambient brightness.
8	Microphone	To add voice note.
9	Zoom Button	Press T to zoom in, and press W to zoom out.
10	Diopter Adjustment Wheel	Adjust the dioptic correction for the viewfinder.
11	Capture Button	● Press: capture snapshots/stop recording

Handheld Thermography Camera User Manual

No.	Description	Function
		<ul style="list-style-type: none"> ● Hold: start recording
12	Focus Button	Press to start focus.
13	Laser Button	<ul style="list-style-type: none"> ● Press: measure the distance with laser once ● Hold: measure the distance with laser continuously
15	Hand Strap Attachment Point	Mount the hand strap.
16 & 34	Neck Strap Attachment Point	Mount the neck strap.
17	Tripod Mount	Mount the tripod.
18	Viewfinder	View live view through the viewfinder. See Display Switch Button.
19	Power Button	<ul style="list-style-type: none"> ● Press: standby mode/wake up device ● Hold: power on/off
20	Display Switch Button	Switch the LCD and the Viewfinder.
21	Eyepiece Plug	Protect the eyepiece.
22	Loudspeaker	Play voice note and voice alarm.
23	Optical Lens	View the optical image.
24	Laser Distance Meter	Measure the distance with laser.
25	Supplement Light	Increase ambient brightness in dark environment.
26	Thermal Lens	View the thermal image.
27	Memory Card Slot	Insert the memory card in it.
28	<i>SIM Card Slot</i>	<i>Not Available.</i>
29	Data Exchange Interface	Charge the device or export files with supplied cable.
30	Indicator	<p>Indicate the charging status of the device.</p> <ul style="list-style-type: none"> ● Solid red: charging normally ● Flashing red: charging exception ● Solid green: fully charged

Handheld Thermography Camera User Manual

No.	Description	Function
31	Micro HDMI Interface	Connect the device with HDMI cable. A cable converter (HDMI Type D to HDMI Type A) is included in the carrying case.
32	Battery Compartment	Install the battery in it.
33	Lens Release Button	Unlock the interchangeable lens.

Caution

The laser radiation emitted from the device can cause eye injuries, burning of skin or inflammable substances. Before enabling the light supplement function, make sure no human or inflammable substances are in front of the laser lens.

Chapter 2 Preparation

2.1 Cable Connection

Connect the device and power adaptor with a type-C cable to charge the device battery. Alternatively, connect the device and PC to export files.

Steps

1. Lift the cable interface cover.
2. Connect the device and the Type-C cable.

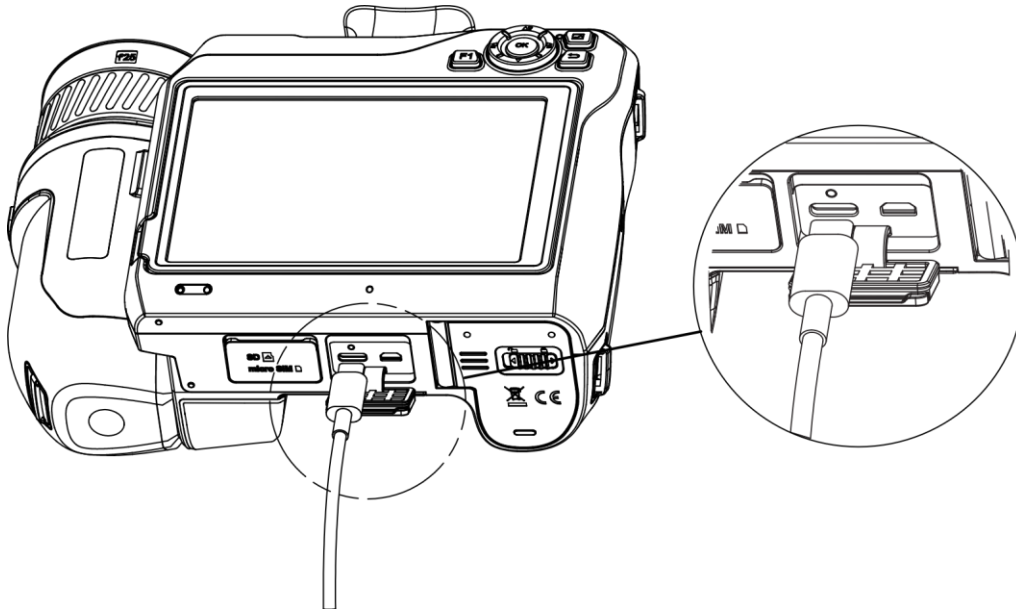

Figure 2-1 Connect to Type-C Cable

2.2 Charge Battery

2.2.1 Remove Battery

Before You Start

Turn off the device before you remove the battery.

Steps

1. Push the battery compartment lock leftwards to unlock the battery compartment, and then open the battery cover.

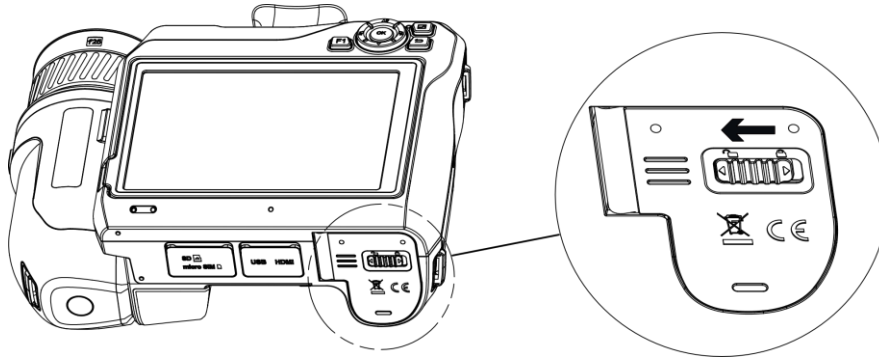

Figure 2-2 Unlock Battery Compartment

2. Push the inner battery lock (in the black circle) leftwards to release the battery.

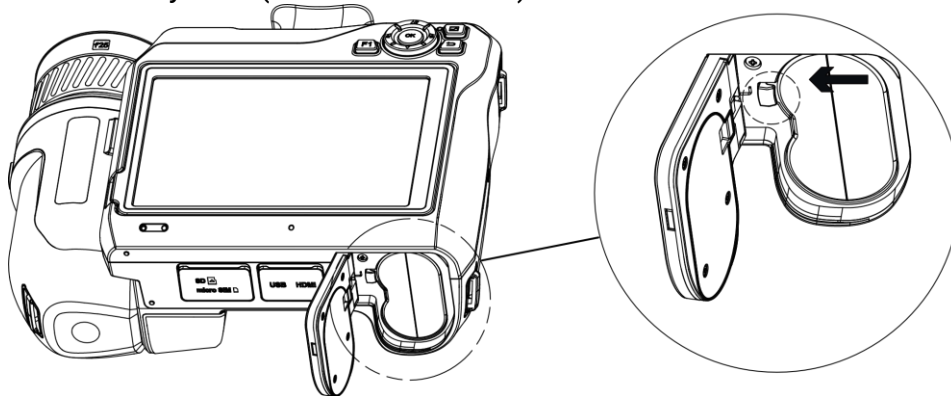

Figure 2-3 Release Battery

3. Take the battery out of the battery compartment.

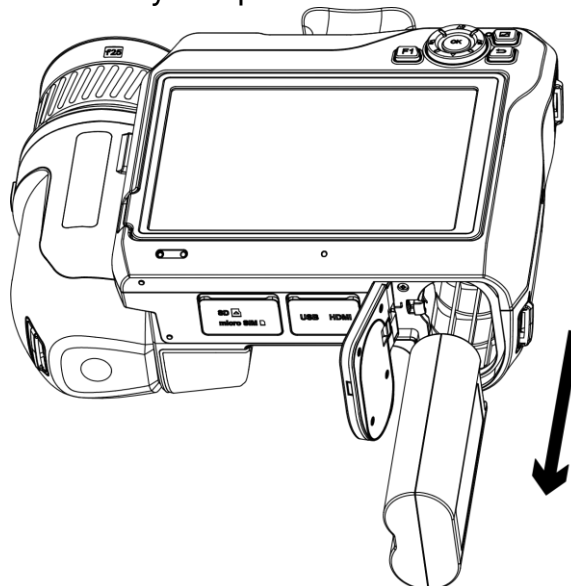

Figure 2-4 Remove Battery

2.2.2 Charge Battery via Charging Base

Note

Please charge the battery with the cable and power adapter supplied by the manufacturer (or according to the input voltage from the specifications).

Steps

1. Put one or two batteries in the charging base.
2. Connect the supplied charging base to the power supply. The indicator in the middle is green if it works properly.
3. The left and right indicators show the charging status of the batteries.
 - Solid red: charging normally.
 - Solid green: fully charged.
4. Draw the battery from the charging base, and disconnect charging base from the power supply.

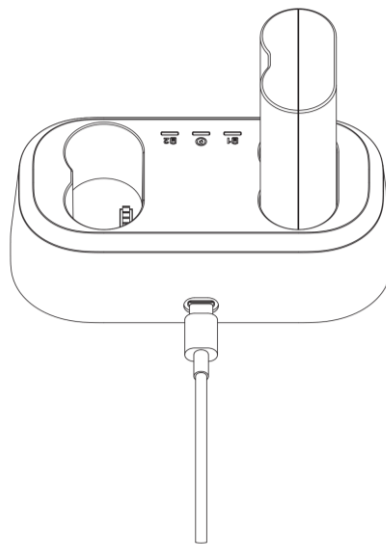

Figure 2-5 Charge Battery via Charging Base

2.3 Change Interchangeable Lens

An interchangeable lens is a thermal lens that can be mounted to the device for obtaining different FOVs, scene scopes, and temperature measurement ranges.

Before You Start

- Purchase a suitable interchange lens recommended by the device manufacturer.
- The device pops up a window to show the lens information or the calibration program when detecting a mounted lens.

Steps

1. Press the lens release button and turn the interchangeable lens anticlockwise until it stops.

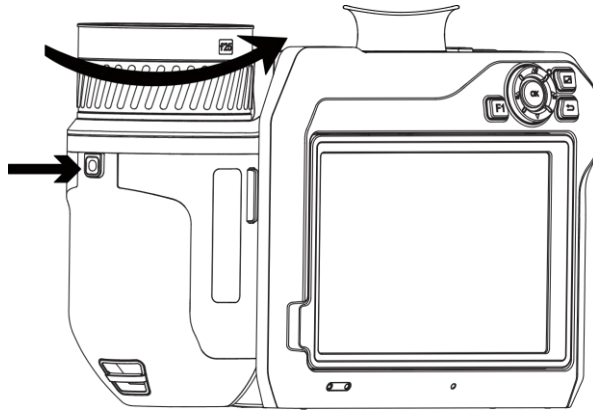

Figure 2-6 Release Lens

2. Remove the interchangeable lens carefully.

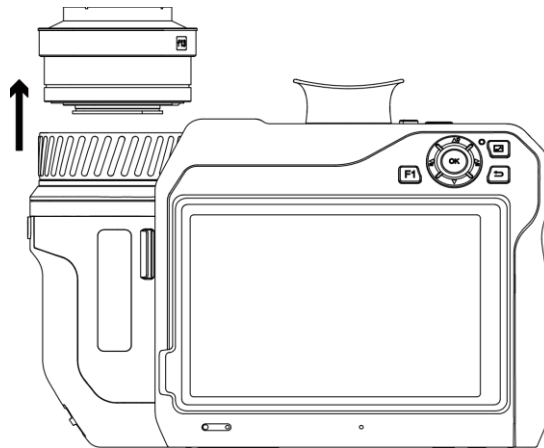

Figure 2-7 Remove Lens

3. Align the two white index marks on the device and the lens.

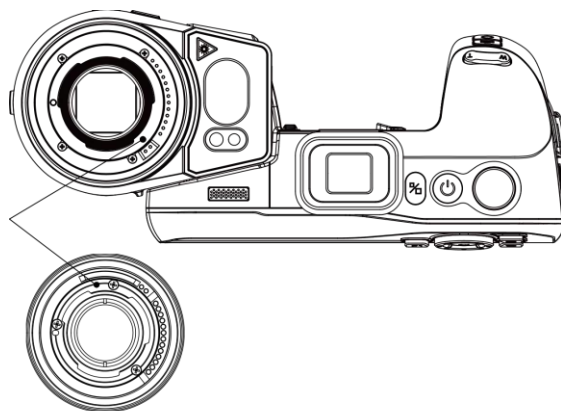

Figure 2-8 Align White Marks

4. Push the lens into position.

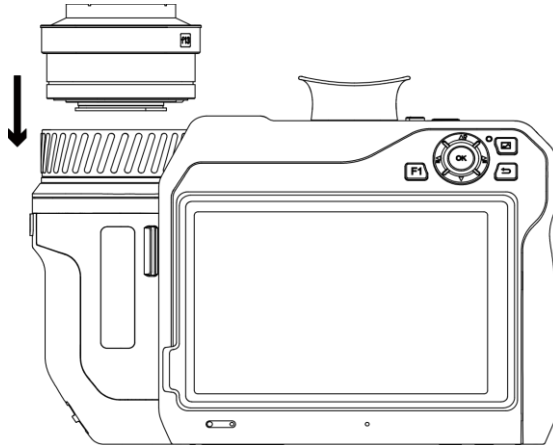

Figure 2-9 Mount Lens

5. Rotate the lens clockwise to fix it. The lens makes a click when it locks in place.

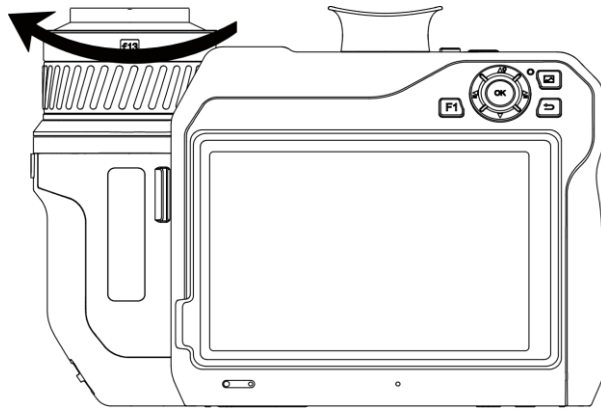

Figure 2-10 Fix Lens

Note

- Dust on the detector may cause blemishes in the image. If you can find the dust on the detector, use pressurized air from a compressed air canister to blow it off; but if you cannot find the dust, we recommend you contact your dealer or the nearest service center for cleaning.
 - A prompt pops up on the interface if the lens is not calibrated to the camera. Please contact the dealer or the nearest service center for lens calibration, or the temperature measurement accuracy is affected.
-

2.4 Mount Hand Strap

Steps

1. Thread the hand strap through the hand strap clutch.



Figure 2-11 Thread Hand Strap

2. Insert one end of the hand strap through the two hand strap attachment points.

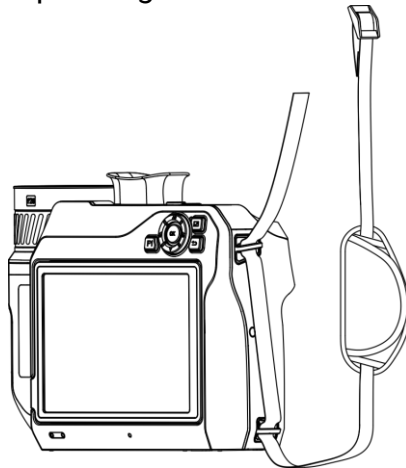

Figure 2-12 Thread Hand Strap Through Attachment Points

3. Thread hand strap through the hand strap buckle, and fasten the hand strap.

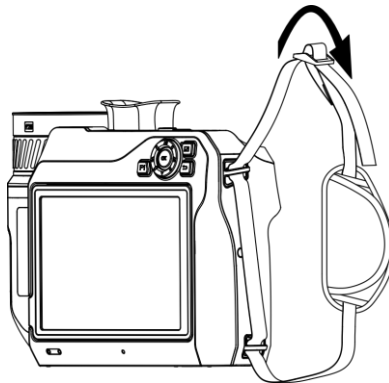

Figure 2-13 Fasten Hand Strap

4. Adjust the tightness of the hand strap as needed.

2.5 Mount Neck Strap

Steps

1. Insert one end of the neck strap through a neck strap attachment point.
2. Thread the neck strap through the buckle, and fasten the neck strap.

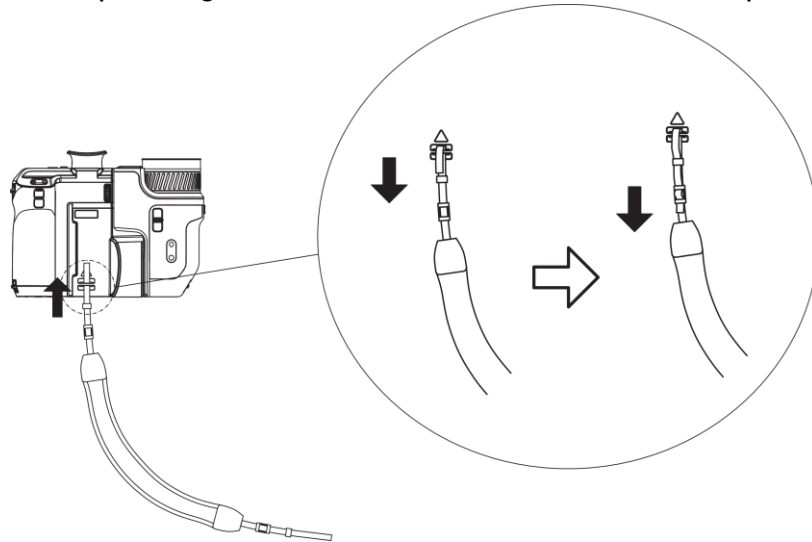

Figure 2-14 Fasten Hand Strap

3. Repeat above steps to complete mounting the neck strap.

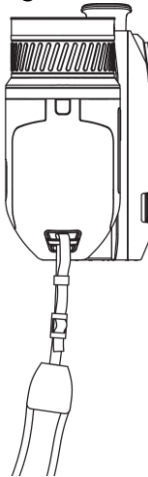

Figure 2-15 Install the Other End

2.6 Tilt Lens and Screen

You can tilt the lens and screen for different observation angles, as shown in Figure 2-11.

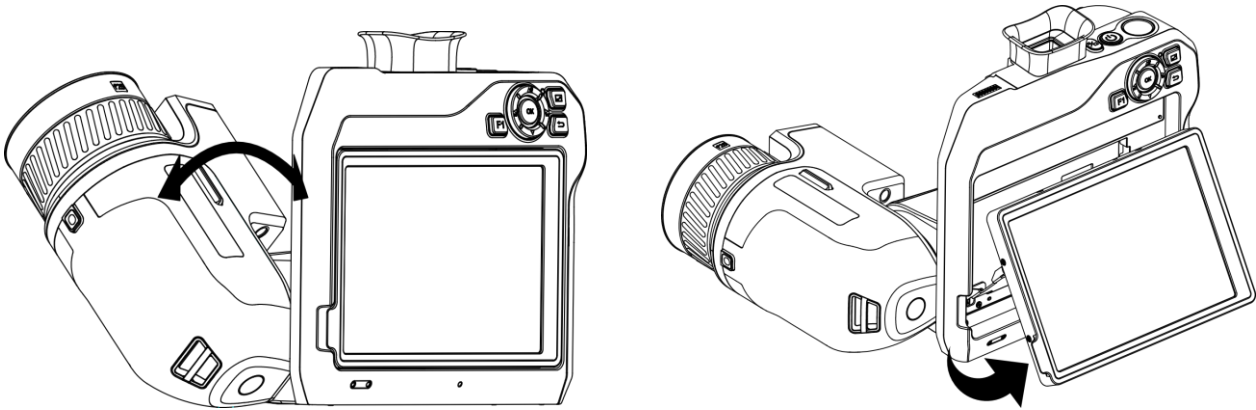



Figure 2-16 Tilt Lens and Screen

2.7 Power On/Off

Power On

Remove the lens cover, and hold  for over three seconds to turn on the device. You can observe the target when the interface of the device is stable.

Note

It may take at least 30 s until the device is ready for using when you power on it.

Power Off

When the device is turned on, hold  for three seconds to power off the device.

Auto Power-off

Select , and go to **Device Settings > Auto Power-off** to set the automatic shutdown time for device as required.

2.8 Sleep and Wake

Sleep and wake function is used to save energy and increase battery time.

Sleep and Wake Manually

Press  to enter sleep mode and press it again to wake the device up.

Set Auto Sleep

Select , and go to **Device Settings > Auto Sleep** to set waiting time before auto sleep. When there is no button pressing or screen tapping operation on device for more than the set waiting time, device enters sleep mode automatically.

Press  to wake the device up.

Device Sleep, Scheduled Capture and Video Recording

When the device is recording a video clip or on scheduled capturing, auto sleep will not be triggered. However, press  will stop the video recording or scheduled capture and force the device into sleep mode.

2.9 Operation Method

The device supports both touch-screen control and button control.

Touch-Screen Control

Tap the screen to set parameters and configurations.

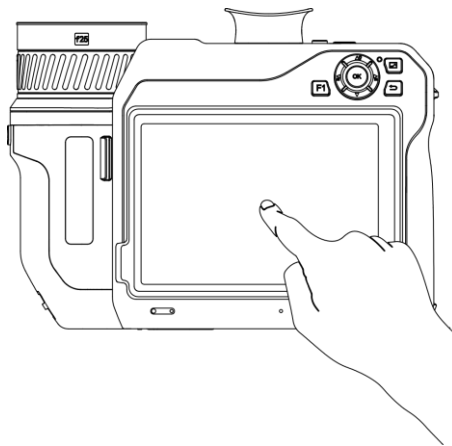

Figure 2-17 Touch-screen Control

Button Control

Press the navigation buttons to set parameters and configurations.

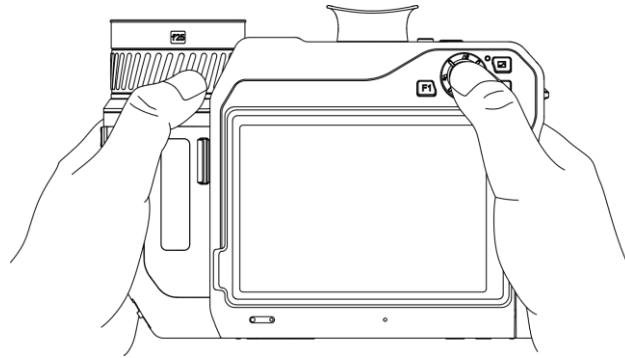

Figure 2-18 Button Control

- In menu mode, press Δ , ∇ , \triangleleft , and \triangleright to select parameters.
- Press **OK** to confirm.

2.10 Menu Description

In the observation interface, tap the screen to show the menu bar, and swipe down to call the swipe-down menu.

2.10.1 Live View Interface

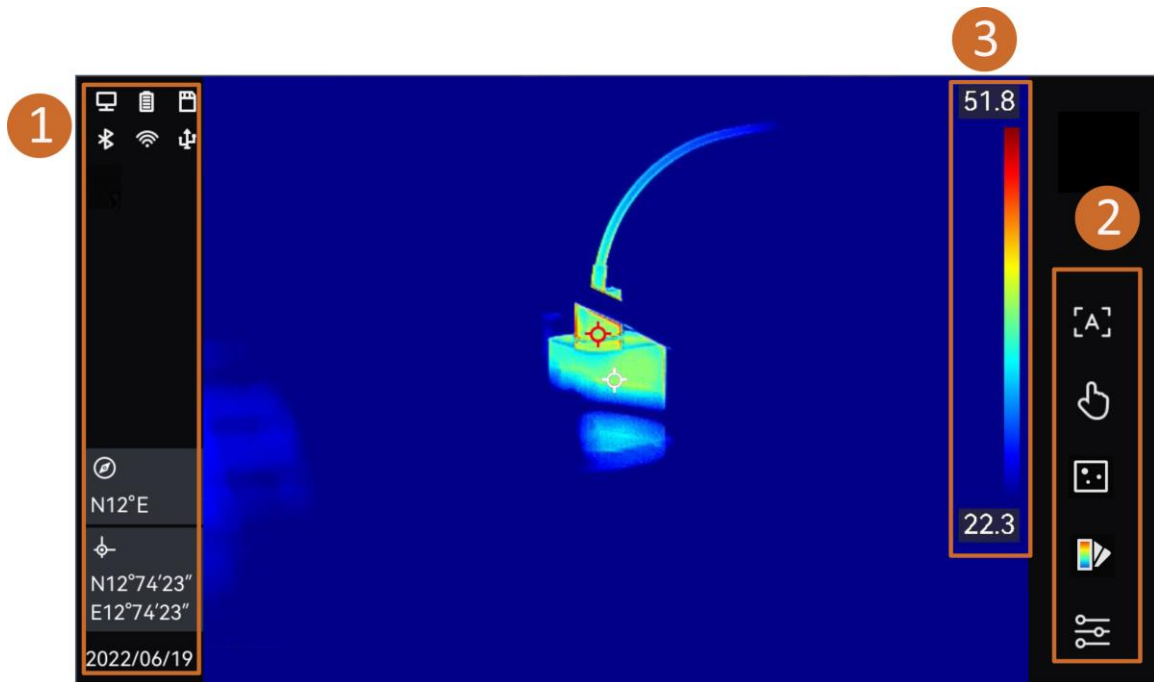

Figure 2-19 Live View

Handheld Thermography Camera User Manual

Table 2-1 Live View Interface Description

No.	Descriptions
1	Status bar, where device working status, such as, battery and connections, are displayed.
2	Shortcut bar. Focus mode, level & span mode, display mode, palettes, and measurement settings support quick operation.
3	<p>Palette bar and display temperature range. The upper and lower values of the palette bar represent the max. temperature and the min. temperature of the current display temperature range.</p> <hr/> <p> Note If a "~" appears before a temperature value, it means that your device is not well prepared for accurate temperature measurement. Take target temperatures when the sign disappears.</p> <hr/>

Table 2-2 Description of Status Display















Status Display	Description
	Battery Status
	The device is connected to PC via Type-C cable.
	Wi-Fi is connected.
	Memory Card is inserted.
	Bluetooth is on.
	Interchangeable Lens is mounted on the device and the interchangeable lens type is on the bottom right of the icon.
	The inspection data is transmitting to the device.
	Cast Screen is on.
	Compass is on. The number stands for the calibration level. Numbers smaller than 3 mean that the compass is not properly calibrated and the direction displayed might not be correct.

Table 2-3 Description of Shortcut Function







Icon	Description
	Tap to switch focus mode.
	Tap to switch manual and auto level & span.
	Tap to switch display mode.
	Tap to switch palettes.
	Tap to set temperature measurement parameters such as humidity, emissivity, distance, and temperature.

2.10.2 Main Menu



Figure 2-20 Main Menu

Table 2-4 Description of Main Menu

Icon	Description	Icon	Description
	Shutter		Temperature Measurement Tool
	Level & Span		Display Mode
	Palettes		Settings

2.10.3 Swipe-Down Menu

In live view interface, swiping on screen from upper to lower to call the swipe-down menu. With this menu, you can turn on/off device function, change display theme, and adjust screen brightness.

Note

Tap and hold Wi-Fi, Hotspot, and Bluetooth icon in swipe-down menu to enter corresponding configuration interface.

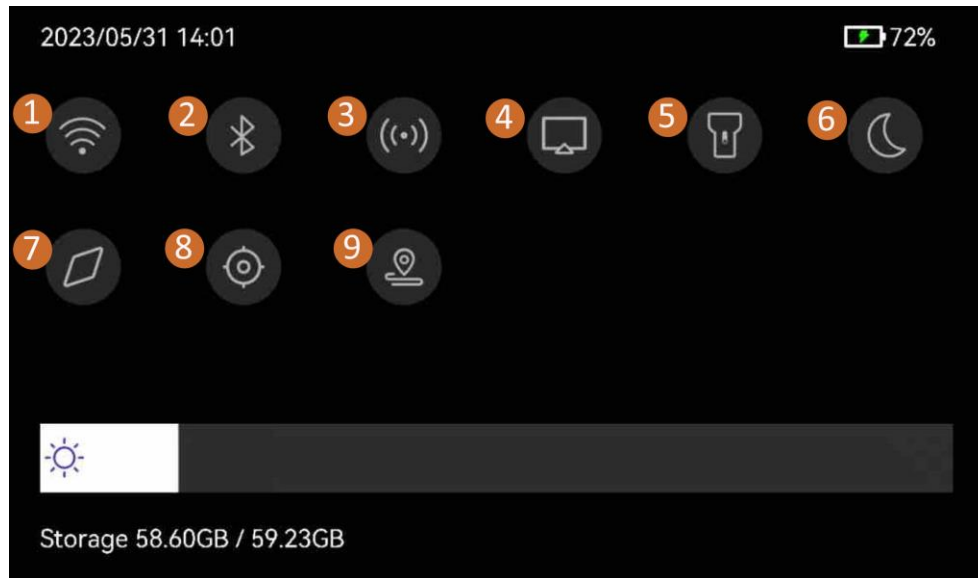

Figure 2-21 Swipe-down Menu

- | | | |
|---------------|--------------|--------------------|
| ① Wi-Fi | ② Bluetooth | ③ Hotspot |
| ④ Cast Screen | ⑤ Flashlight | ⑥ Dark/Bright Mode |
| ⑦ Compass | ⑧ GPS | ⑨ Inspection Mode |

Chapter 3 Display Settings

Note

Your device will periodically perform a self-calibration to optimize image quality and measurement accuracy. In this process the image will pause briefly and you'll hear a "click" as a shutter moves in front of the detector. The self-calibration will be more frequent during start up or in very cold or hot environments. This is a normal part of operation to ensure optimum performance for your device.

3.1 Focus

Adjust the lens focal length properly before you set any other configurations, or it may affect the image display and temperature accuracy.

3.1.1 Focus Lens

Steps

1. Power on the device.
2. Aim the device lens to the appropriate scene.
3. Adjust the focus ring clockwise or anticlockwise until the target is clear.

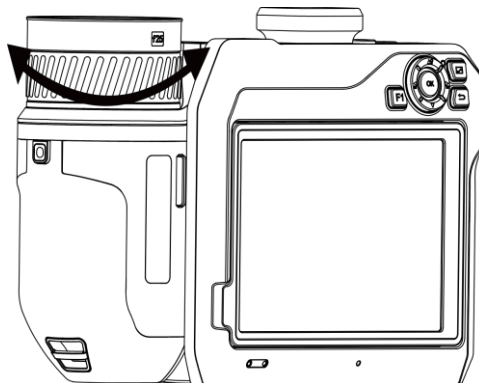

Figure 3-1 Focus Lens

Note

DO NOT touch the lens, or the imaging effect may be affected.



3.1.2 Laser Assisted Focus

Aim the laser to the target and the device focuses automatically.

Before You Start

- It is recommended to use this function in a non-glare environment, such as indoor environment.
- The target should have good light reflection, such as white paper and cables.

Steps

1. Enable **Laser Assisted Focus** by the following ways:
 - Select , and go to **Device Settings** > **Focus** > **Focus Mode** to enable **Laser Assisted Focus**.
 - In live view, tap the focus shortcut key in shortcut bar and switch to **Laser Assisted Focus** .
 2. In the live view interface, aim image center at the target and press  to finish focus.
 3. When you see a red dot display in the image center and a laser dot at the target, release the trigger to start focusing automatically.
-

Danger



The laser radiation emitted from the device can cause eye injuries, burning of skin or inflammable substances. Prevent eyes from direct laser. Before enabling the function, make sure no human or inflammable substances are in front of the laser lens.

4. Optional: If the focusing effect is not satisfactory, slightly adjust the focus ring for better image.

3.1.3 Auto Focus

The device focuses automatically in current scene by comparing the brightness, contrast, etc. In this mode, you can pull the trigger or touch the screen to focus.

Steps

1. Enable **Auto Focus** by the following ways:
 - Select , and go to **Device Settings** > **Focus** > **Focus Mode** to enable **Auto Focus**.
 - In live view, tap the focus shortcut key in shortcut bar and switch to **Auto Focus** .
 2. In the live view interface, aim image center at the target and press  to finish focus.
The device adjust its focus on targets in the image center.
 3. Optional: If you want to switch the focus to other objects, tap the desired screen area to adjust the focus.
-

Note

- DO NOT adjust the focus ring when the device is auto focusing, otherwise it will interrupt the auto focusing process.
 - If the target is not clearly focused in this mode, adjust the focus ring to fine-tune the image.
-

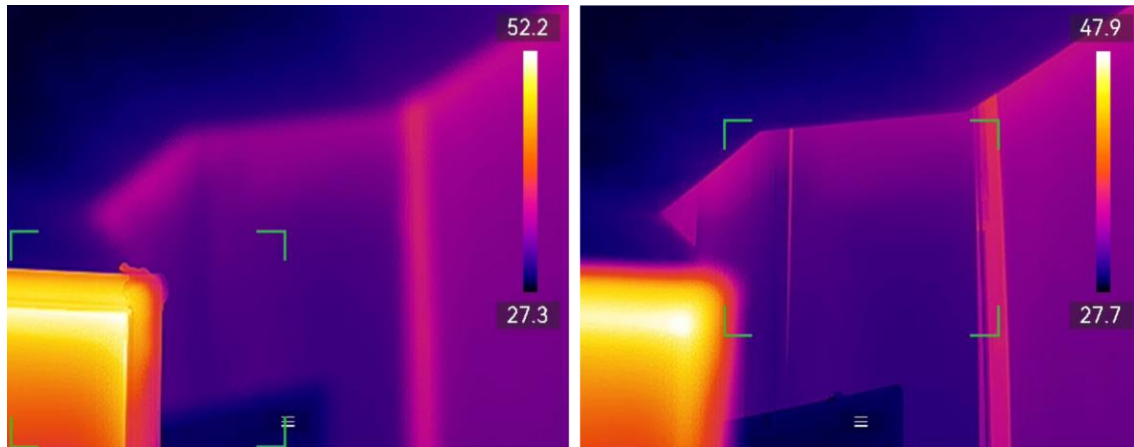

Figure 3-2 Switch Focus Object

3.1.4 Continuous Autofocus

In continuous autofocus mode, the device focuses on the target automatically to make the scene clear. Use this mode when the device is stationary.

Caution

Disable continuous autofocus mode when the device is moving, or it may affect the device function.

You can enable **Continuous Autofocus** by the following ways:

- Select , and go to **Device Settings > Focus > Focus Mode** to enable **Continuous Autofocus**.
- In live view, tap the focus shortcut key in shortcut bar and switch it to **Continuous Autofocus** [C].

Then aim the device at the target, and the device focuses automatically.

Note

Focus ring adjustment does not take effect in this mode.

3.1.5 High Temperature Priority

Enable the high temperature priority function if you want to focus on the high temperature

object in the observation scene.

Select , and go to **Device Settings** > **Focus** to enable **High Temperature Priority**.



Note

The high temperature priority function is only supported in auto focus mode and continuous autofocus mode.

3.2 Set Screen Brightness

The device supports auto or manual screen brightness adjustment.

Table 3-1 Screen Brightness Adjustment

Method	Operation
Manual	Select  , and go to Settings > Device Settings > Screen Brightness to adjust the screen brightness. Or tap  , and drag it to adjust the screen brightness.
Auto	Select  , and go to Settings > Device Settings > Screen Brightness to enable Auto . Device adjusts the screen brightness automatically when the ambient brightness changes.

3.3 Set Display Mode

You can set the thermal/optical view of the device. **Thermal, Fusion, PIP, Visual, and Blending** are selectable.

Steps

1. Switch the display mode by the following ways:

- Select  from the main menu, and tap the icons to select a display mode.
- In live view, tap the focus shortcut key in shortcut bar and switch display mode.



In thermal mode, the device displays the thermal view.



In fusion mode, the device displays the overlay effect of optical image and thermal image.



In PIP (Picture in Picture) mode, the device displays thermal view inside the optical

view.

Note

You can drag the corners of the PIP frame to move, enlarge, or contract it.



In visual mode, the device displays the optical view.



In blending mode, the device displays the mixture view of thermal channel and optical channel. You can adjust the **Level** to change the optical-thermal ratio. The lower the value is, the denser the optical effect is.



2. Press  to exit.

3.4 Set Palettes

The palettes allow you to select the desired colors.

Steps

1. Switch palettes by the following ways:

- Select  from the main menu, and tap the icons to select a palette.
- In live view, tap  in shortcut bar and switch palettes.

White Hot

The hot part is light-colored in view.

Black Hot

The hot part is black-colored in view.

Rainbow

The target displays multiple colors. It is suitable for scene without obvious temperature difference.

Ironbow

The target is colored as heated iron.

Red Hot

The hot part is red-colored in view.

Fusion

The hot part is yellow-colored and the cold part is purple-colored in view.

Rain



The hot part in the image are colored, and the else is blue.

Blue Red

The hot part in the image is colored red, and the else is blue.

2. Press  to exit the setting interface.

Note

You can also press  and  to switch the palettes.

3.4.1 Set Alarm Mode Palettes

Alarm mode palettes allows to mark the targets of certain temperature range with a different color from the rest.

Steps











1. Select  from the main menu.
2. Tap the icons to select an alarm tool type.

Table 3-2 Icon Description

Icon	Alarm Mode	Description
	Above Alarm	Set the alarm temperature, and the targets with the temperature higher than the set value are displayed in red.
	Below Alarm	Set the alarm temperature, and targets with the temperature lower than the set value are displayed in blue.
	Interval Alarm	Set the alarm temperature section (e.g., 90 °C to 150 °C), and targets with the temperature in the range are displayed in yellow.
	Insulation Alarm	Set the alarm temperature section (e.g., 90 °C to 120 °C), targets with the temperature out of the section (e.g., 70 °C or 125 °C) are displayed in purple or blue.

3. Set a temperature range.
 - Press  and  to select between upper limit and lower limit. Press  and  to adjust the temperature.
 - Tap on the screen to select an interest area. The device automatically adjust the upper and lower temperature limit of the selected scene. Press  and  to fine-tune

the temperature.

4. Press  to exit.

3.4.2 Set Focus Mode Palettes

Focus mode palettes allows to mark the targets of certain temperature range with fusion palettes and the others with white hot palettes.

Steps











1. Select  from the main menu.
2. Tap the icons to select an alarm tool type.

Table 3-3 Icon Description

Icon	Palettes Mode	Description
	Above Focus	Set the temperature threshold, and the targets with the temperature higher than the set value are displayed with fusion palettes.
	Below Focus	Set the temperature threshold, and targets with the temperature lower than the set value are displayed with fusion palettes.
	Interval Focus	Set the temperature range (e.g., 90 °C to 150 °C), and targets in the range are displayed with fusion palettes.

3. Set a temperature range.

- Press  and  to select between upper limit and lower limit. Press  and  to adjust the temperature.
- Tap on the screen to select an interest area. The device automatically adjust the upper and lower temperature limit of the selected scene. Press  and  to fine-tune the temperature.

4. Press  to exit.

3.5 Adjust Level & Span

Set a temperature range and the palette only works for targets within the temperature range. You can adjust the temperature range.

Steps

1. Select  from the main menu.

2. Select auto adjustment  or manual adjustment .

Note





Tap  in the shortcut bar to quickly switch between auto and manual level & span.

3. For **Manual** mode, go to **Local Settings > Measurement Settings > Manual Level and Span Mode** to choose a preferred mode. **Level Only** and **Level & Span** are selectable.



- **Level Only:** You can manually adjust the maximum temperature and the minimum temperature respectively to expand or reduce the temperature range.
- **Level & Span:** You can adjust the maximum temperature and the minimum temperature at the same time while remaining the same temperature range.

Auto Adjustment

The device adjusts temperature range parameters automatically.

- Tap on an interest area of the screen. A circle is displayed around the area, and the temperature range readjusts to show as many details of the area as possible.
- Press  and , or tap on the value on screen to lock or unlock a value.
- Press  and , or scroll the adjustment wheel on the screen to fine-tune the max. temperature and the min. temperature respectively.
- Tap **OK** to finish.

Level Only

- Tap on an interest area of the screen. A circle is displayed around the area, and the temperature range readjusts to show as many details of the area as possible.
- Press  and  to fine-tune the max. temperature and the min. temperature respectively.
- Tap **OK** to finish.

Level & Span

4. Tap **OK** to confirm.

3.5.1 Color Distribution

Color distribution function provides different image display effects in auto level & span. Liner and histogram color distribution modes can be selected for different application scenes.

Steps

1. Select , and go to **Device Settings > Measurement Settings > Color Distribution**.
2. Select a color distribution mode.

Linear

Linear mode is used to detect small high temperature targets in low temperature background. Linear color distribution enhances and displays more details of high temperature targets, which is good for checking small high temperature defective areas such as cable connectors.

Histogram

Histogram mode is used to detect temperature distribution in large areas. Histogram color distribution enhances high temperature targets and remains some details of low temperature objects in the area, which is good for discovering small low temperature targets such as cracks.

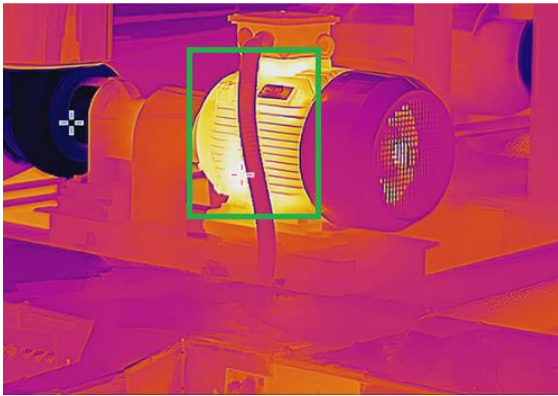

Linear

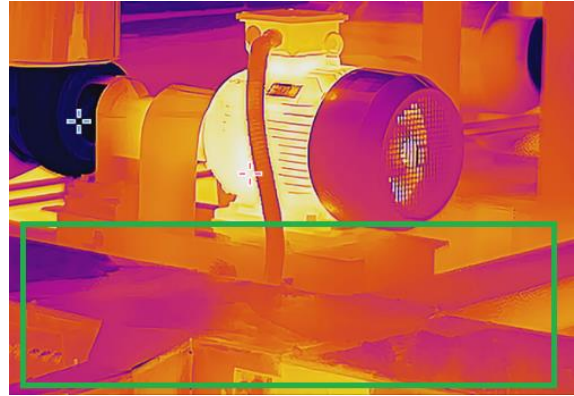

Histogram

3. Press  to exit.

Note

This function is only supported in auto level & span.

3.6 Adjust Digital Zoom

In the live view interface, press **T** and **W** to zoom in or zoom out by 0.1× continuously. Hold **T** and **W** to zoom in or zoom out by 1×, 2×, etc.

3.7 Display OSD Info

Select , and go to **Display Settings** to enable the information on-screen display.

Status Icon

The device status icons, for example, battery status, memory card, hotspot, etc.

Time and Date

Device time and date.

Parameters

Thermography parameters, for example, target emissivity, temperature unit, etc.

Distance

Laser measurement result.

Brand Logo

The brand logo is a manufacturer logo displayed on the upper right corner of the screen.

Chapter 4 Temperature Measurement

The temperature measurement function provides the real-time temperature of the scene and display it on the left of your screen. This function is turned on by default.

Note

Your device will periodically perform a self-calibration to optimize image quality and measurement accuracy. In this process the image will pause briefly and you'll hear a "click" as a shutter moves in front of the detector. The self-calibration will be more frequent during start up or in very cold or hot environments. This is a normal part of operation to ensure optimum performance for your device.

4.1 Set Measurement Parameters

You can set measurement parameters to improve the accuracy of temperature measurement.

Steps

1. Select , and go to **Measurement Settings**.
2. Set **Temperature Range**, **Emissivity**, etc.

Temperature Range

Select the temperature measurement range. The device can detect the temperature and switch temperature range automatically in **Auto Switch** mode.

Emissivity

Refer to ***Common Material Emissivity Reference*** to set the emissivity of your target.

Reflection Temperature

If any object (not the target) of high temperature is in the scene, and the target emissivity is low, set the reflection temperature as the high temperature to correct the temperature effect.

Distance

The distance between the target and the device. You can customize the target distance or select the target distance as **Near**, **Middle**, or **Far**.

Humidity

Set the relative humidity of current environment.

External Optics Transmittance

Set the optics transmittance of external optical material (e.g.: germanium window) to improve the temperature measuring accuracy.

External Optics Temperature

Set temperature of the external optical material (e.g.: germanium window).

Note

When you install a macro lens, the device switches to macro mode automatically. In macro mode, settings such as display mode, distance, and optical transmissivity cannot be modified.

3. Return to previous menu to save the settings.



Note

Select , and go to **Device Settings > Device Initialization > Remove All Measurement Tools** to initialize the temperature measurement parameters.

4.2 Set Image Measurement

You can set three types of temperature measurement tools.

Table 4-1 Icon Description

Icon	Description
	Center Spot Temperature Measurement
	Hot Spot Temperature Measurement
	Cold Spot Temperature Measurement

The setting methods of center spot, hot spot, and cold spot temperature measurement are all the same. Here is the example of image measurement.

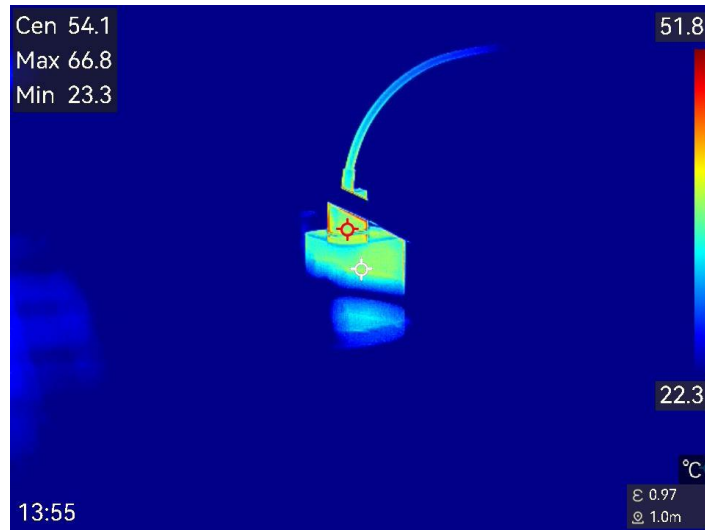

Figure 4-1 Image Measurement

4.3 Set Measurement Tool

You can set temperature measurement parameters to improve the accuracy of temperature measurement.

Before You Start

Set parameters such as **Humidity**, **External Optics Transmittance** and **Reflection Temperature**. For detailed explanations, see [Set Measurement Parameters](#).

Steps

1. Tap  to call the measurement tool bar.
3. Select a type of temperature measurement tool.

- | | |
|------------------------------|--|
| Custom Spot | For configuring custom spot tools, see <u>Measure by Custom Spot</u> . |
| Line | For the configuring line tools, see <u>Measure by Line</u> . |
| Rectangle | For the configuring rectangle tools, see <u>Measure by Rectangle</u> . |
| Circle | For the configuring circle tools, see <u>Measure by Circle</u> . |
| ΔT | For the configuring ΔT tools, see <u>Measure ΔT and ΔT Alarm</u> . |



Figure 4-2 Temperature Measurement Tools



What to do next

Set temperature alarm, then alarm actions such as audible warning and flashing alarm will be triggered when the tested temperature exceeds the set alarm value. See [Temperature Alarm](#).

4.3.1 Measure by Custom Spot

The device can detect the temperature of a custom spot.

Steps

1. Tap  to add a default spot.
3. Move the spot with the navigation buttons, or tap on the touch-screen to select a spot and move it.
4. Tap  to modify temperature measurement parameters.

Emissivity

Refer to [Common Material Emissivity Reference](#) to set the emissivity of your target.

Distance

Set the distance between the target and the device.

Temp.

Tap to display or hide the temperature measurement result.

5. Press .





The temperature of custom spot (e.g. P1) displays P1: XX.

Note

If the tool-specific emissivity and distance are set, the measurement is conducted based on the parameters. Otherwise, the parameters set from **Measurement Settings** are used for measurements.

6. Repeat the above steps to set other custom spots.

Note

- At most ten custom spots are supported.
 - Drag the spot tool list on the left of the screen, or press , ,  and  to view the whole tool list.
-

7. Optional: Modify the set custom spot tools, hide or display the tools and measurement results, etc.



Tap to enter the editing interface and modify temperature

measurement parameters such as emissivity and distance.



Tap to hide or display the tool and measurement results.



Tap to delete the tool.

8. Press to save and exit.

4.3.2 Measure by Line

Steps

1. Tap to generate a default line.

Note

Only one line tool is supported.

2. Move the line to the required position.

- Tap the line, and press , , and to move the line up/down/left/right.
- Tap the line on touch-screen and drag it to the required position.

3. Adjust the length of the line.

- Tap the end of the line, and press , , and to extend or shorten the line.
- Tap and drag the end of the line to extend or shorten it.

4. Tap to modify temperature measurement parameters.

Emissivity

Refer to ***Common Material Emissivity Reference*** to set the emissivity of your target.

Distance

Set the distance between the target and the device.

Max./Min./Average Temperature

Tap to enable the temperature types to display. The max. temperature, min. temperature, and average temperature of the line can be displayed on the left of the screen.

5. Press .

Note

If the tool-specific emissivity and distance are set, the measurement is conducted based on the parameters. Otherwise, the parameters set from **Measurement Settings** are used for measurements.

6. Modify the set line tool, hide or display the tool and measurement results, etc.



Tap to enter the editing interface and modify temperature measurement parameters such as emissivity and distance.



Tap to hide or display the tool and measurement results.



Tap to delete the tool.

7. Press to save and exit.

4.3.3 Measure by Rectangle

Steps

1. Tap to generate a default rectangle.
2. Move the rectangle to the required position.
 - Tap the rectangle, and press , , , and to move the rectangle up/down/left/right.
 - Tap and drag the rectangle on touch-screen to move it to the required position.
3. Adjust the size of the rectangle.
 - Tap one corner of the rectangle, and press , , , and to enlarge or contract the rectangle.
 - Tap and drag the corner of the rectangle on touch-screen to enlarge or contract it.
4. Tap to modify temperature measurement parameters.

Emissivity

Refer to ***Common Material Emissivity Reference*** to set the emissivity of your target.

Distance

Set the distance between the target and the device.

Max./Min./Average Temperature

Tap to enable the temperature types to display. The max. temperature, min. temperature, and average temperature of the rectangle area can be displayed on the left of the screen.

6. Press to save the settings.

Note

If the tool-specific emissivity and distance are set, the measurement is conducted based on the parameters. Otherwise, the parameters set from **Measurement Settings** are used for measurements.

7. Repeat the above steps to set other rectangle tools.

Note

At most five rectangle tools are supported.

8. Optional: Modify the rectangle tools, hide or display the tools and measurement results, etc.



Tap to enter the editing interface and modify temperature measurement parameters such as emissivity and distance.



Tap to hide or display the tool and measurement results.













Tap to delete the tool.

9. Press  to save and exit.

4.3.4 Measure by Circle

Steps

1. Tap  to generate a default circle.
2. Move the circle to the required position.
 - Tap the circle, and press , ,  and  to move the circle up/down/left/right.
 - Tap and drag the circle on touch-screen to move it to the required position.
4. Adjust the size of the circle.
 - Tap one point on the circle, and press , ,  and  to enlarge or contract the circle.
 - Tap and drag one point of the circle on touch-screen to enlarge or contract it.
5. Tap  to modify temperature measurement parameters.

Emissivity

Refer to [Common Material Emissivity Reference](#) to set the emissivity of your target.

Distance

Set the distance between the target and the device.

Max./Min./Average Temperature

Tap to enable the temperature types to display. The max. temperature, min. temperature, and average temperature of the circle area can be displayed on the left of the screen.

6. Press  to save the settings.

Note

If the tool-specific emissivity and distance are set, the measurement is conducted based on the parameters. Otherwise, the parameters set from **Measurement Settings** are used for measurements.

7. Repeat the above steps to set other circle tools.

Note

At most five circle tools are supported.

8. Optional: Modify the circle tools, hide or display the tools and measurement results, etc.



Tap to enter the editing interface and modify temperature measurement parameters such as emissivity and distance.



Tap to hide or display the tool and measurement results.



Tap to delete the tool.

9. Press  to save and exit.

4.4 Measure ΔT and ΔT Alarm

By comparing the temperature difference (ΔT) between measurement tools, or between a measurement tool and a certain temperature, device can recognize temperature exception more accurately and rapidly. This function is commonly applied to the temperature measurement of temperature-sensitive targets such as current transformers.

Before You Start

Configure at least one temperature measurement tool.

- For configuring custom spot tools, see ***Measure by Custom Spot***.
- For the configuring line tools, see ***Measure by Line***.
- For the configuring rectangle tools, see ***Measure by Rectangle***.
- For the configuring circle tools, see ***Measure by Circle***.

Steps

1. Tap .
2. Add a ΔT tool.
 - 1) Input a tool name for the ΔT tool in **Name of Tool**.
 - 2) Select **Compared Object**.

Note

You can compare the temperature difference between different or the same measurement tools, between a measurement tool and a number, etc. If you select **Number** as a compared object, input the value manually.

3) Set **Alarming ΔT** .

When the detected ΔT is greater than the set alarming ΔT , device triggers alarms.

4) Tap **OK** to save the settings.

3. Optional: Repeat above steps to set other ΔT tools.

4. Optional: Modify the ΔT tools, hide or display the tools and measurement results, etc.



Tap to enter the editing interface and modify ΔT tool parameters such as emissivity and distance.



Tap to hide or display the ΔT tool and measurement results.



Tap to delete the ΔT tool.

5. Press  to save and exit.

6. Enable **ΔT Alarm**.

1) Select , and go to **Measurement Settings > Alarm Settings**.

2) Tap to enable **ΔT Alarm**.

Note

If you do not enable ΔT Alarm, the alarm linkages also take effect, but the ΔT alarm information will not be uploaded to the surveillance center.

4.5 Temperature Alarm

When the temperature of targets triggers the set alarm, the device will perform configured actions, such as, flashing the rule frame, making an audible warning, or sending notification to the client software.

4.5.1 Set Alarms for Exceptional Temperatures

Alarm actions such as audible warning and flashing alarm are triggered when the tested temperature exceeds the set alarm value.

Steps

1. Select , and go to **Measurement Settings > Alarm Settings**.

2. Tap to enable **Temperature Alarm**.

3. Set the alarm parameters.

Alarm Threshold

When the tested temperature exceeds the threshold, the device sends alarm notification to the client software. It beeps if the audible warning is enabled. The rectangle flashes red if the rectangle tool is configured.

Alarm Linkage

- **Audible Warning:** The device beeps when target temperature exceeds the alarm threshold.
- **Flashing Alarm:** The flash light flashes when target temperature exceeds the alarm threshold.

Note

If you set rectangle and circle tools to measure temperature, the alarm threshold and linkage method settings only works in the measured areas. Otherwise, the parameters are valid for pixel-to-pixel temperature measurement (whole-screen temperature measurement).

4.6 Calculate Area Size

The device can calculate the size of rectangles and show results on screen.

Steps

1. Select , and go to **Measurement Settings > Area Size Calculation**.
2. Enable **Area Size Calculation**.
3. Draw one or several rectangles on screen.

The rectangles are those you draw for temperature measurement. See ***Measure by Rectangle*** for instructions.

4. In the live view interface, aim a rectangle at the target and press the laser button.

Note

Make sure the lens is parallel to the target when measuring the area size.

Result

The target size is displayed above the rectangle.

4.7 Clear All Measurements

Tap  to clear all set temperature measurement tools.

Chapter 5 Route Inspection

In certain situations that require temperature check for many inspect points, you can use the client software to create inspection routes that cover all the points and send a route inspection task to the device. After the device examines the temperatures of the inspect points, it uploads the results to the client software.

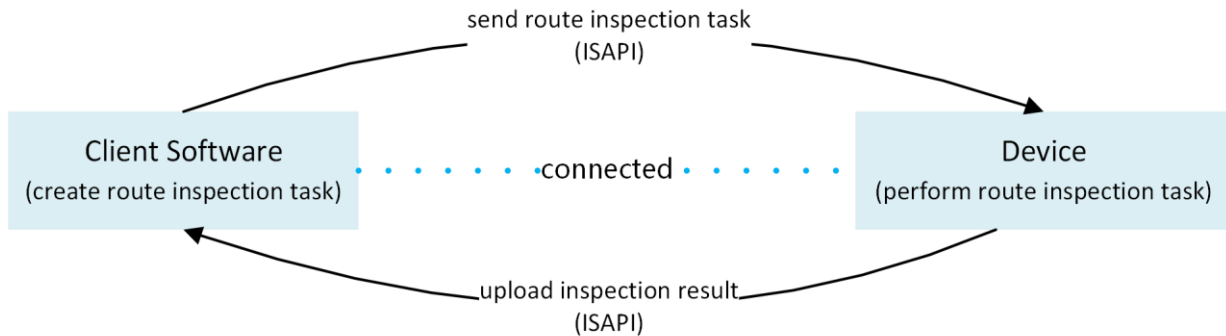

Figure 5-1 Route Inspection Work Flow

The device receives the tasks from and uploads the inspection results to the PC client software by its WLAN or Hotspot function.

5.1 Create Inspection Route and Send Task to Device

Create the inspection routes on the HIKMICRO Inspector. The client should be connected to the device before sending the route inspection task.

Before You Start

- Contact our technical support to get the HIKMICRO Inspector client software. Install the software to your PC.
- The PC should support WLAN function.

Steps

1. Open HIKMICRO Inspector.
2. Create inspect points and routes. See the user manual of HIKMICRO Inspector for instructions.
3. Connect your device and PC to the same LAN. Available methods as below:
 - Connect your PC and your device to the same Wi-Fi network. For device Wi-Fi connection, go to **Settings > Connections > WLAN** to select and connect desired Wi-Fi network. See ***Connect Device to Wi-Fi*** for more instructions.
 - Connect your PC to the device hotspot. Turn on and set up device hotspot by **Settings > Connections > Hotspot**. See ***Set Device Hotspot*** for more instructions.

4. Click **Device Management** to add your device into the client. See the user manual of HIKMICRO Inspector for instructions.
5. Go to **Task Management > Route Management** to select a route and click **Apply to Device**.

What to do next

Check your device to see if the task is successfully received.

5.2 Perform Route Inspection

After receiving inspection tasks from the PC client, you can hold the device and check the inspect points on the route. Upload the results when the inspection is finished.

Before You Start

- Make sure your device has a memory card installed. See **Appearance** for instructions.
- Connect the device to the PC client, and make sure that your device has received inspection tasks from the PC client. See the user manual of HIKMICRO Inspector for instructions of applying inspection task to the device.
- Use HIKMICRO Inspector v1.2.0.100 or newer versions to acquire full product functionality. Otherwise, operations mentioned below may not be available. Contact our technical support to get the software.

Steps

1. Enter inspection mode to start.

Enter the mode by one of the following ways:

- Tap  in the swipe-down menu to enter the inspection route mode.
- Go to **Settings > Device Settings > Inspection Route Mode** to enable the function.



Note

When in the inspection route mode, the device file are not accessible.

2. Press  to enter the inspection task list.
3. Tap to select a task to start.

Note

The font of task in progress is blue on the list.

4. Browse the inspect points and check the inspection requirements for each point.
 - 1) Tap the task to enter the task interface.
 - 2) Press  and  to select an inspect point and check the point details.

Handheld Thermography Camera User Manual



- Before inspecting points, check the point reference images (labeled as No. 4 in figure below) to confirm the image requirements and amount of capturing.
- Check the point parameters (labeled as No. 6 in figure below) to see if the point requires QR code scanning or not. If **Scanning Required** is **Required**, then you should scan the QR code to check in before capturing point images.
- Check diagnostic method of the point (labeled as No. 7 in figure below). If it is an auto-diagnosed point, it shows the diagnostic standard. If it is a manual diagnosed point, it shows diagnosis options.



Figure 5-2 Route Inspection Work Flow



No.	Descriptions
1	Inspection task name.
2	Inspect point list. Press Δ and ∇ to select an inspect point and check the point details.
3	Display inspect point details.
4	Point reference images. They show the parts and angles of targets required for inspection. Capture inspection images as the reference images show. There may be several parts or angles should be inspected. Tap the left and right arrow (labeled as No. 8 in figure above) to browse all reference images.
5	Tap to browse saved inspection captures. Tap the left and right arrow (labeled as No. 8 in figure above) to switch captured images.
6	Tap to check the parameters of the selected point.
7	Check diagnostic information of the point.
8	Tap to switch images.

5. Inspect one point.

- 1) Press  and return to live view.
- 2) Optional: Move to an inspect point and press  to switch to the optical channel.
- 3) Aim the lens to the QR code to scan.
- 4) Press  to capture inspect point images one by one according to the reference images until all required parts and angles of the point are captured.
- 5) After capturing the last required image, mark the diagnosis result.

Note

For auto-diagnosed points, device marks the result according to the predefined diagnosis standards. For points that need manual diagnosis, choose a result option after last capture.

6. After inspection of one point, device switches to the next point automatically. Press  and  to switch points.

7. Repeat above steps to complete inspection and diagnosis of all points.

A completed task has  shown before the task name in the list.

What to do next

- You can delete inspection tasks by selecting a task and tapping .
- Upload the results to the PC client after finishing the route inspection. See the user manual of HIKMICRO Inspector for instructions.

5.3 Upload Inspection Result and View Report

Upload the inspection results to the client software for central management and report generation.

Before You Start

Connect your device with the PC that has the client software installed. See the step of device connection in [***Create Inspection Route and Send Task to Device***](#) for instructions.

Steps

1. Open HIKMICRO Inspector.
2. Click  and **Task Management** and check desired tasks.
3. Click **Read Inspection Result** to download the results from the device.

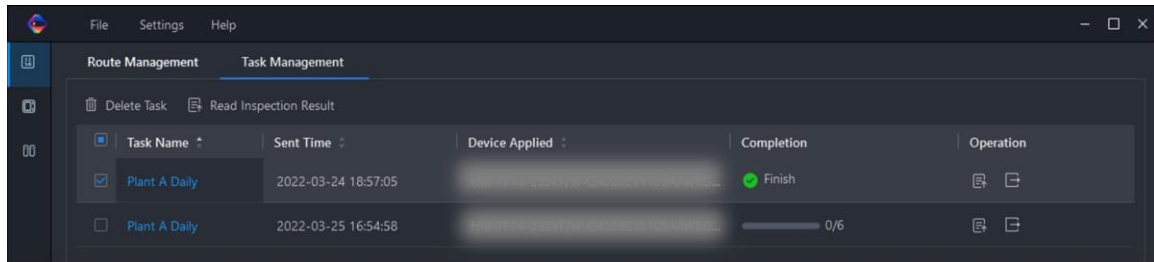

Figure 5-3 Task Management

The task status is shown in **Completion**.

4. Click on a finished task name to show result details.

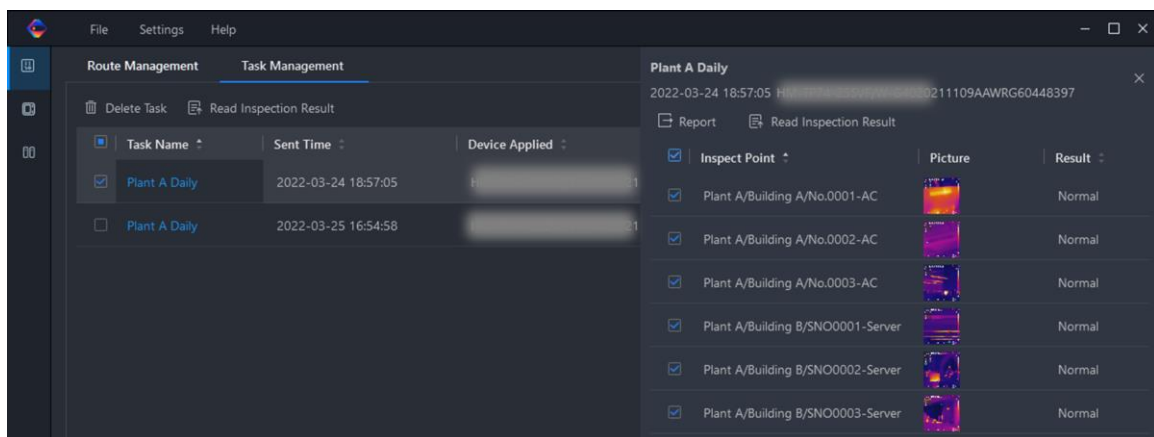

Figure 5-4 Inspection Results

5. Optional: Check a task or the desired inspect points and click **Report** for further analysis and report generation in HIKMICRO Analyzer.

Note

- HIKMICRO Analyzer should be installed in your PC. Download the program from <https://www.hikmicrotech.com/en/industrial-products/hikmicro-analyzer-software/>.
- For the operations instructions in HIKMICRO Analyzer, read the user manual from **Help > User Manual**.
- Please keep HIKMICRO Analyzer up-to-date for the best compatibility and user experience.

Handheld Thermography Camera User Manual

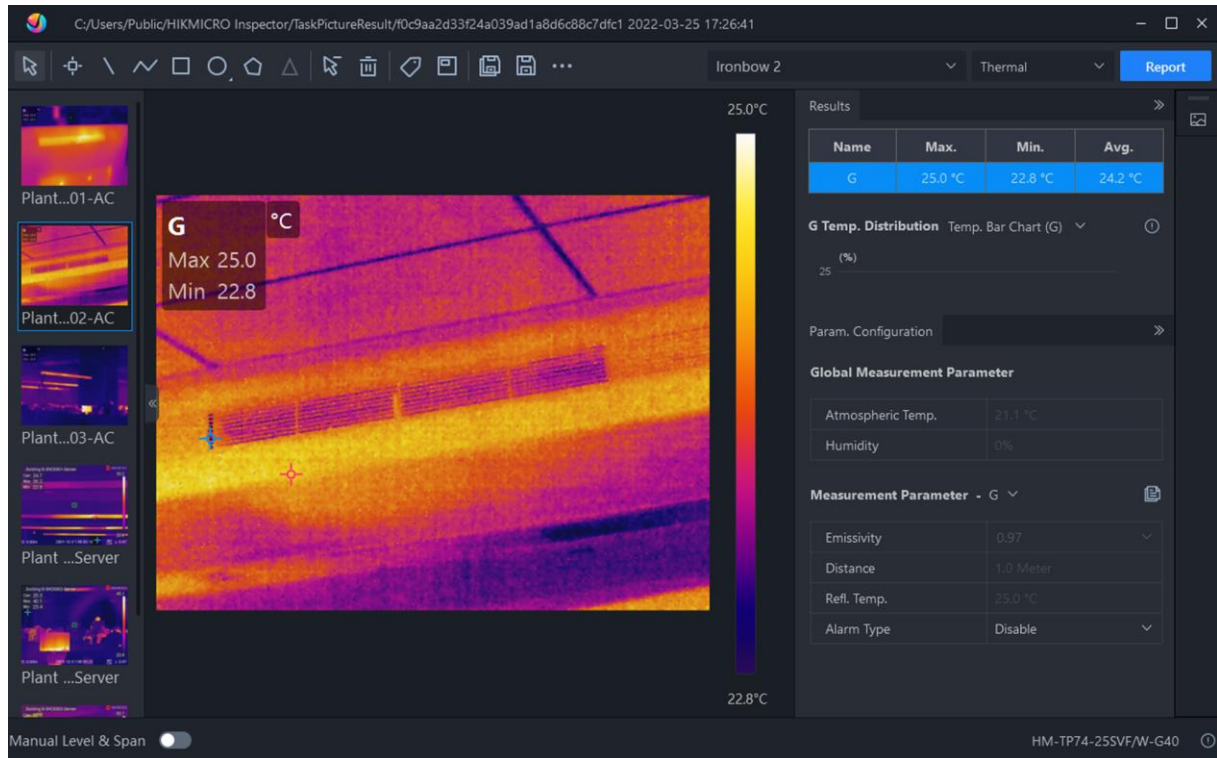

Figure 5-5 Analysis in HIKMICRO Analyzer

Chapter 6 Picture and Video

Insert memory card into the device, then you can record videos, capture snapshots, and mark and save important data.

Note

- Device does not support capturing or recording when the menu is shown.
 - When the device is connected to your PC, it does not support capturing or recording.
 - Go to **Settings > Capture Settings > Filename Header**, you can set the filename header for capturing or recording to distinguish the files recorded in a specify scene.
 - Go to **Settings > Device Settings > Device Initialization** to initialize the memory card as needed.
-

6.1 Capture Picture

Operate the device to capture live images and save the images in local albums.

Before You Start

- Make sure that there is a working memory card mounted in your device. See [*Appearance*](#) to locate the memory card slot of your device.
- Press  in live view interface to enable flashlight in dark environment.

Steps

1. Set a capture mode and press  in live view interface to capture images.

There are 3 modes available. Each mode requires different operations.

- 1) Select , and go to **Capture Settings > Capture Mode**.
- 2) Select a mode.

Capture One Image

Press  once to capture one image.

Continuous Capture

Set the continuous capture amount after select this mode.

Press  in live view, and device captures the set amount of images continuously.

Scheduled Capture

Set the interval for scheduled capture after select this mode.

Press  in live view, and the device captures images according to the set interval.

Press  again or press  to stop capturing.









- 3) Press  to return to the live view interface.
- 4) Aim the lens to your target and press  to capture images.
 - Capture One Image: If **Edit before Saving** is NOT enabled (**Settings > Capture Settings**), the live image freezes and is saved in the default saving album. If **Edit before Saving** is enabled, the device enters the image editing interface.



Figure 6-1 Edit Image

Table 6-1 Editing Options

No.	Description
1	Text Note. 1) Tap to enter the editing page. 2) Tap on screen to input content and press  to save the settings.
2	Voice note. 1) Select voice note and enter voice recording page. 2) Press OK or tap  to start recording. Press OK or tap  again to stop recording. 3) Optional: You can tap to play the recording. If the voice note is unsatisfactory, tap to delete it. Repeat above steps to record again. 4) Press  to exit.
3	Scan QR Code. 1) Select QR code and the device enters the scanning mode. 2) Aim the scanning frame at a QR code. Device reads the code and save the code information.
4	Editing thermal parameters. 1) Modify the image display mode, measurement parameters and tools, palettes, and level & span modes. 2) Optional: If you need a PDF report of the file, tap  on the upper right corner of the screen. Input Report Name and Thermographer , and tap  to generate the report.

 **Note**





Generated reports are saved under the same path of the memory card as the image files. The PDF reports cannot be viewed on local device. Export and read reports on computers. See ***Export Files*** for

No.	Description
	<p>instructions.</p> <hr/> <p>3) When finishing all operations, tap  to save the change and exit the editing interface.</p>
5	After all information added to the image, select Save to exit.

- Continuous Capture/Scheduled Capture: A counter displays in top of the screen showing the completed amount of capturing.

2. Optional: You can set more capture settings as demanded.

Table 6-2 More Optional Capture Settings

Objective	Settings
Save an additional visual image together with the thermal image.	<p>Select , and go to Capture Settings.</p> <p>Enable Save Visual Image and set Visual Image Resolution.</p> <hr/> <p> Note</p> <p>If the targets are in poor light condition, enable Flashlight. The device turns on the flashlight when capturing images.</p> <hr/>
Set the naming rule for images.	<p>The default image naming is filename header + saving time. Filename header is configurable. Saving time is the device system time when the saving occurs.</p> <p>Select , and go to Capture Settings > Filename Header to set filename header.</p>
View clear thermal image on high resolution screen.	<p>Select , and go to Capture Settings.</p> <p>Enable SuperIR before capturing. Resolution of captured images with SuperIR is about 4 times as the original one.</p>

What to do next

- Press  to enter albums to view and manage files and albums. See ***Manage Albums*** and ***Manage Files*** for operation instructions.
- You can connect your device to PC to export local files in albums for further use. See ***Export Files***.
- You can edit the saved images. See ***Edit Images***.

6.2 Record Video

Before You Start

- A memory card should be mounted for video storage.
- Press  in live view interface to enable the flashlight in dark environment if you want to record an optical video.

Steps

1. Select , and go to **Capture Settings > Video Type** to set the video format.
-

Note

Video type configuration is supported by certain models of this series. MP4 video type is adopted for the models of no such configuration option.

Radiometric Video

Raw thermal data is attached in videos of this format. They can only be played and further analyzed with HIKMICRO Analyzer.

Note

When the storage space is smaller than 500 MB, radiometric video recording is not allowed. Accidentally stopped recordings are not saved.

MP4



Recorded videos are saved in .mp4 format. These video clips can be played on local device, and any players that support this format (HIKMICRO Analyzer does not support playing this video format.).

2. **Optional:** Set frame rate for the selected video type.
 - 1) Enable **Frame Rate**.
 - 2) Enter **Video Type** again, and there will be frame rate options appearing under the selected video type.
 - 3) Select **Frame Rate** and scroll to set a desired value.
-

Note

Higher frame rate offers a smoother video with more details for watching especially when motion occurs. But higher frame rate also means bigger video size which consumes more storage space.

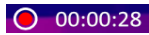
- 4) Press **OK**.
 3. In the live view interface, hold  to start recording. The recording icon and count down number display in the interface.
-

The recording signs for radiometric video and MP4 videos are different. When you see , it is recording a MP4 video. When you see , it is recording a radiometric video.

4. When you finish, hold  again to stop recording. The recording video will be saved automatically and exit.

Note

You can also press **OK** or  to stop recording.

What to do next

Check the saved videos from  in menu mode. See [View and Manage Local Files](#) for more information.

6.3 View and Manage Local Files

Device captured images and videos are saved in local albums. You can create, delete, rename and set an album as the default saving album. For files, operations, such as browsing, moving and deleting, are available.

Steps

















1. Press  to enter **Albums**.
2. To create, rename, delete and set an album as the default saving album, see [Manage Albums](#) for instructions.
3. For file operations, such as, moving or deleting a file, see [Manage Files](#) for instructions.
4. Press  to exit.

Table 6-3 File Type and Description

File Type	Format	Description
MP4 Videos	File Name.mp4	Playing, moving and deleting video files are supported on device.
Radiometric Videos	File Name.rv, or File Name.hrv	File of this format cannot be played on your device. The file extension is determined by the frame rate of a video. Use HIKMICRO Analyzer to play and analyze the file. Please upgrade the software to the latest version, otherwise the .hrv file may not be supported.
Radiometric Images	File Name.jpeg	Editing text and voice notes, moving files, checking basic information, modifying thermal parameters, and deleting files are supported on device.

6.3.1 Manage Albums









You can create several albums to manage captured images and video files on your device. Newly captured images and videos are saved in the **Default Saving Album** .





Task	Operations
Create a New Album	<ol style="list-style-type: none"> 1. Press  to enter Albums. 2. Tap  to add a new album. 3. A soft keyboard is displayed, where you can enter the name of the album by touching the screen. 4. Tap  to finish. <hr/> <p> Note</p> <p>The newly created album becomes the default saving album and appears at the top of the album list.</p> <hr/>
Rename an Album	<ol style="list-style-type: none"> 1. Press  to enter Albums. 2. Select the album to rename. 3. Tap , and select Rename. A soft keyboard is displayed. 4. Tap  to delete the old name, and enter the new name for the album by touching the screen. 5. Tap  to finish.
Change the Default Saving Album	<ol style="list-style-type: none"> 1. Press  to enter Albums. 2. Select the album you want to use as the default saving album. 3. Tap , and select Set as Default Saving Album. <hr/> <p> Note</p> <p>The default saving album appears at the top of the album list.</p> <hr/>
Delete an Album	<ol style="list-style-type: none"> 1. Press  to enter Albums. 2. Select the album you want to delete. 3. Tap , and select Delete. A prompt box appears on the

Task	Operations
	<p>interface.</p> <p>4. Tap OK to delete the album.</p> <hr/> <p> Note</p> <p>The files in an album are deleted as well when deleting the album. Move the files to other albums if they are still needed. See <i>Manage Files</i> for instructions.</p> <hr/>



6.3.2 Manage Files

You can delete the recorded files and move the files to other albums on the device.

Task	Operations
Delete a File	<ol style="list-style-type: none"> 1. Press  to enter Albums. 2. Tap to select the album storing the file to be deleted. 3. In the album, tap to select the file to be deleted. 4. Tap , and select Delete. A prompt box appears on the interface. 5 Tap OK to delete the file.
Delete Multiple Files	<ol style="list-style-type: none"> 1. Press  to enter Albums. 2. Tap to select the album storing the files to be deleted. 3. In the album, tap , and tap the files to be deleted. 4. Tap . A prompt box appears on the interface. 5 Tap OK to delete the files. <hr/> <p> Note</p> <p>You can also delete a single file in this way.</p> <hr/>
Move a File	<ol style="list-style-type: none"> 1. Press  to enter Albums. 2. Tap to select the album storing the file to be moved. 3. In the album, tap to select the file to be moved. 4. Tap , and select Move. The album list is displayed. 5 Tap to select the album to move to.

Task	Operations
Move Multiple Files	<ol style="list-style-type: none"> 1. Press  to enter Albums. 2. Tap to select the album storing the files to be moved. 3. In the album, tap  to select the files to be moved. 4. Tap . The album list is displayed. 5. Tap to select the album to move to. <hr/> <p> Note You can also move a single file in this way.</p> <hr/>

 **Note**

Tap  to select all files, and tap  to cancel the selection.

6.3.3 Edit Images

Editing the text or voice notes saved with the images, and changing the thermal parameters are allowed on your thermal camera.

 **Note**

Image editing function varies within the series. See your actual device for available operation options.

Steps









1. In live view, press  to enter albums.
2. Tap to open an album.
3. Tap to open an image file and tap on the image to call the editing menu.



Figure 6-2 Edit Image

4. Select an option and complete corresponding operations.

No.	Description
1	Editing text note. Add a new text note or change the existed note, and

No.	Description
	press  to save the settings.
2	<p>Editing voice note. You can add a new voice note, play or delete an existed voice note.</p> <ul style="list-style-type: none"> • If the file already has a voice note, tap to play or delete the note. • If the file has no voice note attached, press  or tap .
3	<p>Move the file to other albums.</p> <p>Tap to select a target album for saving the file.</p>
4	Show basic information of the file, example the saving time, resolution of the file.
5	<p>Editing thermal parameters of the image.</p> <ol style="list-style-type: none"> 1) Modify the image display mode, measurement parameters and tools, palettes, and level & span modes. 2) Optional: If you need a PDF report of the file, tap  on the upper right corner of the screen. Input Report Name and Thermographer, and tap  to generate the report. <hr/> <p> Note</p> <p>Generated reports are saved under the same path of the memory card as the image files. The PDF reports can not be viewed on local device. Export and read reports on computers. See <i>Export Files</i> for instructions.</p> <hr/> <ol style="list-style-type: none"> 3) When finishing all operations, tap  to save the change and exit the editing interface.
6	Delete the file.

6.4 Export Files

Connect the device to your PC with supplied cable, you can export the recorded videos, captured snapshots, and PDF reports.

Note

Cast screen should be turned off before exporting files, or the PC cannot detect the disk. Go to **Settings > Connections > USB Cast Screen** to check the function status.

Steps

1. Open the cover of cable interface.
2. Connect the device to your PC with cable and open the detected disk.
3. Select and copy the videos or snapshots to PC to view the files.
4. Disconnect the device from your PC.

Note

For the first time connection, the driver will be installed automatically.

What to do next

You can import the captured snapshots to HIKMICRO Analyzer for further data analysis. See the *User Manual of HIKMICRO Analyzer* for the operation guide.



Chapter 7 Distance Detection

The laser range finder consists of a laser transmitter and a laser receiver. The device detects the distance to a target by measuring the time it takes for a laser pulse to reach the target and return to the laser receiver. This time is converted to a distance, which is displayed on the screen.

Before You Start

- It is recommended to use this function in non-glare environment, such as indoor environment.
- It is recommended that the target has good light reflection, such as white paper and cable.

Steps

1. Select , and go to **Device Settings > Display Settings**.
2. Enable **Distance**.
3. Press  to save and exit.
4. In the live view interface, aim the cursor at the target and hold the laser button.
5. Release the laser button to finish distance measurement.



Result

The distance displays on the left status bar of screen.

Chapter 8 Geographic Location Display

Equipped with satellite positioning modules, the device is able to display its longitude and latitude on the live image and in the captured images.

Steps

1. Select , and go to **Device Settings > GPS**.
2. Tap  to enable the GPS function. The device will prompt the GPS positioning result.

Result

You can see the location displayed at the left status bar of the screen.

Note

- The satellite module is not able to receive signals when the device is indoor. Place the device in an empty outdoor space to receive signals.
 - In an outdoor space, wait for a moment for the device to display its location.
 - The location information is also attached in captured radiometric images. You can read the location by HIKMICRO Analyzer.
 - Location display is only supported by models with satellite positioning modules.
-

Chapter 9 Direction Display

Equipped with a compass, the device is able to display its direction on the live image and in the captured images.

Note

The function is supported by certain models.

Select , and go to **Device Settings > Compass** to enable the compass modules, then follow the pop-up instructions to calibrate the compass. See [*Calibrate Compass*](#) for more information.

After successful calibration, you can see the direction displayed at lower right corner of the screen. It is recommended to read the direction when you lay the device horizontally. To increase the direction accuracy, you can set the magnetic declination correction. See [*Magnetic Declination Correction*](#) for instructions.

Note



The direction information is also attached in captured radiometric images. You can read the direction by HIKMICRO Analyzer.

9.1 Calibrate Compass

Compass calibration is a must for correction direction display.

You need to calibrate the compass when you enable the function for the first time.

Steps

1. Call the calibration guide by the following ways.
 - Select , and go to **Device Settings > Compass** to turn the function off and on again.
 - Tap  in the swipe-down menu to quickly turn on/off the compass.
2. When you enable compass for the first time, or the compass is magnetically interfered, compass calibration guide pops up. Follow the screen instructions to move and rotate the device.

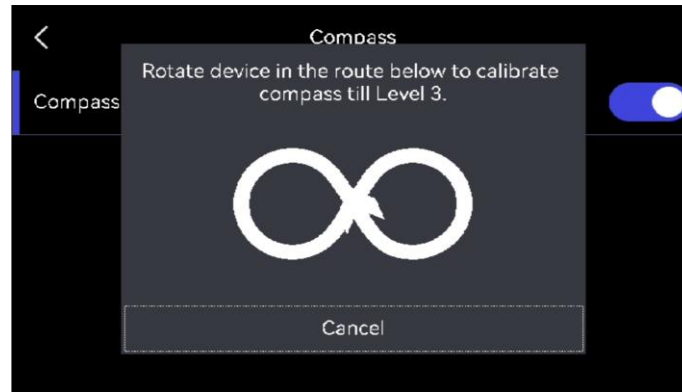



Figure 9-1 Calibrate Compass

Note

- During calibration, keep moving and rotating the device to make sure that the device faces every possible directions.
- **Calibration Level** indicates the validity of calibration, higher level means more accurate compass reading. Calibration succeeds when the status bar in the live view interface shows, and **Calibrated Level** turns to 3.

3. Stop rotating the device when calibration success message pops up.

Result

The status bar in the live view interface shows  after successful calibration. If the number in this icon is smaller than 3, it means that the compass is not properly calibrated and the direction displayed might not be correct.

9.2 Magnetic Declination Correction

Magnetic declination is the angle variation between magnetic north and true north. Adding the magnetic declination to the compass increase the accuracy of direction reading.



Go to **Local Settings > Device Settings > Compass > Magnetic Declination Correction** to add the declination of device location.

Chapter 10 Device Connections

10.1 Connect Bluetooth

You can record and hear the sound contained in the videos or images via Bluetooth headsets after pairing the device with Bluetooth headsets successfully.

Steps

1. Select , and go to **Connections > Bluetooth**.
2. Tap  to enable the Bluetooth.

Note

You can also press  or **OK** to quit pairing.

The device will search the nearby enabled Bluetooth headsets and pair them automatically.



Result

After pairing you can record and hear the sound via the headsets while recording and playing the video or image.

10.2 Cast Device Screen to PC

The device supports casting screen to PC by UVC protocol-based client software or player. You can connect the device to your PC via a type-C cable, and cast the real-time live view of the device to your PC.

Steps

1. Select , and go to **Connections > USB Cast Screen** to turn on the function on device.
Or tap  in the swipe-down menu to turn on/off **USB Cast Screen**.
2. Open the UVC protocol-based client software on your PC.
3. Use a type-C cable to connect your device with PC.



What to do next

For more instructions about how to cast the screen, please visit our website:

<https://www.hikmicrotech.com>.

10.3 Connect Device to Wi-Fi

Steps

1. Select , and go to **Connections > WLAN**.
2. Tap  to enable Wi-Fi, and the searched Wi-Fi will be listed.

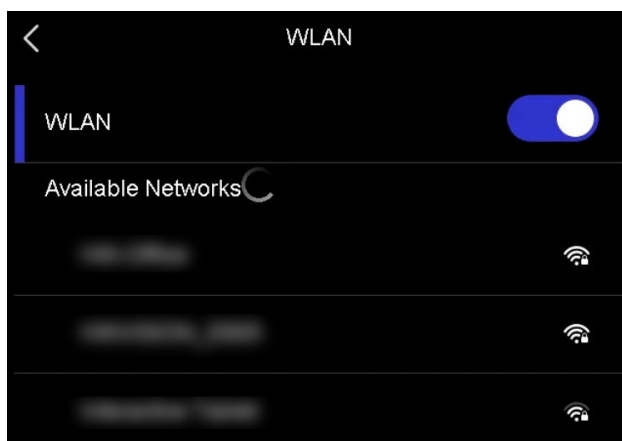



Figure 10-1 Wi-Fi List

3. Select Wi-Fi to connect to and a soft keyboard is displayed.
4. Enter the password.
5. Tap  to hide the keypad and connect Wi-Fi.

Note

- DO NOT tap **space**, or the password may be incorrect.
 - Leaving the Wi-Fi setting interface does not interrupt the connection.
-

Result

A Wi-Fi icon shows on the main interface when the connection is completed.

10.4 Set Device Hotspot

With the device hotspot, other equipment with Wi-Fi function can join the device for data transmission.

Steps

1. Select , and go to **Connections > Hotspot**.

2. Tap  to enable hotspot function.
3. Set and join the hotspot.

Using hotspot password

- a. Tap **Set Hotspot**. A soft keyboard is displayed.
- b. Set the password for the hotspot by tapping the screen.
- c. Tap  to finish.
- d. Enable the Wi-Fi function of other equipment and search the device hotspot to join.

Using hotspot QR code

- a. Tap **QR Code**. A QR code is displayed.
- b. Scan the QR code with HIKMICRO Viewer to join the hotspot.

Note

- When setting the password, do not tap **space**, or the password may be incorrect.
 - The password should be at least 8 digits, consisting of numbers and characters.
 - Please tap  to enter password into the password field.
-

4. Tap  to save.

Chapter 11 Thermal View Mobile Client Connection

The device supports both Wi-Fi connection and hotspot. Connect the device to HIKMICRO Viewer, and you can control the device via mobile client.

11.1 Connect via Wi-Fi

Before You Start

Download and install HIKMICRO Viewer on your phone.

Steps

1. Connect your device to a Wi-Fi network. See [***Connect Device to Wi-Fi***](#) for instructions.
2. Connect your phone to the Wi-Fi network that the device is in.
3. Launch the app and follow the startup wizard to create, and register an account.
4. Search and add the device to the mobile client.

Result

You can view the live view, capture snapshots, and record videos via the client.

11.2 Connect via Hotspot

Before You Start

Download and install HIKMICRO Viewer on your phone.

Steps



1. Turn on the device hop spot and complete hot spot settings. See [***Set Device Hotspot***](#) for instructions.
2. Connect your phone to the hotspot of the device.
3. Launch the app and follow the startup wizard to create, and register an account.
4. Search and add the device to the mobile client.

Result

You can view the live view, capture snapshots, and record videos via the client.

Chapter 12 System Settings

12.1 Set LED Light

In live view mode, press  to enable/disable the LED light. Or tap  on the swipe-down menu.

12.2 Set Unit

Select , and go to **Device Settings** > **Unit** to set the temperature unit and distance unit.

12.3 HDMI Image Output

You can view the image on the display unit for details with this function.



If your device has a micro HDMI output interface, connect the device and a display unit to cast the image.

Note

This function is only supported by the models with micro HDMI output interface.

12.4 Set Time and Date

Steps

1. Select , and go to **Local Settings** > **Device Settings** > **Time and Date**.
2. Set the date and time.
3. Press  to save and exit.

Note

Go to **Display Settings** to enable or disable time and date display.

Chapter 13 Maintenance

13.1 View Device Information

Select , and go to **Local Settings > Device Settings > Device Information** to view the device information.

13.2 Upgrade Device

Before You Start

- Please download the upgrade file from the official website <http://www.hikmicrotech.com> or contact the custom service and technical support to get the upgrade file first.
- Make sure that the device battery is fully charged.
- Make sure that Auto Power-off function is turned-off to avoid accidental suspension during upgrading.
- Make sure that a memory card has been installed to device.

Steps

1. Connect the device to your PC with cable and open the detected disk.
2. Copy the upgrade file and paste it to the root directory of the device.
3. Disconnect the device from your PC.
4. Reboot the device and then it will upgrade automatically. The upgrading process will be displayed in the main interface.

Note

After upgrading, the device reboots automatically. You can view the current version in **Device Settings > Device Information**.

13.3 Restore Device

Select , and go to **Device Settings > Device Initialization > Restore Device** to initialize the device and restore default settings.

13.4 Initialize Memory Card

When a memory card is use on the handheld thermal camera for the first time, it needs to be initialized first.

Select , and go to **Device Settings > Device Initialization> Format Storage Card** to initialize the memory card.

Caution

If there are files in the memory card, make sure that the files has been backed up before memory card initialization. Once the card is initialized, data and files cannot be recovered.

13.5 About Calibration

We recommend you send the device back for calibration once a year, and please contact the local dealer for the information on maintenance points. For more detailed calibration services, please refer to <https://www.hikmicrotech.com/en/support/calibration-service/>.

Chapter 14 Appendix

14.1 Common Material Emissivity Reference

Material	Emissivity
Human Skin	0.98
Printed Circuit Board	0.91
Concrete	0.95
Ceramic	0.92
Rubber	0.95
Paint	0.93
Wood	0.85
Pitch	0.96
Brick	0.95
Sand	0.90
Soil	0.92
Cloth	0.98
Hard Paperboard	0.90
White Paper	0.90
Water	0.96

14.2 FAQ

Scan the following QR code to get device common FAQ.





HIKMICRO

See the World in a New Way

Facebook: HIKMICRO Thermography

Instagram: hikmicro_thermography

E-mail: support@hikmicrotech.com

LinkedIn: HIKMICRO

YouTube: HIKMICRO Thermography

Website: <https://www.hikmicrotech.com>

UD34027B-A