



# HM-L129IR

## IR Torch Pro

IR Torch is applied to optical products, such as handheld thermal camera and digital night vision scope. It uses infrared light as supplementary light to improve image quality.

### Key Features

- IR Wavelength: 940 nm

### Specification

POWER SUPPLY	
POWER	By battery
BATTERY TYPE	HIKMICRO HM-3632DC or HM-3633DC (not included)
BATTERY OPERATING TIME	Up to 5.5 h
CAPACITY	3350 mAh
GENERAL	
OPERATING TEMPERATURE RANGE	-20°C to 50°C (-4°F to 122°F)
WEIGHT	150 g (0.33 lb)(without battery)
BODY MATERIAL	Metal
DIMENSION	151.11 mm × 38.2 mm (5.95" × 1.5")
POWER INPUT	3.6 V
INFRARED ILLUMINATOR	
IR OPTICAL POWER	Up to 700 mW
IR WAVELENGTH	940 nm
IRRADIATION DISTANCE	Up to 200 m
BEAM ANGLE	6° to 35°
EMITTER	LED

## Available Model

**HM-L129IR**

## Dimension

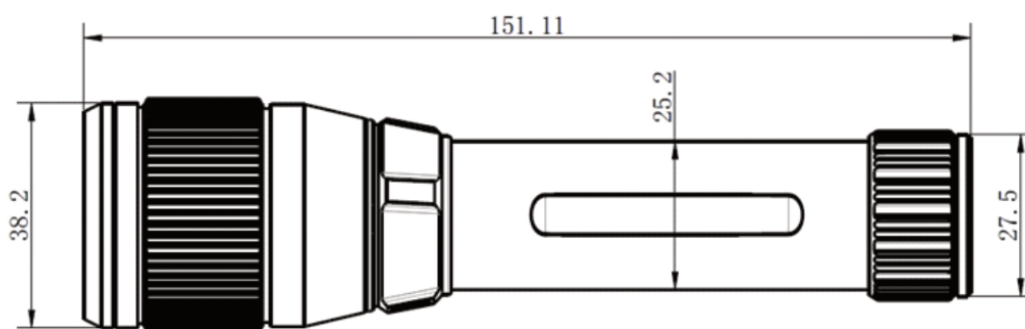

Unit: mm

COMPLIANCE NOTICE: The thermal series products might be subject to export controls in various countries or regions, including without limitation, the United States, European Union, United Kingdom and/or other member countries of the Wassenaar Arrangement. Please consult your professional legal or compliance expert or local government authorities for any necessary export license requirements if you intend to transfer, export, re-export the thermal series products between different countries.



 HIKMICRO Outdoor  hikmicro\_outdoor  HIKMICRO Outdoor  HIKMICRO  [info@hikmicrotech.com](mailto:info@hikmicrotech.com)  <http://hikmicrotech.com/en>

room 313, unit B, building 2, 399 danfeng road, xixing subdistrict, binjiang district, hangzhou, zhejiang  
@hangzhou microimage software co., Ltd .2020 | data subject to change without notice!