

## HM-TR13-35XF/W-TH35 Thermal Image Scope



HIKMICRO HM-TR13-35XF/W-TH35 Thermal Image Scope has 384 × 288 thermal detector and 1024 × 768 OLED monitor, which provides clear image under harsh environment conditions like darkness, fog, smoke, dust, rain, snow, wood, camouflage, etc. The device is used as a handheld monocular, clip on scope, or thermal image scope. The scope is mainly applied to scenarios such as patrolling, and hunting, etc.

### Key Features

- 384 × 288 thermal resolution, high sensitivity detector, NETD less than 35 mk (25 °C, F#=1.0)
- Image processing technology: Adaptive AGC, DDE, 3D DNR
- 1024 × 768 resolution 0.39-inch OLED display
- Supports distance measurement, and hotspot function
- Supports video recording and snapshot, built-in EMMC (16 GB)
- Supports digital zoom and cursor function, palettes of color adjustable
- Up to 4.5 hours continuous working

## Specification

<b>Thermal Module</b>	
Image Sensor	Uncooled Focal Plane Arrays
Pixel Interval	17 $\mu$ m
Max. Resolution	384 $\times$ 288
Response Waveband	8 $\mu$ m to 14 $\mu$ m
NETD	$\leq$ 35 mk (25 $^{\circ}$ C, F#=1.0)
Lens (Focal Length)	35 mm
IFOV	0.49 mrad
Field of View	10.0 $^{\circ}$ $\times$ 8 $^{\circ}$
F Number	F1.0
Frame Rate	50 Hz
Magnification	2.14X
<b>Image Display</b>	
Monitor	0.39-inch, OLED, 1024 $\times$ 768
Palettes	Black hot, white hot, red hot, fusion
Exit Pupil	6 mm
Eye Relief	45 mm
Observation Distance	Max. 1235 m
Contrast Adjustment	Yes
Brightness Adjustment	Yes
<b>System</b>	
Digital Zoom	1X, 2X, 4X, 8X
Cursor	Yes
Hotspot	Yes
Distance Measurement	Yes
Scene Mode	Jungle, Recognition
Standby mode	Yes
Video Recording	Yes
Picture Snapshot	Yes
DPC	Yes
PIP	Yes
Uniformity Correction	Auto, Manual, External Correction
Storage	Built-in EMMC (16 GB)
<b>Power Supply</b>	
Battery	Replaceable Applicable type: CR123A, RCR123A
Battery Operating Time	4.5 h (25 $^{\circ}$ C, with hotspot off) 4 h (25 $^{\circ}$ C, with hotspot on)
Anti-reverse battery connection	Yes

Overvoltage Protection	Yes
Battery Capacity Display	Yes
Type-C Power Supply	5 VDC, 2 A Supports external power supply
<b>General</b>	
Port	Type-C
Working Temperature	-20 °C to 55 °C (-4 °F to 131°F)
Protection Level	IPX7
Vibration & Shock	750 g/1 ms
Dimension (L × W × H)	186.6 mm × 59.4 mm × 67.1 mm
Weight	0.415 kg (0.91 lb) without eyepiece and batteries

## Available Model

HM-TR13-35XF/W-TH35

## Accessory

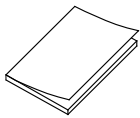

Quick Start Guide  
(×1)



Battery CR123A (×2)

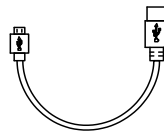

Type-C Cable (×1)

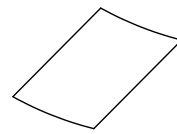

Dust-free Cloth  
(×1)



Eyepiece of Scope  
(×1)



Tightening Plate  
(×1)



Bag (×1)

## Optional

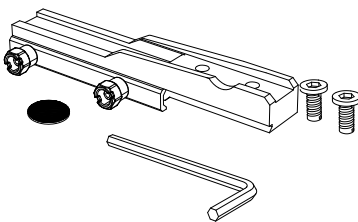

Rail System  
Rail (×1)  
Tightening Plate (×1)  
Screws (×2)  
Wrench (×1)

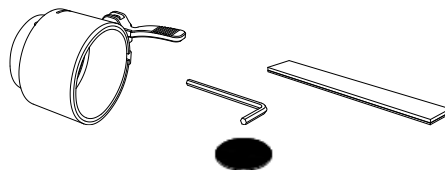

Clip-on System  
Adapter (×1)  
Wrench (×1)  
Insert Ring (×5)  
Tightening Plate (×1)

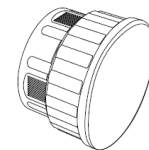

Eye piece of Clip-On  
(×1)

## Dimension

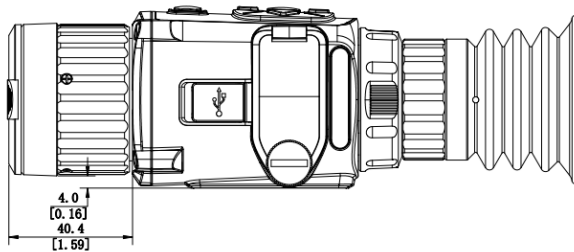
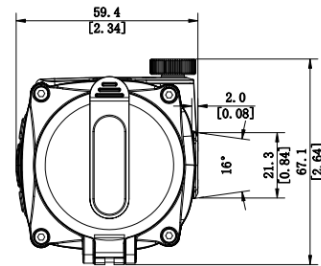
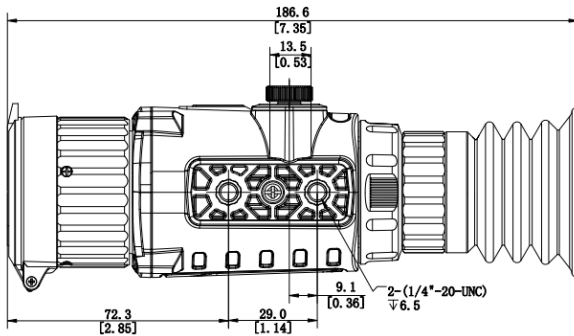

Unit:mm[Inch]

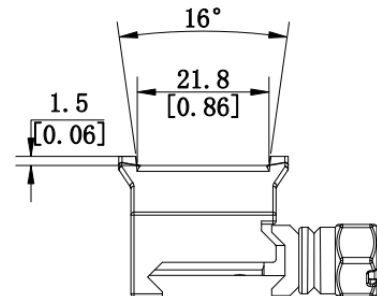
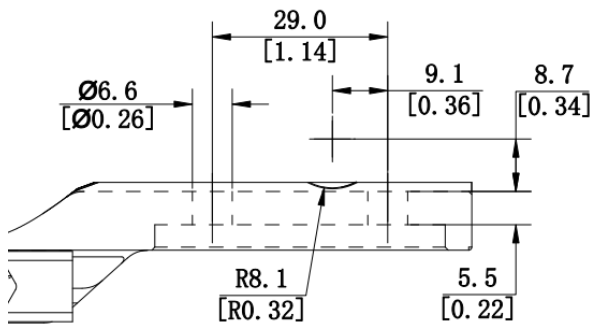

Unit:mm[Inch]

COMPLIANCE NOTICE: The thermal series products might be subject to export controls in various countries or regions, including without limitation, the United States, European Union, United Kingdom and/or other member countries of the Wassenaar Arrangement. Please consult your professional legal or compliance expert or local government authorities for any necessary export license requirements if you intend to transfer, export, re-export the thermal series products between different countries.

