

G31 Handheld Thermal Camera



The HIKMICRO G31 high-performance handheld thermal camera is ideal for industrial, predictive, oil and gas, and utility maintenance inspections.

HIKMICRO G31 has a high sensitivity (NETD < 35 mK) and high resolution (384 x 288) HIKMICRO VOx detector, and the temperature calibration is up to 650°C. Advanced features help thermal imaging professionals to easily survey equipment and find signs of malfunction, such as GPS and compass annotations, continuous digital zoom, and 1-Tap level and span.

Connect HIKMICRO Viewer App or HIKMICRO Analyzer software to transfer, analyze, and share pictures, and generate reports for free.

▪ Features

- Thermal resolution: 384 x 288 (110,592 pixels), NETD : < 35 mK (@ 30 °C, F#=1.0)
- Temperature measurement range : -20 °C to 650 °C (-4 °F to 1202 °F)
- 1.x to 8.x continuous digital zoom
- Manual, automatic, and 1-Tap Level and Span
- GPS & compass annotation functions
- Long-distance laser light supplement for thermography targets
- LED light supplement provides light in dark scenarios

▪ Specification

Infrared Image	
IR Resolution	384 x 288 (110,592 pixels)
SuperIR	768 x 576 (442,368 pixels)
NETD	< 35 mK (@ 30 °C, F#=1.0)
Image Frequency	50 Hz
Detector Pitch	17 μm
Spectral Range	7.5 to 14 μm
Focal Length	15 mm For other optional lenses, see the respective spec sheets.
F-number	F 1.0
Field of View (FOV)	25° × 19° For other optional lenses, see the respective spec sheets.
Spatial Resolution (IFOV)	1.13 mrad For other optional lenses, see the respective spec sheets.
Min. Focus Distance	0.1 m (0.33 ft) For other optional lenses, see the respective spec sheets.
Focus Mode	Laser Assisted AF/Continuous AF/AF/Manual Focus/Touch AF
Focus Speed	Approx. 2 second
Image Display	
Visual Camera	3264 × 2448 (8 MP)
Display	800 × 480 Resolution, 4.3" LCD Touch Screen
Screen Brightness	Manual/Auto
Digital Zoom	1.x to 8.x continuous
Color Palettes	White Hot, Black Hot, Rainbow, Ironbow, Red Hot, Fusion, Rain, Blue Red, Blue Yellow, Bright Rainbow
Focus Mode Palette	Above/Below/Interval
Color Alarm	Above/Below/Interval/Insulation/Condensation
Image Modes	Infrared/Visual/Fusion/PIP/Blending
Measurement and Analysis	
Object Temperature Range	Range -20°C to 150°C (-4 °F to 302°F) Range 0°C to 650°C (32°F to 1202°F)
Accuracy	Range -20 to 150°C (-4 to 302°F): -20 to 0°C (-4 to 32°F): ±2°C (±3.6°F) 0 to 100°C (32 to 212°F): ±1°C (±1.8°F) 100 to 150°C (212 to 302°F): ±1% Range 0 to 650°C (32 to 1202°F): 0 to 100°C (32 to 212°F): ±2°C (±3.6°F) 100 to 650°C (212 to 302°F): ±2%
Measurement Tools	Center Spot, Hot Spot, Cold Spot User-definable: Delta T, 10 spots, 1 line, 5 rectangles, and 5 circle

Level and Span Mode	Auto/Manual/1-Tap Touch-screen
Inspection Route	Yes
Data Storage and Communication	
Storage Media	Removable 64 GB Micro SD Card
Image Storage Capacity	Approx. 60,000 Images
Annotations	Voice note: max. 60 seconds; Text note: max. 200 characters
Video Storage Capacity	Approx. 54 hours
Video File Format	MP4 video and radiometric video
Image Format	Radiometric JPEG
Radiometric Infrared-Video Streaming (Compressed)	Over UVC, Wi-Fi
General	
Wi-Fi	802.11 b/g/n (2.4 GHz and 5 GHz)
Bluetooth	Bluetooth 4.2
USB Interface	USB Type-C
HDMI Interface	Yes
LED Light	Yes
Laser Pointer	Yes
Laser	Yes, Class II, Wavelength: 635 nm; Power: < 1 mW
Battery Type	Interchangeable and rechargeable Li-ion battery
Laser Distance Meter	Indoor distance: 50 m (164 ft); Outdoor distance: 10 m (33 ft).
GPS & Compass	Yes
Battery Operating Time	Approx. 4 hours
Battery Charging Time	Approx. 4 hours fully charged
Power Saving Mode	Yes
Protection Level	IP54, IEC 60529
Drop Test Height	2 m (6.56 ft), IEC 60068-2-31
Safety	IEC 61010-1
EMC	EN 301 489-1, EN 301 489-17, EN IEC 61000-6-2, EN IEC 61000-6-3, EN IEC 61326-1, EN IEC 61326-2-2
Vibration	2 g, IEC 60068-2-6
Shock	25 g, IEC 60068-2-27
Storage Temperature Range	-20°C to 60°C (-4°F to 140°F)
Working Temperature Range	-20°C to 50°C (-4°F to 122°F)
Relative Humidity	< 95% non-condensing
Weight	Approx. 1058 g (2.33 lb)
Dimension	284.7 × 120.6 × 124.5 mm (11.21 × 4.75 × 4.9 in)
Tripod Mounting	UNC ¼" -20
Warranty	3 years for the full product, 10 years for the detector, and 2 years for the battery.

- **Available Model**
HM-TP73-15SVF/W-G31
- **Dimension**

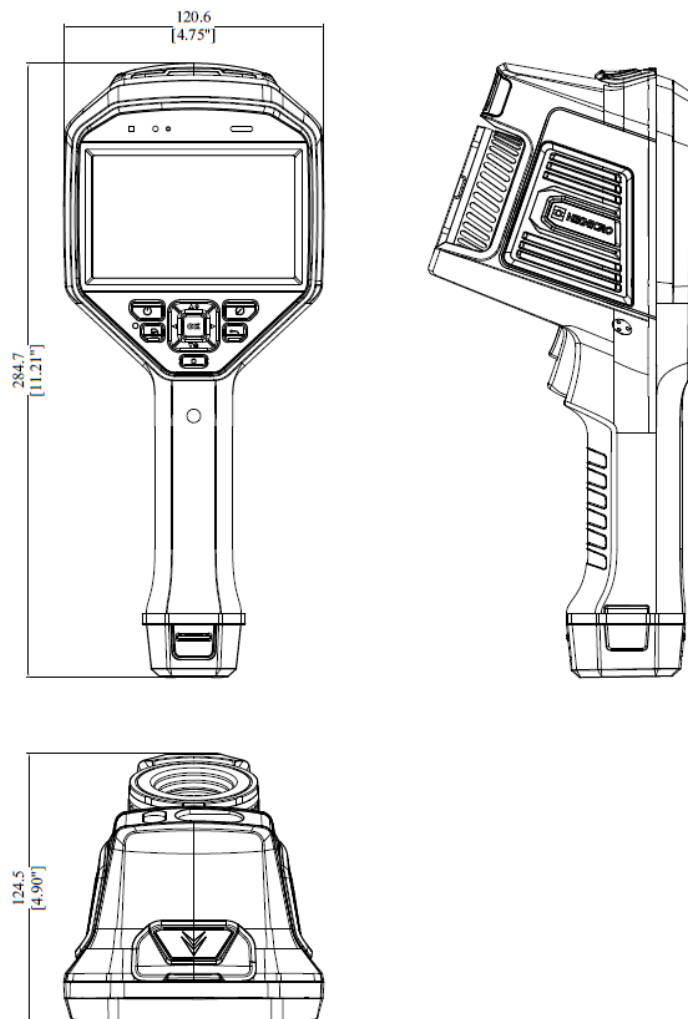

- **Packaging List**

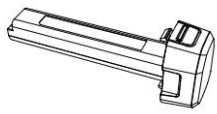

Battery (x3)

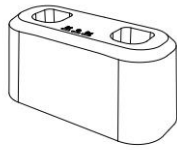

Charging Base (x1)

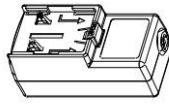

Power Adapter (x1)

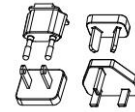

Adapter (x4)

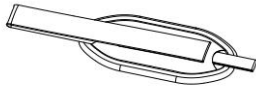

Hand Strap (x1)



USB Cable (x1)



HDMI Cable (x1)



SD Card (x1)



Lens cover (X1)



Accessories bag (x1)



Quick Start Guide (x1)

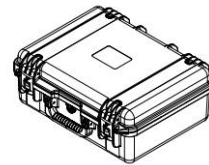

Carrying Case (x1)

▪ Accessory

▪ Optional

INR18650-35E-1S2P
G Series Battery



HM-G320-LENS1
2x telephoto lens, for
G31



HM-5202ZC2
G Series Charging
Base



HM-G330-LENS1
3x telephoto lens, for
G31



HM-701ZJ-G01-
SHIELD
Handheld
Thermography
Accessory



HM-SP01-POUCH
M/G/SP Series Pouch



HM-G305-LENS1
0.5x wide angle lens,
for G31



COMPLIANCE NOTICE: The thermal series products might be subject to export controls in various countries or regions, including without limitation, the United States, European Union, United Kingdom and/or other member countries of the Wassenaar Arrangement. Please consult your professional legal or compliance expert or local government authorities for any necessary export license requirements if you intend to transfer, export, re-export the

thermal series products between different countries.



 Hikmicro Industrial

 hikmicro_industrial

 HIKMICRO Industrial

 HIKMICRO

 info@hikmicrotech.com

 www.hikmicrotech.com

© Hangzhou Microimage Software Co., Ltd. All Rights Reserved.

*Note: Specifications are subject to change without notice. For the current specs,
please go to www.hikmicrotech.com