

User Manual

Thermal Monocular

THUNDER 3.0 SERIES

V5.5.100 202412



Contact Us

CONTENTS

1	Overview	1
1.1	Device Description.....	1
1.2	Main Function.....	1
1.3	Appearance.....	2
2	Preparation	5
2.1	Install Battery.....	5
2.1.1	Battery Instruction	5
2.1.2	Change Battery.....	5
2.2	Connect Device.....	6
2.3	Install Monocular Eyepiece.....	7
2.4	Install Adapter	8
2.5	Remove Adapter	9
2.6	Install Daylight Scope.....	9
2.7	Power On/Off.....	10
2.8	Auto Screen Off	11
2.9	Menu Description	11
2.10	App Connection	12
2.11	Firmware Status	13
2.11.1	Check Firmware Status.....	13
2.11.2	Upgrade Device	14
2.12	Calibrate Image (Overview)	15
2.13	Reference Line (Overview).....	16
3	Image Settings	17
3.1	Adjust Focus.....	17
3.2	Adjust Brightness	17
3.3	Adjust Contrast.....	18
3.4	Adjust Tone.....	18
3.5	Adjust Sharpness	19
3.6	Select Scene Mode.....	20
3.7	Set Palettes.....	20
3.7.1	Custom Enabled Palettes.....	20
3.7.2	Switch Palettes	21
3.8	Switch Eyepiece Type	24
3.9	Adjust Digital Zoom.....	24
3.10	Set Picture in Picture Mode.....	25
3.11	Zoom Pro	26
3.12	Flat Field Correction.....	26
3.13	Correct Defective Pixel.....	27
3.14	Calibrate Image	27
3.15	Reference Line.....	29
4	Measure Distance (LRF Model).....	31

Thermal Monocular User Manual

5	General Settings	33
5.1	Set OSD	33
5.2	Set Brand Logo	33
5.3	Burning Prevention	33
5.4	Capture and Video.....	34
5.4.1	Capture Picture	34
5.4.2	Set Audio	34
5.4.3	Record Video.....	34
5.4.4	Prerecord Video	35
5.4.5	Local Album	35
5.5	Export Files	36
5.5.1	Export Files via HIKMICRO Sight.....	36
5.5.2	Export Files via PC	37
6	System Settings	39
6.1	Adjust Date	39
6.2	Adjust Time.....	39
6.3	Set Language.....	39
6.4	Set Unit.....	40
6.5	Video Output (Analog).....	40
6.6	Video Output (Digital).....	41
6.7	View Device Information	41
6.8	Restore Device.....	41
7	Frequently Asked Questions	42
7.1	Why is the monitor off?.....	42
7.2	Capturing or recording fails. What's the problem?.....	42
7.3	Why the PC cannot identify the device?.....	42

1 Overview

1.1 Device Description

HIKMICRO THUNDER 3.0 Thermal Monocular features higher thermal sensitivity, delivering stunning image clarity. The latest HIKMICRO Shutterless Image System (HSIS) ensures a super smooth visual experience, while the enhanced ISP algorithm provides unparalleled detail. Additionally, the compact LRF module in lens design integrates a Laser Range Finder (LRF) module in the objective lens (available on LRF model) for added convenience.

1.2 Main Function

- **Zoom Pro:** Available in monocular mode. With Zoom Pro, the details of zoomed live view image will be enhanced.
- **HSIS (HIKMICRO Shutterless Image System):** It is a dynamic learning process without image quality loss. This eliminates the need for periodic calibration pauses, ensuring you never miss a critical moment in the field.
- **Local Album:** Local album stores captured images and recoil-activated videos, which help you clarify whether you get the game immediately.
- **Distance Measurement:** Available on LRF model. The device can measure the distance between the target and observation position.
- **Recoil-activated Video with Audio:** the device can automatically start recording before the recoil-activation and end recording after the recoil-activation.
- **Calibrate Image:** You can adjust and save the position of the image window for different users.
- **Auto Screen Off:** The function allows the device to enter standby mode/wake up through angle changes. The function darkens the screen to save energy and extend battery life.
- **App Connection:** The device can capture snapshots, record videos, and set parameters by HIKMICRO Sight app after being connected to your phone via hotspot.

1.3 Appearance

The appearance may vary according to different models. Please take the actual product for reference.

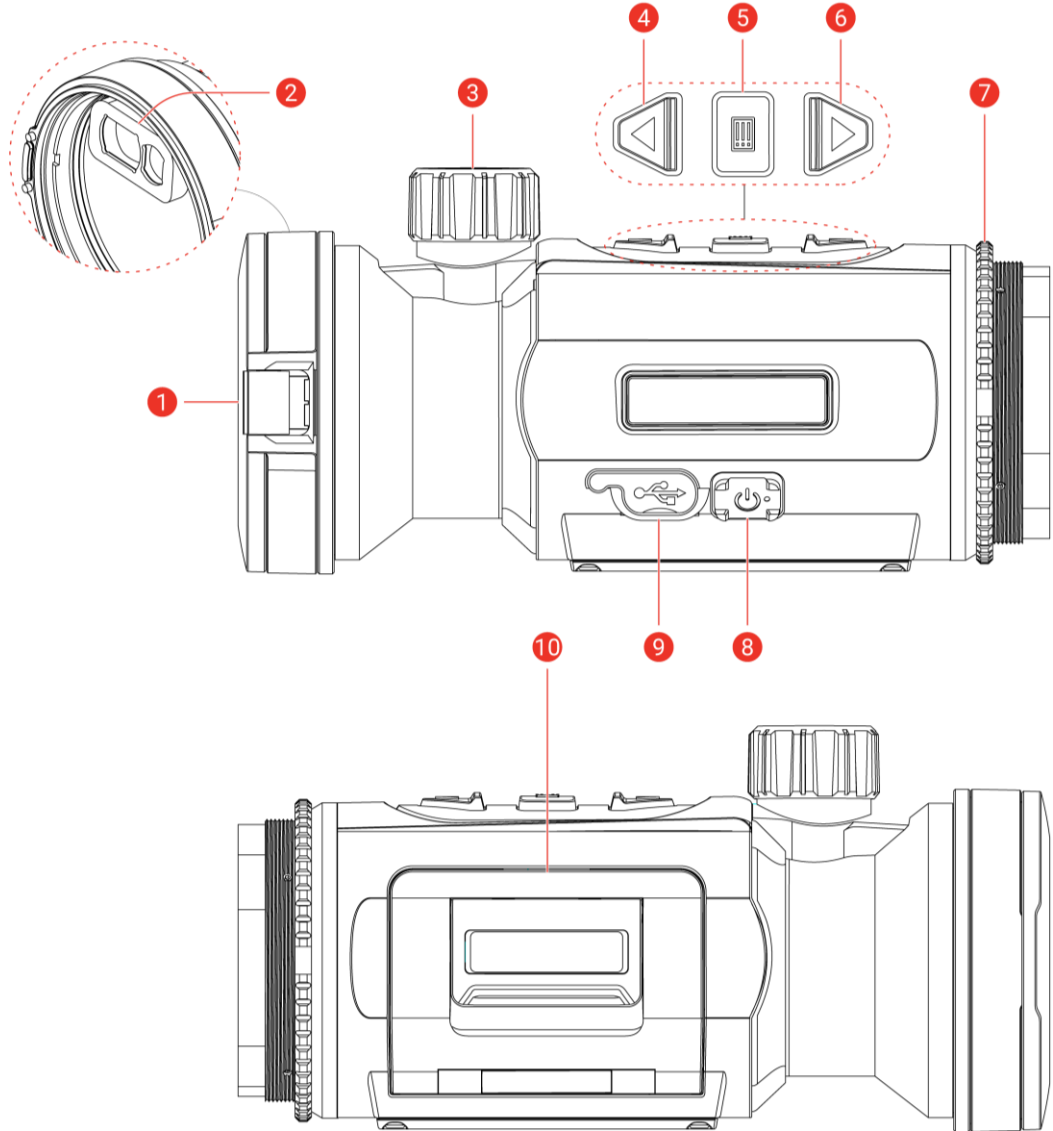



Figure 1-1 Appearance

Table 1-1 Component Descriptions

No.	Component	Description
1	Lens Cover	Protects the lens.
2	Laser Range Finder (LRF Model)	LRF module in the lens. Measures the distance to the target with laser.
3	Focus Knob	Adjusts focus to obtain clear targets.
4	△ Up Key	Non-Menu Mode: ● Press: Capture snapshots.

Thermal Monocular User Manual

No.	Component	Description
		<ul style="list-style-type: none"> ● Hold: Start/Stop recording videos. ● Double-Press: Correct non-uniformity of display (Flat Field Calibration, FFC). Menu Mode: Move up.
5	 Mode Key	Non-Menu Mode: <ul style="list-style-type: none"> ● Press: Switch palettes. ● Hold: Enter the menu. Menu Mode: <ul style="list-style-type: none"> ● Press: Confirm/Set parameters. ● Hold: Save and exit menu.
6	▽ Down Key (Clip-On Mode)	Non-Menu Mode (<i>LRF Model</i>): <ul style="list-style-type: none"> ● Press: Turn on laser ranging. ● Hold: Show/Hide OSD (On Screen Display). ● Double-Press: Turn off laser. Non-Menu Mode (<i>Non-LRF Model</i>): <ul style="list-style-type: none"> ● Hold: Show/Hide OSD (On Screen Display). Menu Mode: Move down.
	▽ Down Key (Monocular Mode)	Non-Menu Mode (<i>LRF Model</i>): <ul style="list-style-type: none"> ● Press: Turn on laser ranging. ● Hold: Switch digital zoom. ● Double-Press: Turn off laser. Non-Menu Mode (<i>Non-LRF Model</i>): <ul style="list-style-type: none"> ● Press: Switch digital zoom. ● Hold: Show/Hide OSD (On Screen Display). Menu Mode: Move down.
7	Fixing Ring	Holds the clip-on eyepiece in place.
8	 Power Key	<ul style="list-style-type: none"> ● Press: Standby mode/Wake up device. ● Hold: Power on/off.
9	Type-C Interface	To connect the device to power supply or transmit data with a type-C cable.
10	Battery Compartment	For holding the battery.



Note

- The power indicator stays solid red when the device is on.
 - When the auto screen off function is enabled, if you press  to enter standby mode, you can also tilt or rotate the device to wake up the device. Refer to **Auto Screen Off** for detailed operation.
-

2 Preparation

2.1 Install Battery

2.1.1 Battery Instruction

- The device supports removable li-ion battery. The charging limited voltage of the battery is 4.2 V. The battery capacity is 3.6 V/4.4 Ah (15.84 Wh).
- Charge the battery for more than 4 hours before first use.
- Remove the battery if the device is not used for a long time.

2.1.2 Change Battery

Before You Start

Ensure to power off the device before removing the battery.

Steps

1. Lift the battery compartment cover handle and pull the battery compartment cover outwards.

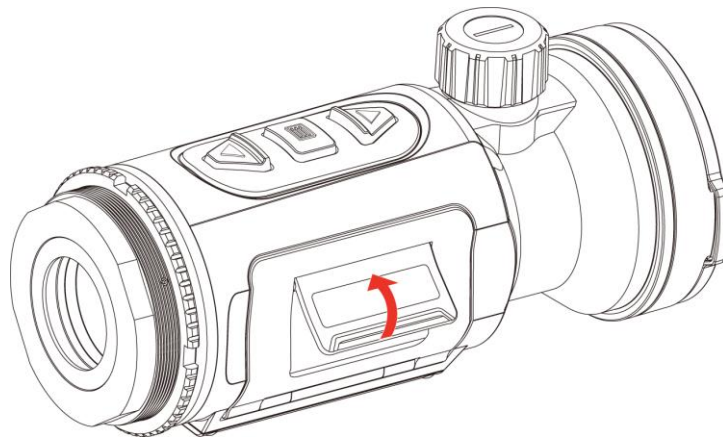

Figure 2-1 Open the Battery Compartment Cover

2. Push the battery latch aside (as the arrow shows), and release the battery.

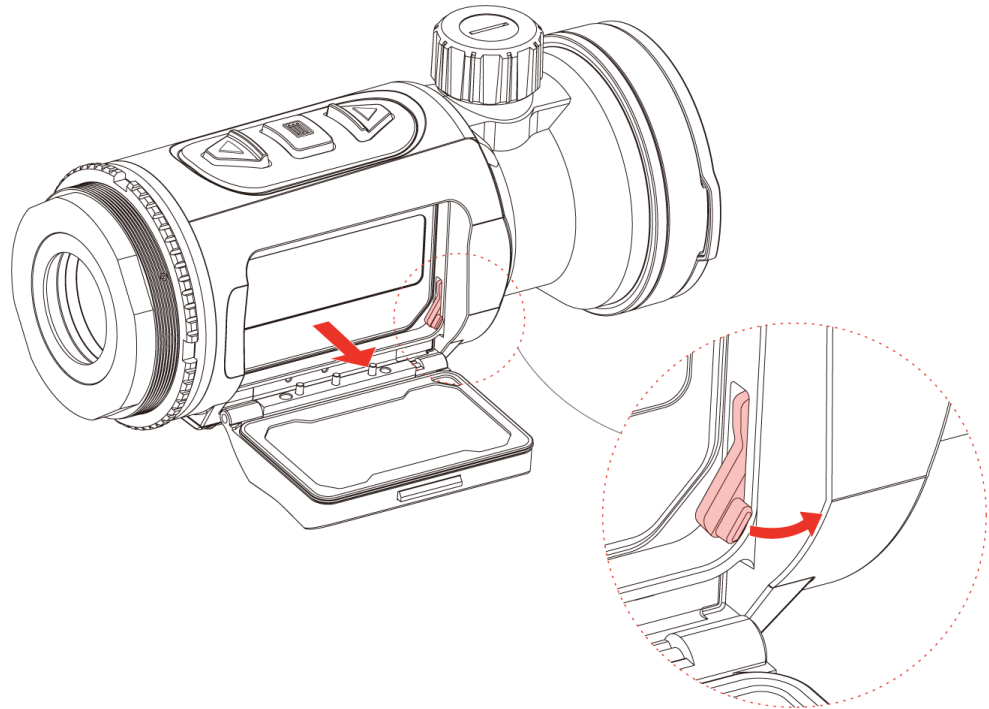

Figure 2-2 Unlatch the Battery Latch

3. Insert the battery into the battery compartment. The latch locks the battery in place when the battery is fully inserted.

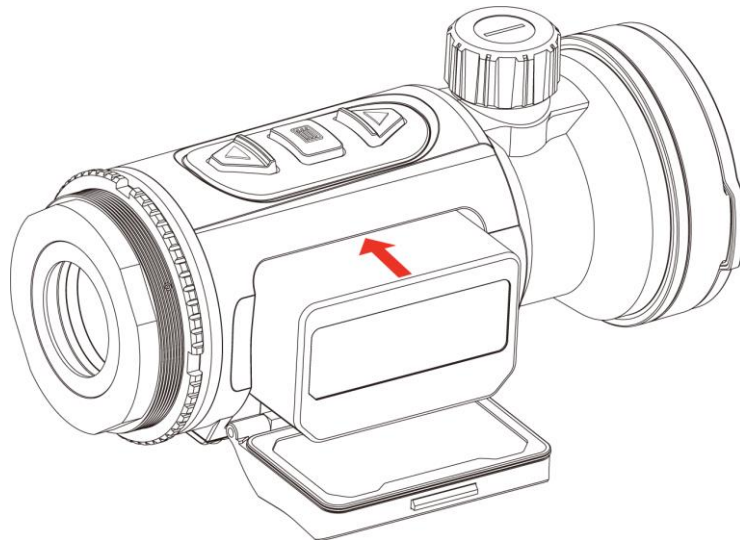

Figure 2-3 Insert the Battery

4. Push the battery compartment cover until it clicks into the locked position.

2.2 Connect Device

Steps

1. Lift the cable interface cover.
2. Connect the device and power adapter with a type-C cable to power on the device. Alternatively, connect the device and PC to export files.

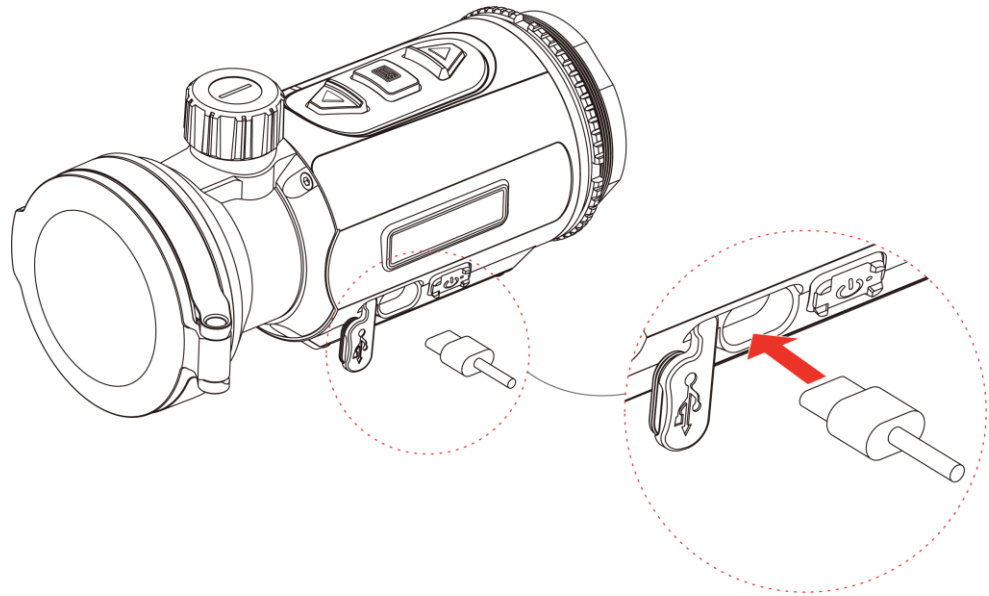

Figure 2-4 USB Connection

2.3 Install Monocular Eyepiece

Steps

1. Rotate the eyepiece clockwise until it tightened securely.

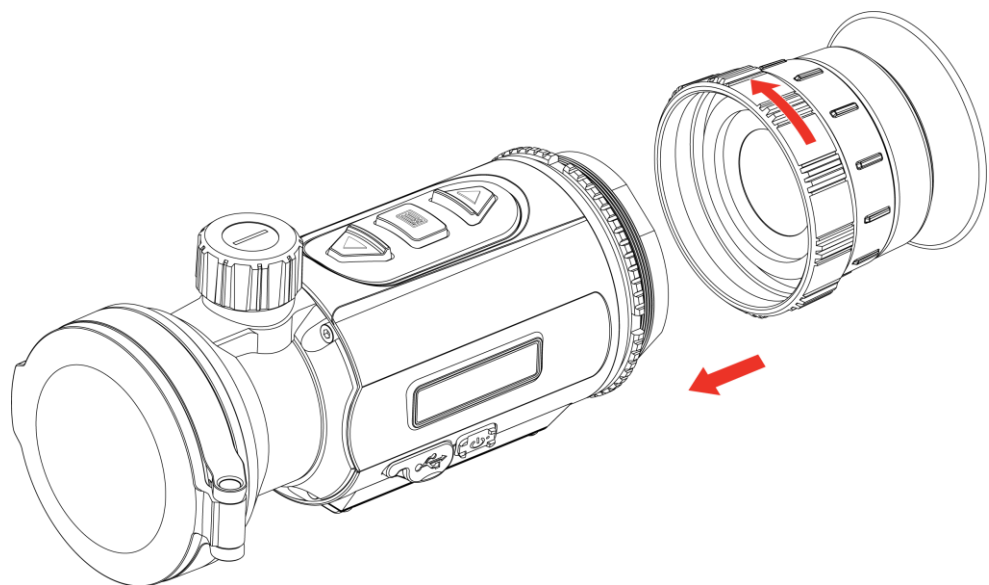

Figure 2-5 Install Eyepiece

2. Use the wrench in the package to tighten the fixing ring until the adapter is fixed on the device.



Note

- The eyepiece is not included in the package. Please purchase it separately as needed.
 - The thread size is M52 × 0.75 mm. Purchase the eyepiece recommended by the manufacturer.
-

2.4 Install Adapter

Install an adapter if you want to connect the device to a daylight scope.

Steps

1. Rotate the adapter clockwise until it tightened securely.

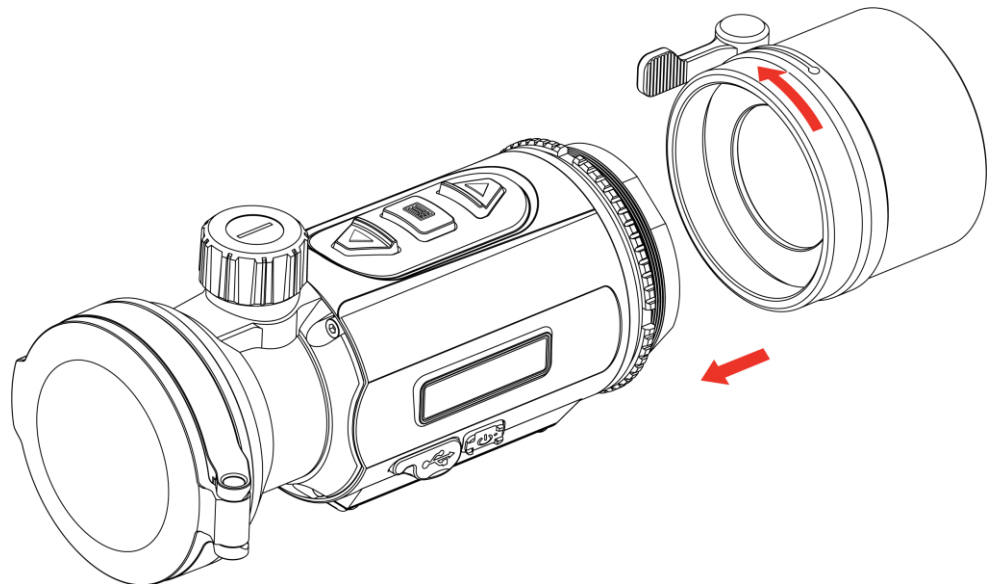

Figure 2-6 Install Adapter

2. Use the wrench in the package to tighten the fixing ring until the adapter is fixed on the device.



Note

- The adapter is not included in the package. Please purchase it separately as needed.
 - The thread size is M52 × 0.75 mm. Purchase the adapter recommended by the manufacturer.
-

2.5 Remove Adapter

Steps

1. Rotate the adapter counterclockwise to loosen it.
2. Remove the adapter carefully.

2.6 Install Daylight Scope

You can use the device together with a daylight scope to view the target clear in daytime.

Steps

1. Install the daylight scope into the adapter (shown as arrow 1).
2. Lock the buckle to fix the daylight scope (shown as arrow 2).
3. Loosen the buckle to remove the daylight scope (shown as arrow 3).

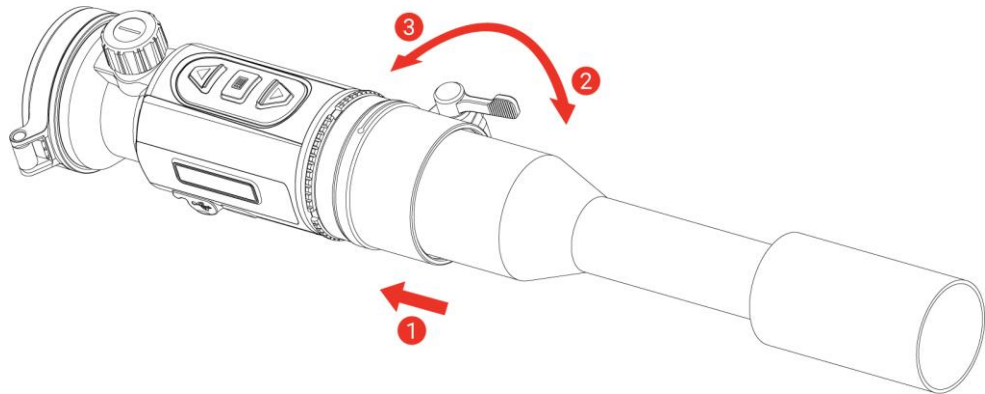

Figure 2-7 Install Daylight Scope



Note

- If the buckle overlaps the scope and cannot be locked in place, tighten the fixing ring slightly to lock the buckle.
 - The daylight scope is not included in the package. Please purchase it separately as needed.
-

2.7 Power On/Off

Power On

When the battery is sufficiently charged, hold  to power on the device.

Power Off

When the device is turned on, hold  to power off the device.











Note

- Power-off countdown will appear when you power off the device. You can press any key to interrupt the countdown and cancel the power-off.
 - Automatic low battery power-off cannot be canceled.
-

Auto Power Off



You can set the auto power off time for your device.

Steps

1. Hold  to show the menu.
 2. Go to  **Advanced Settings**, and press  or  to select .
 3. Press  or  to select the auto power off time as needed, and press  to confirm.
 4. Hold  to save the settings and exit.
-











Note

- See the battery icon for the battery status.  means the battery is fully charged,  means that the battery is low, and  means the battery charging is abnormal.
 - When the low power note shows, charge the battery.
 - The auto power off takes effect only when the device isn't in operation or connected with HIKMICRO Sight app.
 - The auto power off countdown will start again when the device exits standby mode, or the device is restarted.
-

2.8 Auto Screen Off

Auto screen off function darkens the screen to save energy and extend battery life.

Steps

1. Enable auto screen off.
 - 1) Hold  to show the menu.
 - 2) Go to  **Advanced Settings**, and press  or  to select .
 - 3) Press  to enable auto screen off.
 - 4) Hold  to save settings and exit.
2. The device will enter standby mode by one of the following operations when the display is turned on:
 - Tilt the device downwards more than 70°.
 - Rotate the device horizontally more than 45°.
3. You can wake up the device by one of the following operations when the display is turned off:
 - Tilt the device downwards from 0° to 70° or upwards.
 - Rotate the device horizontally from 0° to 45°.
 - Press  to wake up the device.

2.9 Menu Description

In the live view interface, hold  to show the menu.



- Press  to move up.
- Press  to move down.
- Press  to confirm.



Figure 2-8 Device Menu (Clip-On Mode)



Figure 2-9 Device Menu (Monocular Mode)

2.10 App Connection

Connect the device to the HIKMICRO Sight app via hotspot, and then you can capture picture, record video, or configure parameters on your phone.

Steps









1. Search the HIKMICRO Sight app on App Store (iOS System) or Google Play™ (Android System) to download it, or scan the QR code to download and install the app.



Android System



iOS System

2. Hold  to show the menu.
3. Go to  **Advanced Settings**, and press  or  to select .
4. Press  to enter the setting interface.
5. Press  or  to select **Hotspot**. The hotspot function is enabled and the hotspot password is displayed.
6. Turn on the WLAN of your phone and connect to the hotspot.
 - Hotspot Name: HIKMICRO_Serial No.
 - Hotspot Password: Go to **Hotspot** in the menu to check the password.
7. Open the app and connect your phone with the device. You can view the interface of device on your phone.



Note

- The device cannot connect to the app if entering wrong password several times. Refer to **Restore Device** to reset the device, and connect the app again.
 - The hotspot will be turned off if there is no connection for over 10 minutes.
-

2.11 Firmware Status

2.11.1 Check Firmware Status

Steps

1. Open the HIKMICRO Sight and connect your device to the app.
2. Check if there is an upgrade prompt on the device management interface. If there is no upgrade prompt, the firmware is the latest version. Otherwise, the firmware is not the latest version.

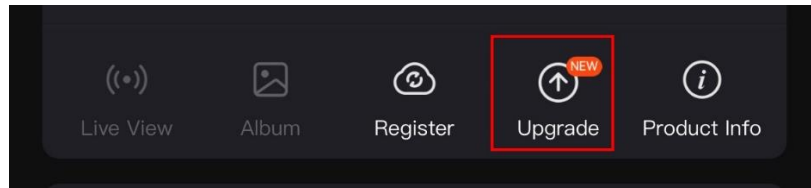

Figure 2-10 Check Firmware Status

3. (Optional) If the firmware is not the latest version, upgrade the device. See **Upgrade Device**.

2.11.2 Upgrade Device

Upgrade Device via HIKMICRO Sight

Steps

1. Open HIKMICRO Sight app and connect your device to the app.
2. Tap the upgrade prompt to enter the firmware upgrade interface.
3. Tap **Upgrade** to start upgrade.



Note

The upgrading operation may vary due to app updates. Please take the actual app version for reference.

Upgrade Device via PC

Before You Start

Please get the upgrade package first.

Steps

1. Hold to show the menu.
2. Go to **Advanced Settings**, and press \triangle or ∇ to select .
3. Press to enter the configuration interface.
4. Press \triangle or ∇ to select **USB Flash Drive**.
5. Connect the device to your PC with the type-C cable.
6. Open the detected disk, copy the upgrade file and paste it to the root directory of the device.
7. Disconnect the device from your PC.
8. Reboot the device, and the device upgrades automatically. The upgrading process will be displayed in the main interface.



Caution

During the upgrade package transmission, make sure the device is connected to your PC. Otherwise, it may cause unnecessary upgrade failure, firmware damage, etc.

2.12 Calibrate Image (Overview)

You can adjust and save the position of the image window for different users. See **Calibrate Image** for detailed instructions.



Note

This function is only available in Clip-On mode.



Figure 2-11 Image Calibration

2.13 Reference Line (Overview)

The reference line can help you aim at the target with high accuracy. See **Reference Line** for detailed instructions.



Note

This function is only available in Clip-On mode.

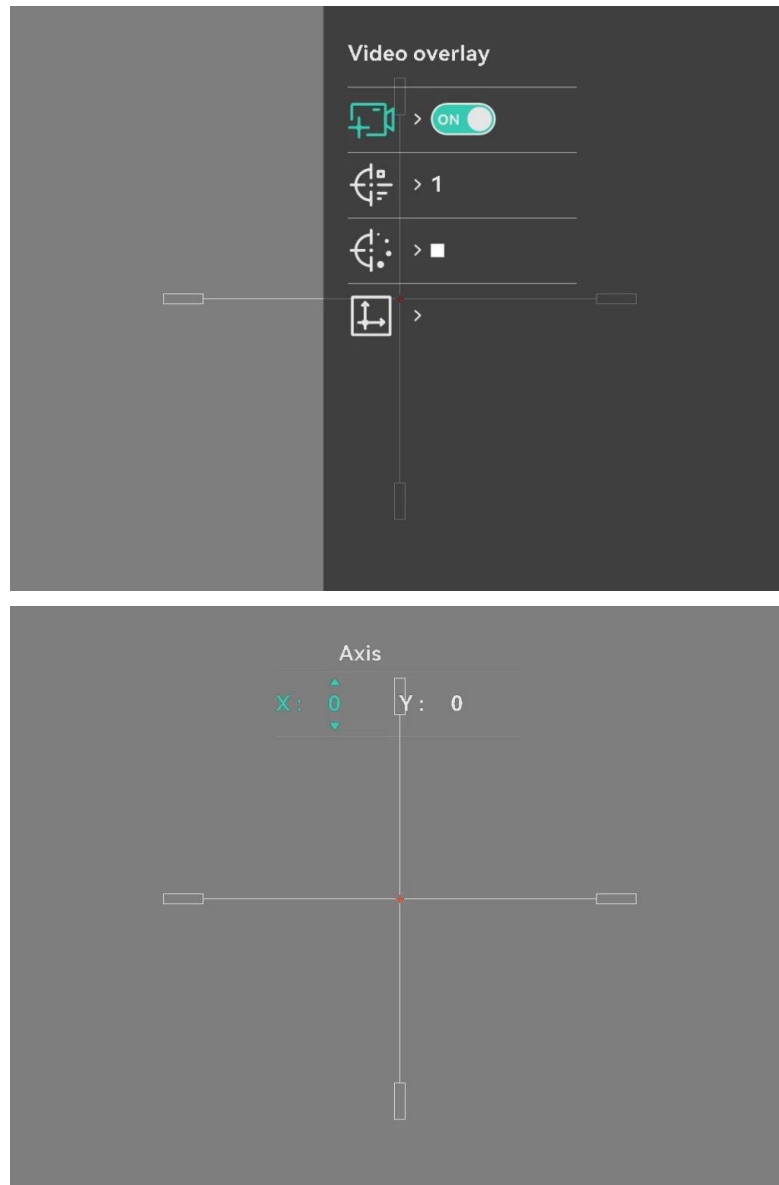

Figure 2-12 Reference Line

3 Image Settings

3.1 Adjust Focus

Steps

1. Power on the device.
2. Open the lens cover.
3. Hold the device and make sure the eyepiece covers your eye.
4. Adjust the focus knob until the image is clear.

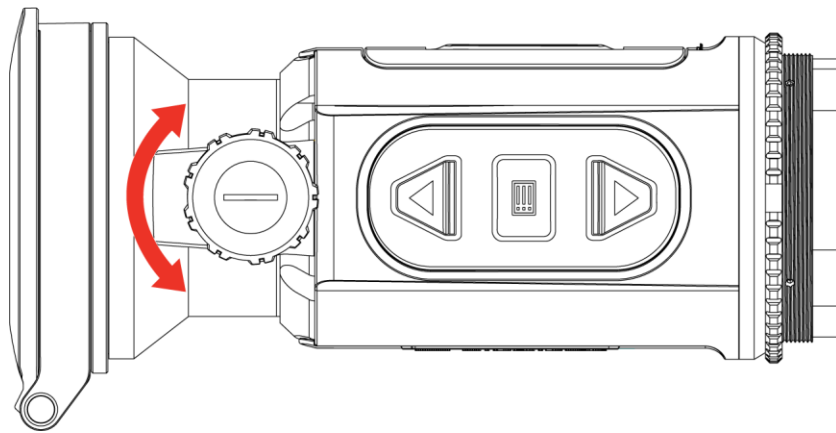

Figure 3-1 Adjust Focus











Note

When adjusting focus, DO NOT touch the surface of lens to avoid smearing the lens.

3.2 Adjust Brightness









You can adjust the display brightness of the screen in the menu.

Steps

1. Hold  to show the menu.
2. Press  or  to select  and press  to confirm.
3. Press  or  to adjust display brightness.
4. Hold  to save the settings and exit.

3.3 Adjust Contrast

Steps

1. Hold  to show the menu.
2. Press  or  to select  and press  to confirm.
3. Press  or  to adjust contrast.
4. Hold  to save and exit.

3.4 Adjust Tone

Steps







1. Hold  to show the menu.
2. Go to  **Advanced Settings**, select  and press  to confirm.
3. Press  or  to select a tone. **Warm** and **Cold** can be selected.
4. Hold  to save and exit.



Figure 3-2 Warm Tone



Figure 3-3 Cold Tone

3.5 Adjust Sharpness

Steps







1. Hold  to show the menu.
2. Go to  **Advanced Settings**, select  and press  to confirm.
3. Press  or  to adjust sharpness.
4. Hold  to save and exit.



Figure 3-4 Sharpness 1











Figure 3-5 Sharpness 5

3.6 Select Scene Mode

You can select proper scene according to actual using scene to improve the display effect.

Steps





1. Hold  to show the menu.
2. Go to  **Advanced Settings**, select  and press  to confirm.
3. Press  or  to select scene modes, and press  to confirm.
 - **Recognition**: Recognition mode is recommended in normal scene.
 - **Jungle**: Jungle mode is recommended in hunting environment.
4. Hold  to save settings and exit.





3.7 Set Palettes

You can select different palettes to display the same scene in different effects.

3.7.1 Custom Enabled Palettes

Steps

1. Hold  to show the menu.
2. Go to  **Advanced Settings**, press  or  to select .

3. Press  to enter the settings interface.
4. Press  or  to select the palettes as needed, and press  to enable them.



Note

At least one palette should be enabled.

5. Hold  to save the settings and exit.

3.7.2

Switch Palettes

Press  in live view interface to switch the selected palettes.

White Hot

The hot part is light-colored in view. The higher the temperature is, the lighter the color is.



Black Hot

The hot part is black-colored in view. The higher the temperature is, the darker the color is.



Red Hot

The hot part is red-colored in view. The higher the temperature is, the redder the color is.



Fusion

From high temperature to low temperature, the image is colored in from white, yellow, red, pink to purple.



Red Monochrome

The whole image is red colored. The higher the temperature is, the lighter the color is.



Green Monochrome





The whole image is green colored. The higher the temperature is, the lighter the color is.



3.8 Switch Eyepiece Type

Hold \triangle +  in the live view to switch the device between Clip-On and Monocular mode. You can also switch eyepiece type by the following steps.

Steps

1. Hold  to show the menu.
2. Go to  **Advanced Settings**, and press \triangle or ∇ to select .
3. Press  to enter the setting interface.
4. Press \triangle or ∇ to switch the eyepiece type.
 - **Clip-On:** You can install an adaptor and a daylight scope in this mode.
 - **Monocular:** You can install a monocular eyepiece to use the device as a regular monocular.
5. Hold  to save the settings and exit.

3.9 Adjust Digital Zoom

You can zoom in and out the image by using this function. Hold ∇ (LRF model) or press ∇ (non-LRF model) in the live view interface to switch the digital zoom ratio, and the actual zoom ratio switches between 1x, 2x, 4x, and 8x.







Note

- This function is only available in Monocular mode.
 - When switching the digital zoom ratio, the left interface displays the actual magnification (Actual Magnification = Lens Optical Magnification × Digital Zoom Ratio). For example, the lens optical magnification is 2.8× and the digital zoom ratio is 2×, and the actual magnification is 5.6×.
 - The zoom ratio may vary according to different models. Please take the actual product for reference.
-

3.10 Set Picture in Picture Mode

Steps

1. Hold  to show the menu.
2. Press  or  to select .
3. Press  to enable this function.

Result

When PIP is turned on, the image center is displayed in upper middle of the interface.



Figure 3-6 Set PIP Mode



Note

- This function is only available in Monocular mode.
 - If the PIP function is enabled, only the PIP view zooms when adjusting the digital zoom ratio.
-

3.11 Zoom Pro

Zoom Pro refers to zoomed image detail enhancement. When you turn on this function, the details of zoomed live view image will be enhanced.

Steps

1. Hold to show the menu.
2. Press or to select , and press to enable it.
3. Hold to save the settings and exit.

Result

The details of the zoomed live view image will be enhanced.



Note

This function is only available in Monocular mode.

3.12 Flat Field Correction

This function can correct non-uniformity of display.











Steps

1. Hold to show the menu.
2. Go to **Advanced Settings**, press or to select **Image Calib.**
3. Press or to switch the FFC modes, and press to confirm.
 - **Manual:** Double-press in live view to correct non-uniformity of display.
 - **External:** Cover the lens cover, and then double-press in live view to correct non-uniformity of display.
4. Hold to save the settings and exit.

3.13 Correct Defective Pixel

The device can correct the defective pixels on the screen which are not performed as expected.

Steps

1. Hold  to show the menu.
2. Go to  **Advanced Settings**, press  or  to select .
3. Press  to enter the DPC setting interface.
4. Press  to select the X or Y axis, and press  or  to set the coordinates until the cursor reaches the dead pixel. If you select X, the cursor moves left and right; if you select Y, the cursor moves up and down.
5. Double-press  to correct the dead pixel.
6. Hold  to save and exit.



Note

- The selected defective pixel can be magnified on the display.
 - If the screen OSD blocks the defective pixel, move the cursor to reach the defective pixel, then the device performs mirror display automatically.
-

3.14 Calibrate Image











You can adjust and save the position of the image window for different users.



Note

This function is only available in Clip-On mode.

Steps

1. Hold  to show the menu.
2. Go to  **Advanced Settings**, and press  and  to select .
3. Press  to enter the setting interface.
4. Select , press  and press  and  to set the menu display size.

















5. Select , press  and press  and  to switch calib. profiles.
6. Select , press  and press  and  to set the distance to the target.
7. (Optional) Select  to freeze the image.
8. Select  and press  to select X or Y axis, and then press  and  to set the coordinates until the window reaches the target.



Figure 3-7 Image Calibration

9. (Optional) Press  and  to select , and press  to confirm. Select **OK** to restore the view to default position, or select **CANCEL** to return to the setting interface.



Note

The default position of image window may not be exactly at zero ($X = 0$, $Y = 0$). This is caused by slight individual differences of optical components, and it is not a malfunction.

10. Hold  to exit image calibration.

3.15 Reference Line











The reference line can help you aim at the target with high accuracy.



Note

- This function is only available in Clip-On mode.
 - Due to laws and regulations, the live view will be suspended when enabling the reference line. (This prompt also pops up when entering **Ref. Line** interface. Press any key to close it.)
-

Steps

1. Hold  to show the menu.
2. Go to  **Advanced Settings**, and select .
3. Press  to enter the setting interface.
4. Select  to enable the video overlay. You can view the prerecord video when enabling this function.
5. Select  and  to set the reference line type and color.
6. Select  to adjust the reference line position. Press  to switch **X** and **Y** axis, and press  and  to set the coordinates until the reference line aligns with the point of impact.

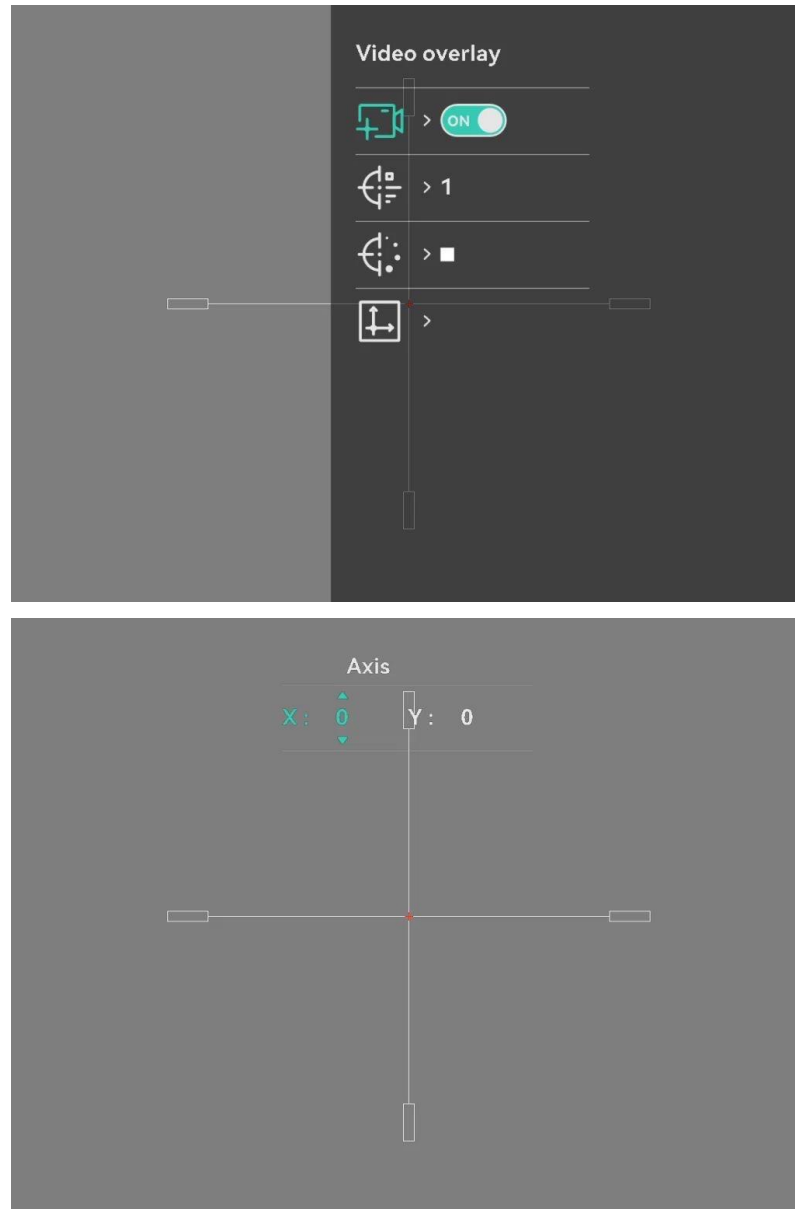



Figure 3-8 Adjust Reference Line

7. Trigger an activation again to verify that the aiming point aligns with the point of impact.
8. Hold  to exit the interface according to the prompt.
 - **OK:** Save the parameters and exit.
 - **CANCEL:** Exit without saving the parameters.













4 Measure Distance (LRF Model)

The device with an LRF module in the lens can detect the distance between the target and the observation position with laser.

Before You Start

When measuring the distance, keep the hand and the position steady. Otherwise, the accuracy may be affected.

Steps

1. Hold  to show the menu.
2. Go to  **Advanced Settings**, press  and  to select .
3. Press  to enter the setting interface.
4. Press  and  to select a laser ranging mode and press  to confirm. **Once** and **Continuous** are selectable.
 - **Once**: Measure the distance once.
 - **Continuous**: Measure the distance continuously, and the measurement duration can be selected. The measurement result will be refreshed every 1 s.
5. Hold  to return to the live view interface.
6. Aim the cursor at the target, press  to show the laser icon and press  again to measure the target distance.



Note

Double-press  to turn off laser ranging.

Result

The distance measurement result is displayed on the image.











Figure 4-1 Distance Measurement Result

5 General Settings

5.1 Set OSD

You can choose whether to display the OSD information on the live view interface.





Steps

1. Hold  to show the menu.
2. Go to  **Advanced Settings**, and select .
3. Press  to enter OSD setting interface.
4. Press  and  to select the **Time, Date, or OSD**, and press  to turn on or turn off the selected OSD information.
5. Hold  to save and exit.

5.2 Set Brand Logo

You can add brand logo to the live view interface, snapshots, and videos.

Steps

1. Hold  to show the menu.
2. Go to  **Advanced Settings**, and select .
3. Press  to enable or disable **Brand Logo**.
4. Hold  to save the settings and exit.



Result



The brand logo is displayed at the bottom left of the image.

5.3 Burning Prevention

Avoid direct sunlight and enable the Burning Prevention function to reduce the risk of sensor damage from the heat.

Steps

1. Hold  to show the menu.
2. Go to  **Advanced Settings**, and select .

3. Press  to enable or disable the **Burn Prevention** function.
4. Hold  to save settings and exit.

5.4 Capture and Video

5.4.1 Capture Picture

In the live view mode, press  to capture picture.







Note

- When capturing succeeds, the image freezes for 1 second and a prompt shows on the display.
 - For exporting captured pictures, refer to **Export Files**.
-

5.4.2 Set Audio

If you enable the audio function, the sound will be recorded with the video. When there is too loud noise in the video, you can turn off this function.

Steps

1. Hold  to show the menu.
2. Go to  **Advanced Settings**, and select .
3. Press  to enable or disable this function.
4. Hold  to save and exit.

5.4.3 Record Video

Steps

1. In the live view mode, hold  and start recording.



Figure 5-1 Record Video

2. Hold  again to stop recording.

5.4.4 Prerecord Video







After you enable this function and select the prerecording time, the device can automatically start recording the 5, 10 or 15 seconds before the recoil-activation and end recording the 5, 10 or 15 seconds after the recoil-activation.



Note

This function is only available in Clip-On mode.

Steps

1. Hold  to show the menu.
2. Go to  **Advanced Settings**, and select .
3. Press  to enter the setting interface. Press  and  to switch the prerecording time. 5 s, 10 s, and 15 s are selectable. You can also select **OFF** to turn off the function.
4. Hold  to save settings and exit.

5.4.5 Local Album

Captured images and recorded videos are automatically stored in the device, and you can view the files in local albums.

Steps







1. Hold  to show the menu.

2. Go to  **Advanced Settings**, and select .







Note

The albums are automatically created and named by year + month. The local pictures and videos of a certain month are stored in the corresponding album. For example, the pictures and videos of June in 2024 are saved in the album named 202406.

3. Press  and  to select an album and press  to enter it.
 4. Press  and  to select a file to view.
 5. Press  to view the selected file.
-



Note

- Files are arranged in chronological order, with the most recent at the top. If you fails to find the most recently taken snapshots or videos, please check the time and date settings of your device. When you are viewing files, you can switch to other files by pressing  and .
 - When you are viewing videos, you can press  to play or stop the video.
 - For deleting an album or a file, you can press  +  to call the dialogue box, and delete the album or file according to the prompt.
-

5.5 Export Files

5.5.1 Export Files via HIKMICRO Sight

You can access device albums and export files to your phone via HIKMICRO Sight.

Before You Start

Install HIKMICRO Sight on your mobile phone.

Steps

1. Open HIKMICRO Sight and connect your device to the app. See **App Connection**.
2. Tap Media to access device albums.

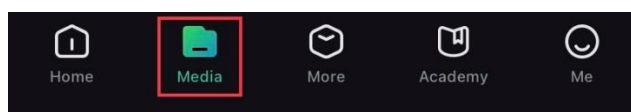

Figure 5-2 Access Device Albums

3. Tap **Local** or **Device** to view the photos and videos.
 - **Local**: You can view the previous files on the app.
 - **Device**: You can view the files of the current device.



Note

The photos or videos may not show in Device. Please pull down to refresh the page.

4. Tap to select a file, and tap Download to export the file to your local phone albums.



Figure 5-3 Export Files



Note

- Go to **Me > About > User Manual** on the app to see more detailed operations.
 - You can also access device albums by tapping bottom left icon in the live view interface.
 - The exporting operation may vary due to app updates. Please take the actual app version for reference.
-









5.5.2 Export Files via PC

This function is used to export recorded videos and captured pictures.

Before You Start

Make sure the device is turned on when connecting the cable.

Steps

1. Hold  to show the menu.
2. Go to  **Advanced Settings**, and press  or  to select .
3. Press  to enter the configuration interface.
4. Press  or  to select **USB Flash Drive**.
5. Connect the device and PC with the Type-C cable.



Note

- Make sure the device is turned on when connecting the cable.
 - Open computer disk and select the disk of device. Go to the DCIM folder and find the folder named after the capture year and month. For example, if you capture a picture or record a video on June 2024, go to DCIM -> 202406 to find the picture or video.
-

6. Select and copy the files to PC.

7. Disconnect the device from your PC.











Note

- The device displays images when you connect it to PC. But functions such as recording, capturing and hotspot are disabled.
 - When you connect the device to PC for the first time, it installs the drive program automatically.
-

6 System Settings













6.1 Adjust Date

Steps

1. Hold  to show the menu.
2. Go to  **Advanced Settings**, and select .
3. Press  to enter the configuration interface.
4. Press  to select the year, month, or day to be synchronized, and press  and  to change the number, then press  again to finish the setting.
5. Hold  to save settings and exit.

6.2 Adjust Time





Steps





1. Hold  to show the menu.
2. Go to  **Advanced Settings**, and select .
3. Press  to enter the configuration interface.
4. Press  and  to switch the clock system. 24-hour and 12-hour clock are selectable. If you select 12-hour clock, press  and then press  and  to select AM or PM.
5. Press  to select the hour or minute, and press  and  to change the number.
6. Hold  to save settings and exit.

6.3 Set Language

You can select the device language in this function.

Steps







1. Hold  to show the menu.
2. Go to  **Advanced Settings**, and select .
3. Press  to enter the language configuration interface.

4. Press  and  to select the language as required, and press  to confirm.
5. Hold  to save settings and exit.

6.4 Set Unit

You can switch the unit for distance display.

Steps

1. Hold  to show the menu.
2. Go to  **Advanced Settings**, and select .
3. Press  to enter the configuration interface.
4. Press  and  to select the unit as needed.
5. Hold  to save settings and exit.

6.5 Video Output (Analog)

With video output, you can debug the device or view the device image on an external display unit for details.









Note

This function is only available in Monocular mode.

Before You Start

Connect the device to the display unit via a USB Type-C to CVBS interface cable.

Steps

1. Hold  to show the menu.
2. Go to  **Advanced Settings**, and select .
3. Press  to enter the configuration interface.
4. Press  and  to select **Analog** and press  to confirm.
5. View the device image on the external display unit.



Note

The Type-C to CVBS cable is not included in the package.

6.6 Video Output (Digital)









The device supports casting screen to PC via a UVC protocol-based streaming media player. You can view the device image on the PC display for details.



Note





This function is only available in Clip-On mode.

Steps

1. Hold  to show the menu.
2. Go to  **Advanced Settings**, and select .
3. Press  to enter the configuration interface.
4. Press  and  to select **Digital** and press  to confirm.
5. Hold  to save the settings and exit.
6. Open the UVC protocol-based player, and connect your device to the PC via the type-C cable.





6.7 View Device Information

Steps

1. Hold  to show the menu.
2. Go to  **Advanced Settings**, and select .
3. Press  to view the device information such as version and serial No.
4. Hold  to exit.

6.8 Restore Device

Steps

1. Hold  to show the menu.
2. Go to  **Advanced Settings**, and select .
3. Press  to restore the device to defaults according to the prompt.

7 Frequently Asked Questions

7.1 Why is the monitor off?

Check whether the device is off-battery. Check the monitor after charging the device for 5 minutes.

7.2 Capturing or recording fails. What's the problem?

Check the following items.

- Whether the device is connected to your PC. Capturing or recording is turned off in this status.
- Whether the storage space is full.
- Whether the device is low-battery.

7.3 Why the PC cannot identify the device?

Check the following items.

- Whether the USB connection mode is **USB Flash Drive**.
- Whether the device is connected to your PC with supplied USB cable.
- If you use other USB cables, make sure the cable length is no longer than 1 m.

Legal Information

©Hangzhou Microimage Software Co., Ltd. All rights reserved.

About this Manual

The Manual includes instructions for using and managing the Product. Pictures, charts, images and all other information hereinafter are for description and explanation only. The information contained in the Manual is subject to change, without notice, due to firmware updates or other reasons. Please find the latest version of this Manual at the HIKMICRO website (www.hikmicrotech.com).

Please use this Manual with the guidance and assistance of professionals trained in supporting the Product.

Trademarks Acknowledgement

 **HIKMICRO** and other HIKMICRO's trademarks and logos are the properties of HIKMICRO in various jurisdictions.

Other trademarks and logos mentioned are the properties of their respective owners.

LEGAL DISCLAIMER

TO THE MAXIMUM EXTENT PERMITTED BY APPLICABLE LAW, THIS MANUAL AND THE PRODUCT DESCRIBED, WITH ITS HARDWARE, SOFTWARE AND FIRMWARE, ARE PROVIDED "AS IS" AND "WITH ALL FAULTS AND ERRORS". HIKMICRO MAKES NO WARRANTIES, EXPRESS OR IMPLIED, INCLUDING WITHOUT LIMITATION, MERCHANTABILITY, SATISFACTORY QUALITY, OR FITNESS FOR A PARTICULAR PURPOSE. THE USE OF THE PRODUCT BY YOU IS AT YOUR OWN RISK. IN NO EVENT WILL HIKMICRO BE LIABLE TO YOU FOR ANY SPECIAL, CONSEQUENTIAL, INCIDENTAL, OR INDIRECT DAMAGES, INCLUDING, AMONG OTHERS, DAMAGES FOR LOSS OF BUSINESS PROFITS, BUSINESS INTERRUPTION, OR LOSS OF DATA, CORRUPTION OF SYSTEMS, OR LOSS OF DOCUMENTATION, WHETHER BASED ON BREACH OF CONTRACT, TORT (INCLUDING NEGLIGENCE), PRODUCT LIABILITY, OR OTHERWISE, IN CONNECTION WITH THE USE OF THE PRODUCT, EVEN IF HIKMICRO HAS BEEN ADVISED OF THE POSSIBILITY OF SUCH DAMAGES OR LOSS.

YOU ACKNOWLEDGE THAT THE NATURE OF THE INTERNET PROVIDES FOR INHERENT SECURITY RISKS, AND HIKMICRO SHALL NOT TAKE ANY RESPONSIBILITIES FOR ABNORMAL OPERATION, PRIVACY LEAKAGE OR

OTHER DAMAGES RESULTING FROM CYBER-ATTACK, HACKER ATTACK, VIRUS INFECTION, OR OTHER INTERNET SECURITY RISKS; HOWEVER, HIKMICRO WILL PROVIDE TIMELY TECHNICAL SUPPORT IF REQUIRED.

YOU AGREE TO USE THIS PRODUCT IN COMPLIANCE WITH ALL APPLICABLE LAWS, AND YOU ARE SOLELY RESPONSIBLE FOR ENSURING THAT YOUR USE CONFORMS TO THE APPLICABLE LAW. ESPECIALLY, YOU ARE RESPONSIBLE, FOR USING THIS PRODUCT IN A MANNER THAT DOES NOT INFRINGE ON THE RIGHTS OF THIRD PARTIES, INCLUDING WITHOUT LIMITATION, RIGHTS OF PUBLICITY, INTELLECTUAL PROPERTY RIGHTS, OR DATA PROTECTION AND OTHER PRIVACY RIGHTS. YOU SHALL NOT USE THIS PRODUCT FOR ILLEGAL HUNTING ANIMALS, INVASION OF PRIVACY OR ANY OTHER PURPOSE WHICH IS ILLEGAL OR DETRIMENTAL TO THE PUBLIC INTEREST. YOU SHALL NOT USE THIS PRODUCT FOR ANY PROHIBITED END-USES, INCLUDING THE DEVELOPMENT OR PRODUCTION OF WEAPONS OF MASS DESTRUCTION, THE DEVELOPMENT OR PRODUCTION OF CHEMICAL OR BIOLOGICAL WEAPONS, ANY ACTIVITIES IN THE CONTEXT RELATED TO ANY NUCLEAR EXPLOSIVE OR UNSAFE NUCLEAR FUEL-CYCLE, OR IN SUPPORT OF HUMAN RIGHTS ABUSES.

PLEASE FOLLOW ALL THE PROHIBITIONS AND EXCEPTIONAL CAVEATS OF ALL APPLICABLE LAWS AND REGULATIONS, IN PARTICULAR, THE LOCAL FIREARMS AND/OR HUNTING LAWS AND REGULATIONS. PLEASE ALWAYS CHECK NATIONAL PROVISIONS AND REGULATIONS BEFORE PURCHASE OR USE OF THIS PRODUCT. PLEASE NOTE THAT YOU MAY HAVE TO APPLY FOR PERMITS, CERTIFICATES, AND/OR LICENSES BEFORE ANY PURCHASING, SELLING, MARKETING AND/OR USING OF THE PRODUCT. HIKMICRO SHALL NOT BE LIABLE FOR ANY SUCH ILLEGAL OR IMPROPER PURCHASING, SELLING, MARKETING, AND END USES AND ANY SPECIAL, CONSEQUENTIAL, INCIDENTAL, OR INDIRECT DAMAGES ARISING THEREOF.

IN THE EVENT OF ANY CONFLICTS BETWEEN THIS MANUAL AND THE APPLICABLE LAW, THE LATTER PREVAILS.

Regulatory Information

These clauses apply only to the products bearing the corresponding mark or information.

EU Conformity Statement



This product and - if applicable - the supplied accessories too are marked with "CE" and comply therefore with the applicable harmonized European standards listed under the Directive 2014/30/EU (EMCD), Directive 2014/35/EU (LVD), Directive 2011/65/EU (RoHS), Directive 2014/53/EU. Hereby, Hangzhou Microimage Software Co., Ltd. declares that this device (refer to the label) is in compliance with Directive 2014/53/EU.

The full text of the EU declaration of conformity is available at the following internet address:

[https://www.hikmicrotech.com/en/support/download-center/declaration-of-conformity/Frequency Bands and Power \(for CE\)](https://www.hikmicrotech.com/en/support/download-center/declaration-of-conformity/Frequency%20Bands%20and%20Power%20(for%20CE))

The frequency bands and transmitting power (radiated and/or conducted) nominal limits applicable to the following radio equipment are as follows:

Wi-Fi 2.4 GHz (2.4 GHz to 2.4835 GHz), 20 dBm

For the device without a supplied power adapter, use the power adapter provided by a qualified manufacturer. Refer to the product specification for detailed power requirements.

For the device without a supplied battery, use the battery provided by a qualified manufacturer. Refer to the product specification for detailed battery requirements.



Directive 2012/19/EU (WEEE Directive): Products marked with this symbol cannot be disposed of as unsorted municipal waste in the European Union. For proper recycling, return this product to your local supplier upon the purchase of equivalent new equipment, or dispose of it at designated collection points. For more information see: www.recyclethis.info



Regulation (EU) 2023/1542 (Battery Regulation): This product contains a battery and it is in conformity with the Regulation (EU) 2023/1542. The battery cannot be disposed of as unsorted municipal waste in the European



Union. See the product documentation for specific battery information. The battery is marked with this symbol, which may include lettering to indicate cadmium (Cd), or lead (Pb). For proper recycling, return the battery to your supplier or to a designated collection point. For more information see: www.recyclethis.info.

Industry Canada ICES-003 Compliance

This device meets the CAN ICES-003 (B)/NMB-003(B) standards requirements.

This device complies with Industry Canada license-exempt RSS standard(s). Operation is subject to the following two conditions:

- (1) this device may not cause interference, and
- (2) this device must accept any interference, including interference that may cause undesired operation of the device.

This equipment complies with IC RSS-102 radiation exposure limits set forth for an uncontrolled environment.

Conformité Industrie Canada ICES-003

Cet appareil répond aux exigences des normes CAN ICES-003 (B)/NMB-003 (B).

Cet appareil est conforme aux normes RSS exemptes de licence d'Industrie Canada. Son fonctionnement est soumis aux deux conditions suivantes :

- (1) cet appareil ne doit pas causer d'interférences, et
- (2) cet appareil doit accepter toute interférence reçue, notamment les interférences susceptibles d'occasionner un fonctionnement indésirable de l'appareil.

Cet appareil est conforme aux limites d'exposition au rayonnement IC RSS-102 établies pour un environnement non contrôlé.

INFORMATIONEN FÜR PRIVATE HAUSHALTE

1. Getrennte Erfassung von Altgeräten:

Elektro- und Elektronikgeräte, die zu Abfall geworden sind, werden als Altgeräte bezeichnet. Besitzer von Altgeräten haben diese einer vom unsortierten Siedlungsabfall getrennten Erfassung zuzuführen. Altgeräte gehören insbesondere nicht in den Hausmüll, sondern in spezielle

Sammel- und Rückgabesysteme.

2. Batterien und Akkus sowie Lampen:

Besitzer von Altgeräten haben Altbatterien und Altakkumulatoren, die nicht vom Altgerät umschlossen sind, die zerstörungsfrei aus dem Altgerät entnommen werden können, im Regelfall vor der Abgabe an einer Erfassungsstelle vom Altgerät zu trennen. Dies gilt nicht, soweit Altgeräte einer Vorbereitung zur Wiederverwendung unter Beteiligung eines öffentlich-rechtlichen Entsorgungsträgers zugeführt werden.

3. Möglichkeiten der Rückgabe von Altgeräten:

Besitzer von Altgeräten aus privaten Haushalten können diese bei den Sammelstellen der öffentlich-rechtlichen Entsorgungsträger oder bei den von Herstellern oder Vertriebern im Sinne des ElektroG eingerichteten Rücknahmestellen unentgeltlich abgeben. Rücknahmepflichtig sind Geschäfte mit einer Verkaufsfläche von mindestens 400 m² für Elektro- und Elektronikgeräte sowie diejenigen Lebensmittelgeschäfte mit einer Gesamtverkaufsfläche von mindestens 800 m², die mehrmals pro Jahr oder dauerhaft Elektro- und Elektronikgeräte anbieten und auf dem Markt bereitstellen. Dies gilt auch bei Vertrieb unter Verwendung von Fernkommunikationsmitteln, wenn die Lager- und Versandflächen für Elektro- und Elektronikgeräte mindestens 400 m² betragen oder die gesamten Lager- und Versandflächen mindestens 800 m² betragen. Verreiber haben die Rücknahme grundsätzlich durch geeignete Rückgabemöglichkeiten in zumutbarer Entfernung zum jeweiligen Endnutzer zu gewährleisten. Die Möglichkeit der unentgeltlichen Rückgabe eines Altgerätes besteht bei rücknahmepflichtigen Verreibern unter anderem dann, wenn ein neues gleichartiges Gerät, das im Wesentlichen die gleichen Funktionen erfüllt, an einen Endnutzer abgegeben wird.

4. Datenschutz-Hinweis:

Altgeräte enthalten häufig sensible personenbezogene Daten. Dies gilt insbesondere für Geräte der Informations- und Telekommunikationstechnik wie Computer und Smartphones. Bitte beachten Sie in Ihrem eigenen Interesse, dass für die Löschung der Daten auf den zu entsorgenden Altgeräten jeder Endnutzer selbst verantwortlich ist.



5. Bedeutung des Symbols „durchgestrichene Mülltonne“:



Das auf Elektro- und Elektronikgeräten regelmäßig abgebildete Symbol einer durchgestrichenen Mülltonne weist darauf hin, dass das jeweilige Gerät am Ende seiner Lebensdauer getrennt vom unsortierten Siedlungsabfall zu erfassen ist.

Symbol Conventions

The symbols that may be found in this document are defined as follows.

Symbol	Description
 Note	Provides additional information to emphasize or supplement important points of the main text.
 Caution	Indicates a potentially hazardous situation, which if not avoided, could result in equipment damage, data loss, performance degradation, or unexpected results.
 Danger	Indicates a hazard with a high level of risk, which if not avoided, will result in death or serious injury.

Safety Instruction

These instructions are intended to ensure that user can use the product correctly to avoid danger or property loss. Please read all the safety information carefully before using.

Transportation

- Keep the device in original or similar packaging while transporting it.
- Keep all wrappers after unpacking them for future use. In case of any failure occurred, you need to return the device to the factory with the original wrapper. Transportation without the original wrapper may result in damage on the device and the company shall not take any responsibilities.
- Do not drop the product or subject it to physical shock. Keep the device away from magnetic interference.

Power Supply

- If a power adapter is provided in the device package, use the provided adapter only. If no power adapter is provided, ensure the power adapter or other power supply complies with Limited Power Source. Refer to the product label for the power supply output parameters.
- The power delivered by the charger must be between min 5.5 Watts required by the radio equipment, and max 7.0 Watts in order to achieve the maximum charging speed.
- Make sure the plug is properly connected to the power socket.
- DO NOT connect multiple devices to one power adapter, to avoid overheating or fire hazards caused by overload.

Battery

- The device supports removable li-ion battery. The charging limited voltage of the battery is 4.2 V. The battery capacity is 3.6 V/4.4 Ah (15.84 Wh).
- CAUTION: Risk of explosion if the battery is replaced by an incorrect type. Replace with the same or equivalent type only.
- Batteries of improper size cannot be installed, and may cause abnormal shutdown.
- Improper replacement of the battery with an incorrect type may defeat a safeguard (for example, in the case of some lithium battery types).
- Please purchase the batteries recommended by the manufacturer if necessary.
- The purchased batteries by users need to comply with the relevant international standards about battery safety (e.g. EN/IEC standards).

- Use the battery provided by qualified manufacturer. Refer to the product specification for detailed battery requirements.
- Dispose of used batteries according to the instructions.
- Remove the battery if you do not use the device for a long time.
- For long-term storage of the battery, make sure it is fully charged every half year to ensure the battery quality. Otherwise, damage may occur.
- The built-in battery cannot be dismantled. Please contact the manufacture for repair if necessary.
- Install the external battery before the built-in battery runs out, or the device cannot be turned on.
- Make sure the battery temperature is between 0°C to 45°C (32°F to 113°F) when charging.
- Do not dispose of the battery into fire or a hot oven, or mechanically crush or cut the battery, which may result in an explosion.
- Do not leave the battery in an extremely high temperature or low air pressure environment, which may result in an explosion or the leakage of flammable liquid or gas.
- Confirm there is no flammable material within 2 m of the charger during charging.
- DO NOT place the device with battery or the battery alone near heating or fire source. Avoid direct sunlight.
- DO NOT place the battery in the reach of children.
- DO NOT swallow the battery to avoid chemical burns.
- This product contains a coin/button cell battery. If the coin/button cell battery is swallowed, it can cause severe internal burns in just 2 hours and can lead to death.
- If the battery compartment does not close securely, stop using the product and keep it away from children.
- If you think batteries might have been swallowed or placed inside any part of the body, seek immediate medical attention.

Maintenance

- If the product does not work properly, please contact your dealer or the nearest service center. We shall not assume any responsibility for problems caused by unauthorized repair or maintenance.
- Make sure that the power has been disconnected before device teardown and repair by professionals.
- Wipe the device gently with a clean cloth and a small quantity of ethanol, if necessary.
- If the equipment is used in a manner not specified by the manufacturer, the protection provided by the device may be impaired.
- Clean the lens with soft and dry cloth or wiping paper to avoid

scratching it.

Using Environment

- Make sure the running environment meets the requirement of the device. The operating temperature shall be -30 °C to 55 °C (-22 °F to 131 °F), and the operating humidity shall be from 5% to 95%.
- DO NOT expose the device to high electromagnetic radiation or dusty environments.
- DO NOT aim the lens at the sun or any other bright light.
- Place the device in a dry and well-ventilated environment.
- When any laser equipment is in use, make sure that the device lens is not exposed to the laser beam, or it may burn out.
- Avoid equipment installation on vibratory surface or places subject to shock (neglect may cause equipment damage).
- This equipment is not suitable for use in locations where children are likely to be present.

Emergency

If smoke, odor, or noise arises from the device, immediately turn off the power, unplug the power cable, and contact the service center.

Laser

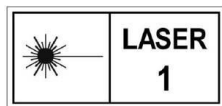

When any laser equipment is in use, make sure that the device lens is not exposed to the laser beam, or it may burn out. The laser radiation emitted from the device can cause eye injuries, burning of skin or inflammable substances. Before enabling the laser ranging function, make sure no human or inflammable substances are in front of the laser lens. Do not place the device where minors can fetch it. The wavelength is 905 nm, the pulse duration is 35 ns, and the max. average power output is 2 mW. According to IEC 60825-1:2014, EN 60825-1:2014+A11:2021, and EN 50689:2021, this laser product is classified as Class 1 laser product and consumer laser product.

Manufacture Address

Room 313, Unit B, Building 2, 399 Danfeng Road, Xixing Subdistrict,
Binjiang District, Hangzhou, Zhejiang 310052, China

Hangzhou Microimage Software Co., Ltd.

COMPLIANCE NOTICE: The thermal series products might be subject to export controls in various countries or regions, including without limitation, the United States, European Union, United Kingdom and/or other member

countries of the Wassenaar Arrangement. Please consult your professional legal or compliance expert or local government authorities for any necessary export license requirements if you intend to transfer, export, re-export the thermal series products between different countries.



 Hikmicro Hunting.Global

 Hikmicro Hunting.Global

 HIKMICRO Outdoor

 HIKMICRO

 www.hikmicrotech.com

 support@hikmicrotech.com

UD40566B