



Thermal Monocular LYNX 2.0 Series

User Manual V5.5.72 202312



Contact Us

CONTENTS

1	Overview.....	1
1.1	Main Function	1
1.2	Appearance	1
2	Preparation.....	5
2.1	Install Battery	5
2.1.1	Battery Instruction	5
2.1.2	Battery Installation.....	5
2.2	Cable Connection	6
2.3	Power On/Off	7
2.4	Auto Screen Off	8
2.5	Menu Description.....	8
2.6	App Connection	9
2.7	Firmware Status.....	9
2.7.1	Check Firmware Status	9
2.7.2	Upgrade Device.....	10
3	Image Settings.....	12
3.1	Adjust Diopter	12
3.2	Adjust Focus	12
3.3	Adjust Brightness	13
3.4	Adjust Contrast	13
3.5	Adjust Tone.....	13
3.6	Adjust Sharpness.....	14
3.7	Select Scene	14
3.8	Set Palettes.....	15
3.9	Set Picture in Picture Mode	16
3.10	Adjust Digital Zoom	17
3.11	Flat Field Correction	17
3.12	Correct Defective Pixel	18
4	Measure Distance	20
5	General Settings.....	22
5.1	Set OSD	22

Thermal Monocular User Manual

5.2	Set Brand Logo	22
5.3	Burning Prevention	23
5.4	Capture and Video	23
5.4.1	Capture Picture	23
5.4.2	Set Audio	23
5.4.3	Record Video	24
5.5	Hot Tracking	24
5.6	Export Files	25
5.6.1	Export Files via HIKMICRO Sight	25
5.6.2	Export Files via PC	26
6	System Settings	28
6.1	Adjust Date	28
6.2	Synchronize Time	28
6.3	Set Language	28
6.4	Set Unit	29
6.5	CVBS Output	29
6.6	View Device Information	30
6.7	Restore Device	30
7	Frequently Asked Questions	31
7.1	Why does the charge indicator flash improperly?	31
7.2	Why is the power indicator off?	31
7.3	The image is not clear, how to adjust it?	31
7.4	Capturing or recording fails. What's the problem?	31
7.5	Why the PC cannot identify the device?	31

1 Overview

HIKMICRO LYNX 2.0 thermal monocular is equipped with a powerful infrared detector and a 1024 × 768 OLED display. Its high thermal sensitivity of less than 20 mK NETD ensures perfect image quality and detail recognition even in the hardest weather conditions. It can be applied mainly in forest & field hunting, birding, animal searching, and rescuing scenarios

1.1 Main Function

- **Hot Tracking:** The device can detect the highest temperature in the scene and mark the spot. This function varies according to different camera models.
- **Auto Screen Off:** The function allows the device to enter standby mode/wake up through angle changes. The function darkens the screen to save energy and increase battery time.
- **Video and Snapshot:** The built-in memory module supports video recording and snapshot capturing.
- **App Connection:** The device can capture snapshots, record videos, and set parameters by HIKMICRO Sight app after being connected to your phone via hotspot.

1.2 Appearance

Note

- The appearance may vary according to different models. Please take the actual product for reference.
 - Pictures in this manual are for illustration purpose only. Please take the actual product for reference.
-

Thermal Monocular User Manual

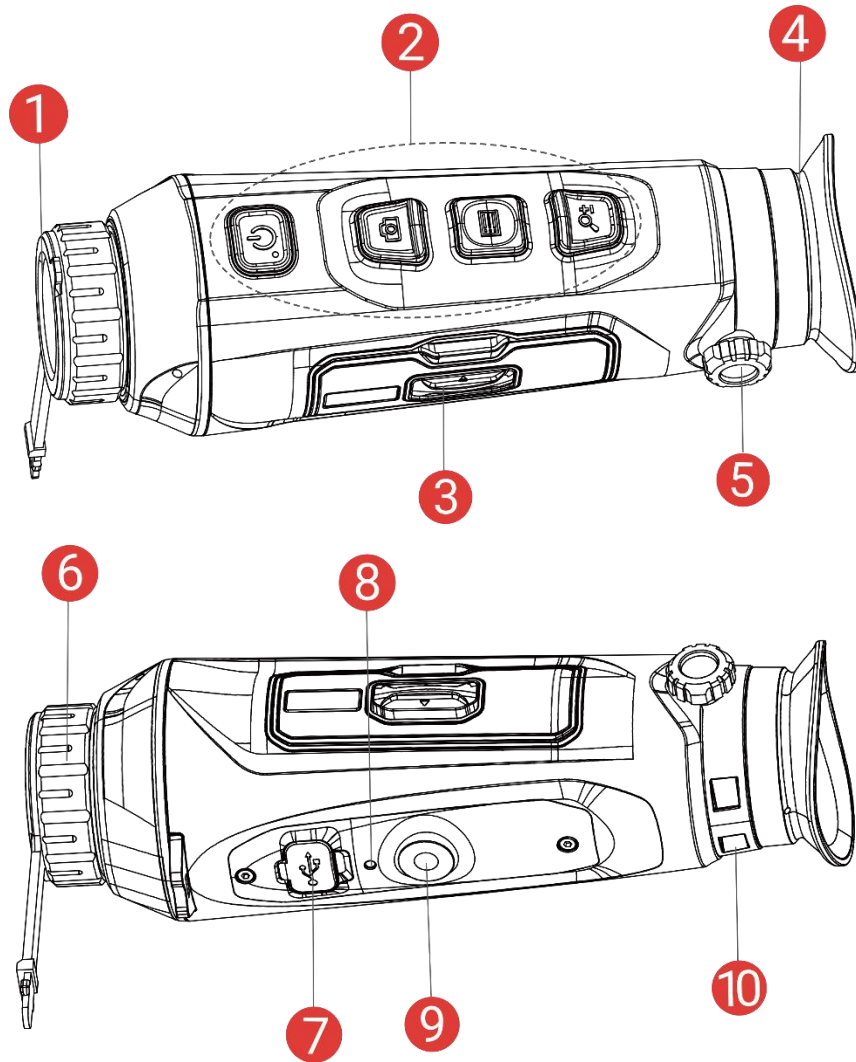

Figure 1-1 Appearance

Table 1-1 Description of Buttons and Components





No.	Component	Description
1	Lens Cover	Protects the lens.
2	Buttons	To set functions and parameters.
3	Battery Compartment	For holding the battery.
4	Eyepiece	The piece placed closest to the eye to view the target.
5	Diopter Adjustment Knob	Adjusts the dioptric setting.
6	Focus Ring	Adjusts focus to obtain clear targets.

Thermal Monocular User Manual

7	Type-C Interface	Power the device or transmit data with a type-C cable.
8	Charging Indicator	Indicates the charging status of the device. <ul style="list-style-type: none"> ● Flashing Red & Green: Error occurred. ● Solid Red: Charging. ● Solid Green: Fully charged.
9	Tripod Mount	Mounts the tripod.
10	Wrist Strap Hole	Mounts the wrist strap.

Button Description

Table 1-2 Button Description

Icon	Button	Function
	Power	<ul style="list-style-type: none"> ● Press: Standby mode/Wake up device. ● Hold: Power on/off.
	Capture	<p>Non-Menu Mode:</p> <ul style="list-style-type: none"> ● Press: Capture snapshots. ● Hold: Start/Stop recording videos. <p>Menu Mode: Press to move up.</p>
	Mode	<p>Non-Menu Mode:</p> <ul style="list-style-type: none"> ● Press: Switch palettes. ● Hold: Enter the menu. <p>Menu Mode:</p> <ul style="list-style-type: none"> ● Press: Confirm/Set parameters. ● Hold: Save and exit menu.
	Zoom	<p>Non-Menu Mode:</p> <ul style="list-style-type: none"> ● Press: Switch digital zoom. ● Hold: Correct non-uniformity of display (FFC). <p>Menu Mode: Press to move down.</p>

Note

- The power indicator stays solid red when the device is on.
-

Thermal Monocular User Manual

- When the auto screen off function is enabled, if you press  to enter standby mode, you can also tilt or rotate the device to wake up the device. Refer to *Auto Screen Off* for detailed operation.
-

2 Preparation

2.1 Install Battery

2.1.1 Battery Instruction

- Remove the external battery if the device is not used for a long time.
- The external rechargeable battery type is 18650, and the battery size should be 19 mm × 70 mm. The rated voltage is 3.6 V, and the battery capacity is 3200 mAh.
- To ensure better conductivity, if the battery compartment cover gets dirty, use a clean cloth to wipe the thread.

2.1.2 Battery Installation

Insert the batteries into the battery compartment.

Steps

1. Slide the battery compartment cover lock, as the arrow shows.

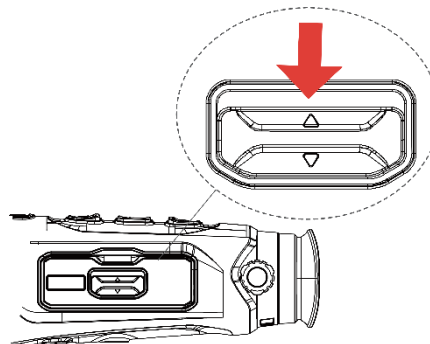

Figure 2-1 Unlock the Cover

2. Open the cover and insert the battery into the battery compartment as the positive and negative marks indicate.

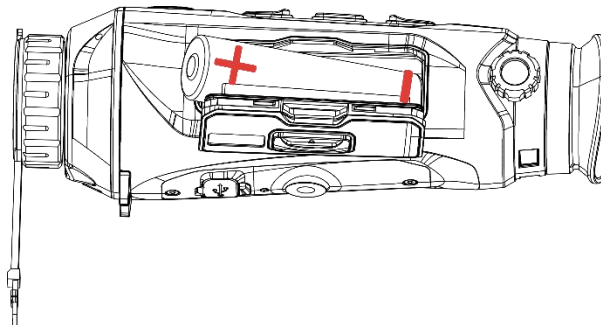

Figure 2-2 Inset the Battery

3. Close the battery compartment cover and lock it.

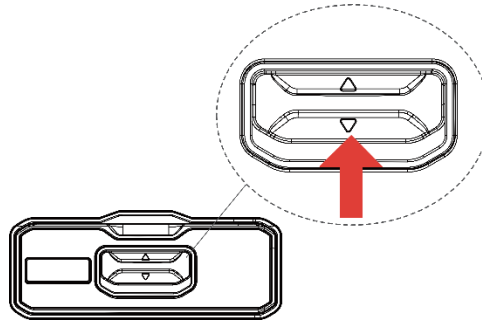

Figure 2-3 Close the Cover

2.2 Cable Connection

Before You Start

Make sure the battery is installed in the device.

Connect the device and power adaptor with a type-C cable to power on the device. Alternatively, connect the device and PC to export files.

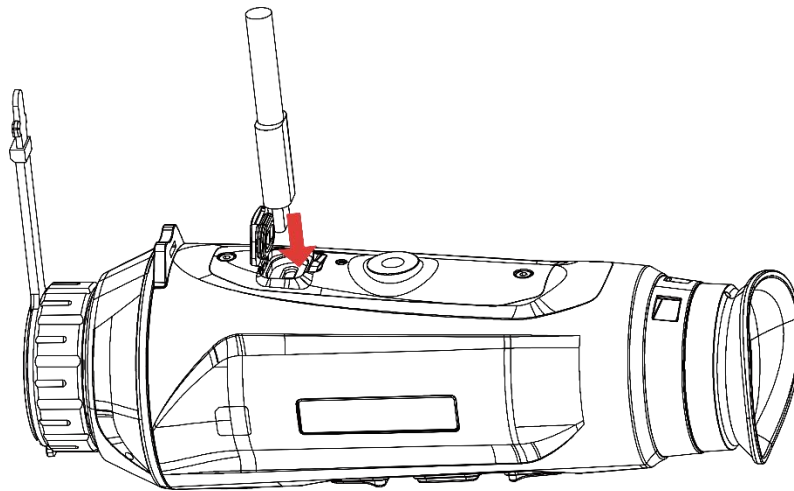



Figure 2-4 Cable Connection

Note

- Charge the device for more than 6 hours before first use.
 - You can also use the battery charger to charge the battery.
 - The charging temperature should be from 0 °C to 45 °C (32 °F to 113 °F).
-

2.3 Power On/Off

Power On

When the device is connected to cable or the battery is enough, hold  to power on the device.

Power Off

When the device is turned on, hold  to power off the device.











Note

- Power-off countdown will appear when you power off the device. You can press any key to interrupt the countdown and cancel the power-off.
 - Automatic low battery power-off cannot be canceled.
-



Auto Power Off

You can set the auto power off time for your device.

Steps

1. Hold  to show the menu.
 2. Go to  **Advanced Settings**, and select  **General Settings**.
 3. Press  or  to select , and press  to enter the configuration interface.
 4. Press  or  to select the auto power off time as required, and press  to confirm.
 5. Hold  to save and exit.
-









Note

- See the battery icon for the battery status.  means the battery is fully charged,  means that the battery is low, and  means the battery charging is abnormal.
 - When the low power note shows, charge the battery.
 - The auto power off takes effect only when the device enters the standby mode and the device isn't connected with HIKMICRO Sight app at the same time.
 - The auto power off countdown will start again when the device reenters standby mode, or the device is restarted.
-

2.4 Auto Screen Off

Auto screen off function darkens the screen to save energy and increase battery time.

Steps

1. Enable auto screen off.
 - 1) Hold  to show the menu.
 - 2) Go to  **Advanced Settings**, and press  or  to select  .
 - 3) Press  to enable auto screen off.
 - 4) Hold  to save settings and exit.
2. You can do one of the following methods to enter the standby mode when the display is turned on:
 - Tilt the device downwards more than 70°.
 - Rotate the device horizontally more than 75°.
 - Keep the device still and do not move it for 5 minutes.
3. You can do one of the following methods to wake up the device when the display is turned off:
 - Tilt the device downwards from 0° to 60° or upwards .
 - Rotate the device horizontally from 0° to 75°.
 - Press  to wake up the device.

2.5 Menu Description

In the live view interface, hold  to show the menu.

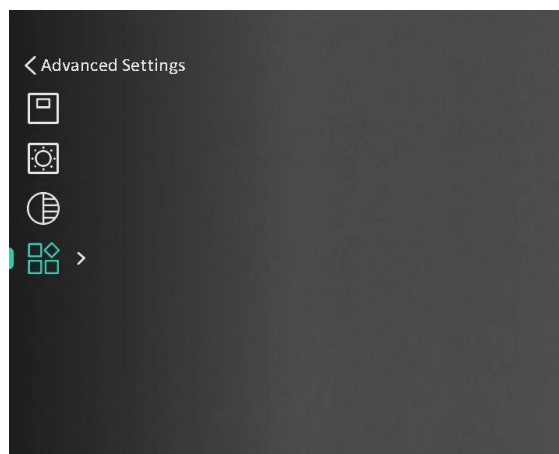

Figure 2-5 Menu Description

2.6 App Connection

Connect the device to the HIKMICRO Sight app via hotspot, then you can capture picture, record video, or configure parameters on your phone.

Steps









1. Search the HIKMICRO Sight on App Store (iOS System) or Google Play™ (Android System) to download it, or scan the QR code to download and install the app.



Android System



iOS System

2. Hold  to show the menu.
3. Go to  **Advanced Settings**, and Press  or  to select .
4. Press  to enter the setting interface.
5. Press  or  to select **Hotspot**. The hotspot function is enabled.
6. Turn on the WLAN of your phone and connect to the hotspot.
 - Hotspot Name: HIKMICRO_Serial No.
 - Hotspot Password: Serial No.
7. Open the app and connect your phone with the device. You can view the interface of device on your phone.

Note

- The device cannot connect to the app if you enter wrong password several times. Refer to **Restore Device** to reset the device, and connect the app again.
 - The device should be activated for the first use. The default password must be changed after the activation.
-

2.7 Firmware Status

2.7.1 Check Firmware Status

Steps

1. Open the HIKMICRO Sight and connect your device to the app.
2. Check if there is an upgrade prompt on the device management interface. If there is no upgrade prompt, the firmware is the latest version. Otherwise, the firmware is not the latest version.

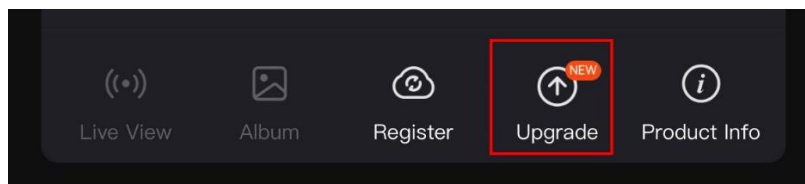

Figure 2-6 Check Firmware Status

3. (Optional) If the firmware is not the latest version, upgrade the device. See *Upgrade Device*.

2.7.2 Upgrade Device

Upgrade Device via HIKMICRO Sight

Steps

1. Open HIKMICRO Sight app and connect your device to the app.
2. Tap the upgrade prompt to enter the firmware upgrade interface.
3. Tap **Upgrade** to start upgrade.

Note







The upgrading operation may vary due to app updates. Please take the actual app version for reference.



Upgrade Device via PC

Before You Start

Please get the upgrade package first.

Steps

1. Hold  to show the menu.
2. Go to  **Advanced Settings**, and select  **Function Settings**.
3. Press  or  to select , and press  to enter the configuration interface.

4. Press  or  to select **USB Flash Drive**.
 5. Connect the device to your PC with cable.
 6. Open the detected disk, copy the upgrade file and paste it to the root directory of the device.
 7. Disconnect the device from your PC.
 8. Reboot the device, and the device upgrades automatically. The upgrading process will be displayed in the main interface.
-

 **Caution**

During the upgrade package transmission, make sure the device is connected to your PC. Otherwise, it may cause unnecessary upgrade failure, firmware damage, etc.

3 Image Settings

You can set palettes, brightness, scenes, FFC (flat field correction), and DPC (defective pixel correction) to display the better image effect.

3.1 Adjust Diopter

Make sure the eyepiece covers your eye and aim at the target. Adjust the diopter adjustment knob until the OSD text or image is clear.

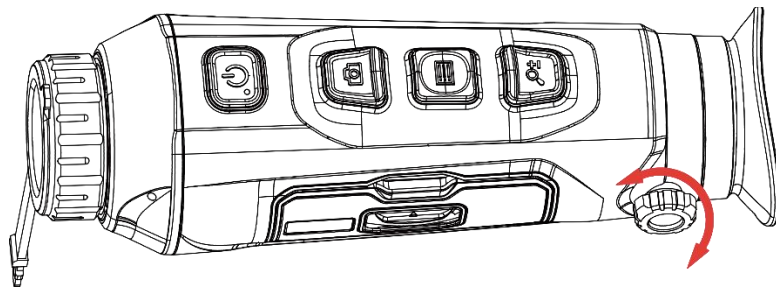

Figure 3-1 Adjust Diopter

Note

When adjusting diopter, DO NOT touch the surface of lens to avoid smearing the lens.

3.2 Adjust Focus

Slightly rotate the focus ring to adjust the focus of the objective lens.

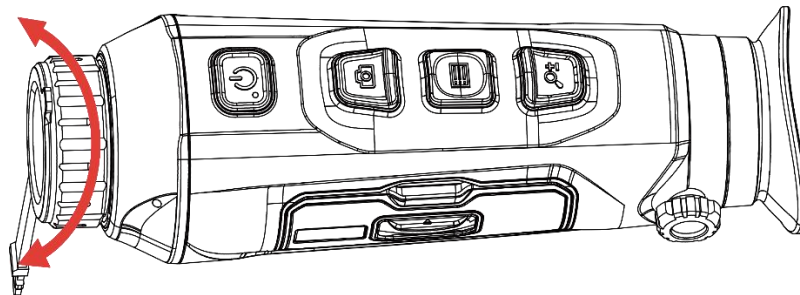

Figure 3-2 Adjust Focus









Note

- When focusing, do not touch the surface of lens to avoid smearing the lens.
 - This function varies according to different camera models.
-

3.3 Adjust Brightness









You can adjust the display brightness of the screen in the menu.

Steps

1. Hold  to show the menu.
2. Press  or  to select  and press  to confirm.
3. Press  or  to adjust display brightness.
4. Hold  to save settings and exit.









3.4 Adjust Contrast

Steps

1. Hold  to show the menu.
2. Press  or  to select  and press  to confirm.
3. Press  or  to adjust contrast.
4. Hold  to save settings and exit.

3.5 Adjust Tone

Steps

1. Hold  to show the menu.
2. Go to  **Advanced Settings**, and press  or  to select .
3. Press  to confirm, and press  or  to select a tone. **Warm** and **Cold** can be selected.
4. Hold  to save and exit.



Warm

Cold

Figure 3-3 Adjust Tone

3.6 Adjust Sharpness

Steps









1. Hold  to show the menu.
2. Go to  **Advanced Settings**, and press  or  to select .
3. Press  to confirm, and press  or  to adjust sharpness.
4. Hold  to save and exit.











Figure 3-4 Sharpness Adjustment Comparison

3.7 Select Scene

You can select proper scene according to actual using scene to improve the display effect.

Steps

1. Hold  to show the menu.
2. Go to  **Advanced Settings**, and press  or  to select .
3. Press  to enter the setting interface.
4. Press  or  to switch scene.
 - **Recognition:** Recognition refers to recognition mode and is recommended in normal scene.
 - **Jungle:** Jungle refers to jungle mode and is recommended in hunting environment.
5. Hold  to save settings and exit.

3.8 Set Palettes

You can select different palettes to display the same scene in different effects. Press  in the live view interface to switch palettes.

White Hot

The hot part is light-colored in view. The higher the temperature is, the lighter the color is.



Black Hot

The hot part is black-colored in view. The higher the temperature is, the darker the color is.



Red Hot

The hot part is red-colored in view. The higher the temperature is, the redder the color is.



Fusion

From high temperature to low temperature, the image is colored in from white, yellow, red, pink to purple.



3.9 Set Picture in Picture Mode

Steps







1. Hold  to show the menu.
2. Press  or  to select .
3. Press  to enable or disable PIP mode. The details show in the upper center of the view.
4. Hold  to save the settings and exit.



Figure 3-5 Set PIP Mode

Note

If the PIP function is enabled, only the PIP view zooms when adjusting the digital zoom ratio.

3.10 Adjust Digital Zoom

You can zoom in and out the image by using this function. Press  in the live view interface, the digital zoom ratio switches between 1×, 2×, 4× and 8×.







Note





When switching the digital zoom ratio, the left interface displays the actual magnification (Actual Magnification = Lens Optical Magnification × Digital Zoom Ratio). For example, the lens optical magnification is 2.8× and the digital zoom ratio is 2×, and the actual magnification is 5.6×.

3.11 Flat Field Correction

This function can correct non-uniformity of display.

Steps

1. Hold  to show the menu.
2. Go to  **Advanced Settings**, and select  **Function Settings**.
3. Press  or  to select , and press  to enter the configuration interface.

4. Press  or  to switch FFC mode.
 - **Manual FFC:** Hold  in the live view to correct the non-uniformity of display.
 - **Auto FFC:** The device performs FFC automatically according to the set schedule when switching on the camera.
 - **External:** Cover the lens cover, then hold  in the live view to correct the non-uniformity of display.
5. Hold  to save the settings and exit.













Note

The countdown will start before the device performs FFC automatically.

3.12 Correct Defective Pixel

The device can correct the defective pixels on the screen which are not performed as expected.

Steps

1. Hold  to show the menu.
2. Go to  **Advanced Settings**, and select  **Function Settings**.
3. Press  or  to select , and press  to enter DPC configuration interface.
4. Press  to select **X** or **Y Axis**. If you select **X** axis, the cursor moves left and right; if you select **Y** axis, the cursor moves up and down.
5. Press  or  to set the coordinates until the cursor reaches the defective pixel.
6. Press  twice to correct the dead pixel.
7. Hold  to save the settings and exit.

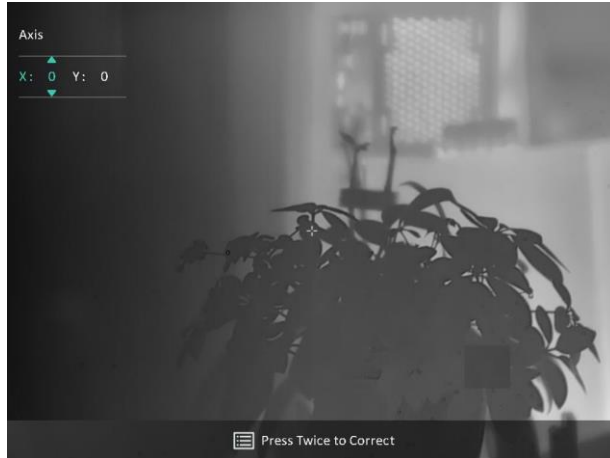

Figure 3-6 Correct Defective Pixel

Note

- The selected defective pixel can be magnified and displayed on the bottom right of the interface.
 - If the screen OSD blocks the defective pixel, move the cursor to reach the defective pixel, then the device performs mirror display automatically.
-













4 Measure Distance

The device can detect the distance between the target and the observation position.

Before You Start



When measuring the distance, keep the hand and the position steady. Otherwise, the accuracy may be affected.

Steps

1. Hold  to show the menu.
2. Go to  **Advanced Settings**, and  or  to select . Press  to enter the setting interface.
3. Set the parameters for the target.
 - 1) Press  to enter the setting interface. Press  or  to select the target from **Deer, Grey Wolf, Brown Bear, and Custom**.
 - 2) Press  to enter target height configuration interface. Press  to select digit, and press  or  to change the number.

Note

The available height ranges from 0.1 m to 9.0 m.

- 3) Hold  to save the settings and return to the distance measurement interface.
4. Align the center of top mark with the edge of target top, and press  to confirm.
5. Align the center of bottom mark with the edge of target bottom, and press  to confirm.

Result

The right top of the image displays the distance measurement result and the height of the target.













Figure 4-1 Measurement Result

5 General Settings

5.1 Set OSD

This function can display or hide the OSD information on the live view interface.

Steps

1. Hold  to show the menu.
2. Go to  **Advanced Settings**, and select  **Function Settings**.
3. Press  or  to select , and press  to enter OSD setting interface.
4. Press  or  to select the **Time, Date, or OSD**, and press  to turn on or turn off the selected OSD information.
5. Hold  to save and exit.









Note

If you turn off **OSD**, all OSD information on the live view will not be displayed.

5.2 Set Brand Logo

You can add brand logo to the live view interface, snapshots, and videos.

Steps

1. Hold  to show the menu.
2. Go to  **Advanced Settings**, and select  **Function Settings**.
3. Press  or  to select .
4. Press  to enable **Brand Logo**.
5. Hold  to save the settings and exit.

Result

The brand logo is displayed at the bottom left of the image.

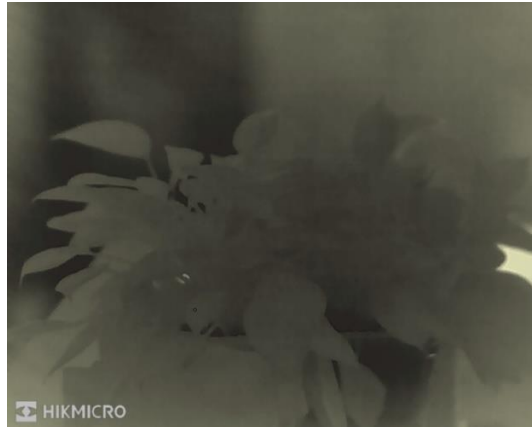









Figure 5-1 Brand Logo Display

5.3 Burning Prevention

Avoid direct sunlight and enable the burning prevention function to reduce the risk of sensor damage from the heat.

Steps

1. Hold  to show the menu.
2. Go to  **Advanced Settings**, and select  **Function Settings**.
3. Press  or  to select .
4. Press  to enable or disable the function.
5. Hold  to save settings and exit.

5.4 Capture and Video

5.4.1 Capture Picture

In the live view interface, press  to capture picture.







Note

- When capturing succeeds, the image freezes for 1 second and a prompt shows on the display.
 - For exporting pictures, refer to *Export Files*.
-

5.4.2 Set Audio

If you turn on the audio function, the sound will be recorded with the video. When there is too loud noise in the video, you can turn off this function.

Steps

1. Hold  to show the menu.
2. Go to  **Advanced Settings**, and press  or  to select .
3. Press  to enable or disable this function.
4. Hold  to save settings and exit.

5.4.3 Record Video

Steps

1. In the live view interface, hold  to start recording.

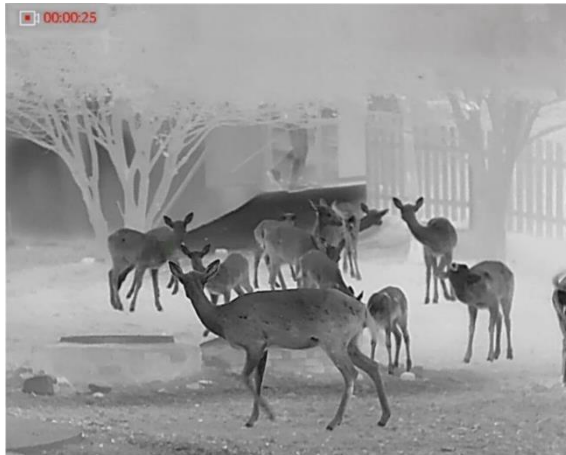



Figure 5-2 Start Recording







The left top image displays the information of recording time.

2. Hold  again to stop recording.

5.5 Hot Tracking

The device can detect the highest temperature spot in the scene and mark it on display.

Steps

1. Hold  to show the menu.
2. Go to  **Advanced Settings**, and press  or  to select .
3. Press  to mark the spot of highest temperature.

Result



When the function is enabled,  displays in the spot of highest temperature. When the scene changes, the  moves.



Figure 5-3 Hot Tracking

5.6 Export Files

5.6.1 Export Files via HIKMICRO Sight

You can access device albums and export files to your phone via HIKMICRO Sight.

Before You Start

Install HIKMICRO Sight on your mobile phone.

Steps

1. Open HIKMICRO Sight and connect your device to the app. See *App Connection*.
2. Tap **Media** to access device albums.

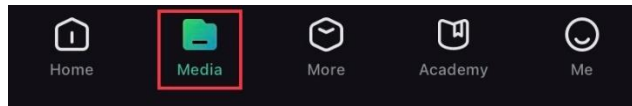

Figure 5-4 Access Device Albums

3. Tap **Local** or **Device** to view the photos and videos.
 - **Local:** You can view the files captured on app.
 - **Device:** You can view the files of the current device.

Note

The photos or videos may not show in **Device**. Please pull down to refresh the page.

4. Tap to select a file, and tap **Download** to export the file to your local phone albums.

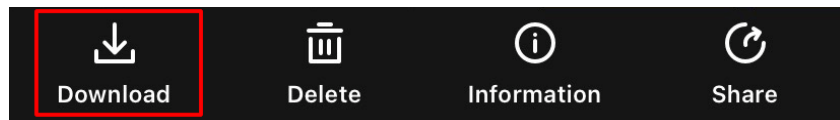

Figure 5-5 Export Files

Note

- Go to **Me** -> **About** -> **User Manual** on the app to see more detailed operations.
 - You can also access device albums by tapping bottom left icon in the live view interface.
 - The exporting operation may vary due to app updates. Please take the actual app version for reference.
-









5.6.2 Export Files via PC

This function is used to export recorded videos and captured pictures.

Before You Start

Make sure the device is turned on when connecting the cable.

Steps

1. Hold  to show the menu.
 2. Go to  **Advanced Settings**, and select  **Function Settings**.
 3. Press  or  to select , and press  to enter the configuration interface.
 4. Press  or  select **USB Flash Drive**.
 5. Connect the device and PC with cable.
-

Note

Make sure the device is turned on when connecting the cable.

6. Open computer disk and select the disk of device. Go to the DCIM folder and find the folder named after the capture year and month. For example, if you capture a picture or record a video on November 2023, go to **DCIM** -> **202311** to find the picture or video.
7. Select and copy the files to PC.
8. Disconnect the device from your PC.











 **Note**

- The device displays images when you connect it to PC. But functions such as recording, capturing and hotspot are disabled.
 - When you connect the device to PC for the first time, it installs the drive program automatically.
-

6 System Settings

















6.1 Adjust Date

Steps

1. Hold  to show the menu.
2. Go to  **Advanced Settings**, and select  **General Settings**.
3. Press  or  to select , and press  to enter the configuration interface.
4. Press  to select the year, month, or day, and press  or  to change the number.
5. Hold  to save settings and exit.

6.2 Synchronize Time











Step

1. Hold  to show the menu.
2. Go to  **Advanced Settings**, and select  **General Settings**.
3. Press  or  to select , and press  to enter the configuration interface.
4. Press  or  to switch the clock system. 24-hour and 12-hour clock are selectable. If you select 12-hour clock, press , and then press  or  to select AM or PM.
5. Press  to select the hour or minute, and Press  or  to change the number.
6. Hold  to save settings and exit.

6.3 Set Language

You can select the device language in this function.











Steps

1. Hold  to show the menu.
2. Go to  **Advanced Settings**, and select  **General Settings**.
3. Press  or  to select , and press  to enter the configuration interface.
4. Press  or  to select the language as required, and press  to confirm.
5. Hold  to save settings and exit.

6.4 Set Unit

You can switch the unit for distance measurement.

Steps

1. Hold  to show the menu.
2. Go to  **Advanced Settings**, and select  **General Settings**.
3. Press  or  to select , and press  to enter the configuration interface.
4. Press  or  to select the unit as required.
5. Hold  to save settings and exit.







6.5 CVBS Output



The CVBS output is used to debug the device. You can also view the device image on the display or handheld screen for details.

Before You Start

Connect the device and the display unit via USB to CVBS cable.

Steps

1. Hold  to show the menu.
2. Go to  **Advanced Settings**, and select  **Function Settings**.
3. Press  or  to select .
4. Press  to enter the configuration interface.









5. Press  or  select **Analog** to turn on CVBS output.
 6. Hold  to save settings and exit.
-

Note

The CVBS cable is not included in the package. Please purchase it by yourself.







6.6 View Device Information

Steps

1. Hold  to show the menu.
2. Go to  **Advanced Settings**, and select  **General Settings**.
3. Press  or  to select  , and press  to confirm. You can view the device information such as version and serial No.
4. Hold  to save settings and exit.

6.7 Restore Device

Steps

1. Hold  to show the menu.
2. Go to  **Advanced Settings**, and select  **General Settings**.
3. Press  or  to select  . Press  to restore the device to defaults according to the prompt.

7 Frequently Asked Questions

7.1 Why does the charge indicator flash improperly?

Check the following items.

- Check whether the device is charged with standard power adapter and the charging temperature is above 0 °C (32 °F).
- Charge the device in power off status.

7.2 Why is the power indicator off?

Check whether the device is off-battery. Check the indicator after charging the device for 5 minutes.

7.3 The image is not clear, how to adjust it?

Adjust the diopter adjustment ring or focus ring until the image is clear. Refer to *Adjust Diopter* or *Adjust Focus*.

7.4 Capturing or recording fails. What's the problem?

Check the following items.

- Whether the device is connected to your PC. Capturing or recording is disabled in this status.
- Whether the storage space is full.
- Whether the device is low-battery.

7.5 Why the PC cannot identify the device?

Check the following items.

- Whether the device is connected to your PC with supplied USB cable.
- If you use other USB cables, make sure the cable length is no longer than 1 m.
- Whether the USB connection mode of device is set to **USB Flash Drive**.

Legal Information

©2023 Hangzhou Microimage Software Co., Ltd. All rights reserved.

About this Manual

The Manual includes instructions for using and managing the Product. Pictures, charts, images and all other information hereinafter are for description and explanation only. The information contained in the Manual is subject to change, without notice, due to firmware updates or other reasons. Please find the latest version of this Manual at the HIKMICRO website (www.hikmicrotech.com/).

Please use this Manual with the guidance and assistance of professionals trained in supporting the Product.

Trademarks Acknowledgement



and other HIKMICRO's trademarks and logos are the properties of HIKMICRO in various jurisdictions.

Other trademarks and logos mentioned are the properties of their respective owners.

LEGAL DISCLAIMER

TO THE MAXIMUM EXTENT PERMITTED BY APPLICABLE LAW, THIS MANUAL AND THE PRODUCT DESCRIBED, WITH ITS HARDWARE, SOFTWARE AND FIRMWARE, ARE PROVIDED "AS IS" AND "WITH ALL FAULTS AND ERRORS". HIKMICRO MAKES NO WARRANTIES, EXPRESS OR IMPLIED, INCLUDING WITHOUT LIMITATION, MERCHANTABILITY, SATISFACTORY QUALITY, OR FITNESS FOR A PARTICULAR PURPOSE. THE USE OF THE PRODUCT BY YOU IS AT YOUR OWN RISK. IN NO EVENT WILL HIKMICRO BE LIABLE TO YOU FOR ANY SPECIAL, CONSEQUENTIAL, INCIDENTAL, OR INDIRECT DAMAGES, INCLUDING, AMONG OTHERS, DAMAGES FOR LOSS OF BUSINESS PROFITS, BUSINESS INTERRUPTION, OR LOSS OF DATA, CORRUPTION OF SYSTEMS, OR LOSS OF DOCUMENTATION, WHETHER BASED ON BREACH OF CONTRACT, TORT (INCLUDING NEGLIGENCE), PRODUCT LIABILITY, OR OTHERWISE, IN CONNECTION WITH THE USE OF THE PRODUCT, EVEN IF HIKMICRO HAS BEEN ADVISED OF THE POSSIBILITY OF SUCH DAMAGES OR LOSS.

YOU ACKNOWLEDGE THAT THE NATURE OF THE INTERNET PROVIDES FOR INHERENT SECURITY RISKS, AND HIKMICRO SHALL NOT TAKE ANY RESPONSIBILITIES FOR ABNORMAL OPERATION, PRIVACY LEAKAGE OR OTHER DAMAGES RESULTING FROM CYBER-ATTACK, HACKER ATTACK, VIRUS INFECTION, OR OTHER INTERNET SECURITY RISKS; HOWEVER, HIKMICRO WILL PROVIDE TIMELY TECHNICAL SUPPORT IF REQUIRED.

YOU AGREE TO USE THIS PRODUCT IN COMPLIANCE WITH ALL APPLICABLE LAWS, AND YOU ARE SOLELY RESPONSIBLE FOR ENSURING THAT YOUR USE CONFORMS TO THE APPLICABLE LAW. ESPECIALLY, YOU ARE RESPONSIBLE, FOR USING THIS PRODUCT IN A MANNER THAT DOES NOT INFRINGE ON THE RIGHTS OF THIRD PARTIES, INCLUDING WITHOUT LIMITATION, RIGHTS OF PUBLICITY, INTELLECTUAL PROPERTY RIGHTS, OR DATA PROTECTION AND OTHER PRIVACY RIGHTS. YOU SHALL NOT USE THIS PRODUCT FOR ILLEGAL HUNTING ANIMALS, INVASION OF PRIVACY OR ANY OTHER PURPOSE WHICH IS ILLEGAL OR DETRIMENTAL TO THE PUBLIC INTEREST. YOU SHALL NOT USE THIS PRODUCT FOR ANY PROHIBITED END-USES, INCLUDING THE DEVELOPMENT OR PRODUCTION OF WEAPONS OF MASS DESTRUCTION, THE DEVELOPMENT OR PRODUCTION OF CHEMICAL OR BIOLOGICAL WEAPONS, ANY ACTIVITIES IN THE CONTEXT RELATED TO ANY NUCLEAR EXPLOSIVE OR UNSAFE NUCLEAR FUEL-CYCLE, OR IN SUPPORT OF HUMAN RIGHTS ABUSES.

IN THE EVENT OF ANY CONFLICTS BETWEEN THIS MANUAL AND THE APPLICABLE LAW, THE LATTER PREVAILS.

Regulatory Information

These clauses apply only to the products bearing the corresponding mark or information.

EU Conformity Statement



This product and - if applicable - the supplied accessories too are marked with "CE" and comply therefore with the applicable harmonized European standards listed under the Directive 2014/30/EU (EMCD), Directive 2014/35/EU (LVD), Directive 2011/65/EU (RoHS), Directive 2014/53/EU.

Hereby, Hangzhou Microimage Software Co., Ltd. declares that this device (refer to the label) is in compliance with Directive 2014/53/EU.

The full text of the EU declaration of conformity is available at the following internet address:

<https://www.hikmicrotech.com/en/support/download-center/declaration-of-conformity/>

Frequency Bands and Power (for CE)

The frequency bands and transmitting power (radiated and/or conducted) nominal limits applicable to the following radio equipment are as follows:

Wi-Fi 2.4 GHz (2.4 GHz to 2.4835 GHz), 20 dBm

For the device without a supplied power adapter, use the power adapter provided by a qualified manufacturer. Refer to the product specification for detailed power requirements.

For the device without a supplied battery, use the battery provided by a qualified manufacturer. Refer to the product specification for detailed battery requirements.



Directive 2012/19/EU (WEEE Directive): Products marked with this symbol cannot be disposed of as unsorted municipal waste in the European Union. For proper recycling, return this product to your local supplier upon the purchase of equivalent new equipment, or dispose of it at designated collection points. For more information see: www.recyclethis.info



Directive 2006/66/EC and its amendment 2013/56/EU (Battery Directive): This product contains a battery that cannot be disposed of as unsorted municipal waste in the European Union. See the product documentation for specific battery information. The battery is marked with this symbol, which may include lettering to indicate cadmium (Cd), lead (Pb), or mercury (Hg). For proper recycling, return the battery to your supplier or to a designated collection point. For more information see: www.recyclethis.info.

KC

B 급 기기: 이 기기는 가정용(B 급) 전자파적합기기로서 주로 가정에서 사용하는 것을 목적으로 하며, 모든 지역에서 사용할 수 있습니다.

INFORMATIONEN FÜR PRIVATE HAUSHALTE

1. Getrennte Erfassung von Altgeräten:

Elektro- und Elektronikgeräte, die zu Abfall geworden sind, werden als Altgeräte bezeichnet. Besitzer von Altgeräten haben diese einer vom unsortierten Siedlungsabfall getrennten Erfassung zuzuführen. Altgeräte gehören insbesondere nicht in den Hausmüll, sondern in spezielle Sammel- und Rückgabesysteme.

2. Batterien und Akkus sowie Lampen:

Besitzer von Altgeräten haben Altbatterien und Altakkumulatoren, die nicht vom Altgerät umschlossen sind, die zerstörungsfrei aus dem Altgerät entnommen werden können, im Regelfall vor der Abgabe an einer Erfassungsstelle vom Altgerät zu trennen. Dies gilt nicht, soweit Altgeräte einer Vorbereitung zur Wiederverwendung unter Beteiligung eines öffentlich-rechtlichen Entsorgungsträgers zugeführt werden.

3. Möglichkeiten der Rückgabe von Altgeräten:

Besitzer von Altgeräten aus privaten Haushalten können diese bei den Sammelstellen der öffentlich-rechtlichen Entsorgungsträger oder bei den von Herstellern oder Vertreibern im Sinne des ElektroG eingerichteten

Rücknahmestellen unentgeltlich abgeben. Rücknahmepflichtig sind Geschäfte mit einer Verkaufsfläche von mindestens 400 m² für Elektro- und Elektronikgeräte sowie diejenigen Lebensmittelgeschäfte mit einer Gesamtverkaufsfläche von mindestens 800 m², die mehrmals pro Jahr oder dauerhaft Elektro- und Elektronikgeräte anbieten und auf dem Markt bereitstellen. Dies gilt auch bei Vertrieb unter Verwendung von Fernkommunikationsmitteln, wenn die Lager- und Versandflächen für Elektro- und Elektronikgeräte mindestens 400 m² betragen oder die gesamten Lager- und Versandflächen mindestens 800 m² betragen. Vertreiber haben die Rücknahme grundsätzlich durch geeignete Rückgabemöglichkeiten in zumutbarer Entfernung zum jeweiligen Endnutzer zu gewährleisten. Die Möglichkeit der unentgeltlichen Rückgabe eines Altgerätes besteht bei rücknahmepflichtigen Vertreibern unter anderem dann, wenn ein neues gleichartiges Gerät, das im Wesentlichen die gleichen Funktionen erfüllt, an einen Endnutzer abgegeben wird.

4. Datenschutz-Hinweis:

Altgeräte enthalten häufig sensible personenbezogene Daten. Dies gilt insbesondere für Geräte der Informations- und Telekommunikationstechnik wie Computer und Smartphones. Bitte beachten Sie in Ihrem eigenen Interesse, dass für die Löschung der Daten auf den zu entsorgenden Altgeräten jeder Endnutzer selbst verantwortlich ist.



5. Bedeutung des Symbols „durchgestrichene Mülltonne“:



Das auf Elektro- und Elektronikgeräten regelmäßig abgebildete Symbol einer durchgestrichenen Mülltonne weist darauf hin, dass das jeweilige Gerät am Ende seiner Lebensdauer getrennt vom unsortierten Siedlungsabfall zu erfassen ist.

Symbol Conventions

The symbols that may be found in this document are defined as follows.

Symbol	Description
 Note	Provides additional information to emphasize or supplement important points of the main text.
 Caution	Indicates a potentially hazardous situation, which if not avoided, could result in equipment damage, data loss, performance degradation, or unexpected results.
 Danger	Indicates a hazard with a high level of risk, which if not avoided, will result in death or serious injury.

Safety Instruction

These instructions are intended to ensure that user can use the product correctly to avoid danger or property loss. Please read all the safety information carefully before using.

Transportation

- Keep the device in original or similar packaging while transporting it.
- Keep all wrappers after unpacking them for future use. In case of any failure occurred, you need to return the device to the factory with the original wrapper. Transportation without the original wrapper may result in damage on the device and the company shall not take any responsibilities.
- Do not drop the product or subject it to physical shock. Keep the device away from magnetic interference.

Power Supply

- The input voltage for the device should meet the Limited Power Source (5 VDC, 2 A) according to the IEC62368-1 standard. Please refer to actual products and technical specifications for detailed information.
- Make sure the plug is properly connected to the power socket.
- DO NOT connect multiple devices to one power adapter, to avoid overheating or fire hazards caused by overload.
- The power source should meet limited power source or PS2 requirements according to IEC 62368-1 standard.

Battery

- The external rechargeable battery type is 18650, and the battery size should be 19 mm × 70 mm. The rated voltage is 3.6 VDC, and the battery capacity is 3200 mAh.
- For long-term storage of the battery, make sure it is fully charged every half year to ensure the battery quality. Otherwise, damage may occur.
- CAUTION: Risk of explosion if the battery is replaced by an incorrect type.
- Improper replacement of the battery with an incorrect type may defeat a safeguard (for example, in the case of some lithium battery types).
- Do not dispose of the battery into fire or a hot oven, or mechanically crush or cut the battery, which may result in an explosion.
- Do not leave the battery in an extremely high temperature surrounding

environment, which may result in an explosion or the leakage of flammable liquid or gas.

- Do not subject the battery to extremely low air pressure, which may result in an explosion or the leakage of flammable liquid or gas.
- Dispose of used batteries according to the instructions.
- Confirm there is no flammable material within 2 m of the charger during charging.
- DO NOT place the battery in the reach of children.
- DO NOT swallow the battery to avoid chemical burns.

Maintenance

- If the product does not work properly, please contact your dealer or the nearest service center. We shall not assume any responsibility for problems caused by unauthorized repair or maintenance.
- Wipe the device gently with a clean cloth and a small quantity of ethanol, if necessary.
- If the equipment is used in a manner not specified by the manufacturer, the protection provided by the device may be impaired.
- Clean the lens with soft and dry cloth or wiping paper to avoid scratching it.

Using Environment

- Make sure the running environment meets the requirement of the device. The operating temperature shall be -30 °C to 55 °C (-22 °F to 131 °F), and the operating humidity shall be from 5% to 95%.
- DO NOT expose the device to high electromagnetic radiation or dusty environments.
- DO NOT aim the lens at the sun or any other bright light.
- Place the device in a dry and well-ventilated environment.
- Avoid equipment installation on vibratory surface or places subject to shock (neglect may cause equipment damage).

Emergency

If smoke, odor, or noise arises from the device, immediately turn off the power, unplug the power cable, and contact the service center.

Manufacture Address

Room 313, Unit B, Building 2, 399 Danfeng Road, Xixing Subdistrict, Binjiang District, Hangzhou, Zhejiang 310052, China

Thermal Monocular User Manual

Hangzhou Microimage Software Co., Ltd.

COMPLIANCE NOTICE: The thermal series products might be subject to export controls in various countries or regions, including without limitation, the United States, European Union, United Kingdom and/or other member countries of the Wassenaar Arrangement. Please consult your professional legal or compliance expert or local government authorities for any necessary export license requirements if you intend to transfer, export, re-export the thermal series products between different countries.



HIKMICRO

See the World in a New Way



Facebook: HIKMICRO Outdoor Instagram: hikmicro_outdoor

YouTube: HIKMICRO Outdoor

LinkedIn: HIKMICRO

Web: www.hikmicrotech.com

E-mail: support@hikmicrotech.com

UD35841B