



# Thermal Monocular THUNDER & THUNDER Pro Series

User Manual V5.5.54 202212



Contact Us

## Table of Contents

<b>Chapter 1 Overview</b> .....	<b>1</b>
<b>1.1 Device Description</b> .....	<b>1</b>
<b>1.2 Main Function</b> .....	<b>1</b>
<b>1.3 Appearance</b> .....	<b>1</b>
<b>1.3.1 Component</b> .....	<b>1</b>
<b>1.3.2 Button</b> .....	<b>3</b>
<b>Chapter 2 Preparation</b> .....	<b>4</b>
<b>2.1 Connect Device</b> .....	<b>4</b>
<b>2.2 Install Battery</b> .....	<b>4</b>
<b>2.2.1 Battery Instruction</b> .....	<b>4</b>
<b>2.2.2 Battery Installation</b> .....	<b>5</b>
<b>2.2.3 Select Battery Type</b> .....	<b>5</b>
<b>2.3 Install Adapter</b> .....	<b>6</b>
<b>2.4 Remove Adapter</b> .....	<b>6</b>
<b>2.5 Power On/Off</b> .....	<b>6</b>
<b>2.6 Menu Description</b> .....	<b>7</b>
<b>2.7 Client Software Connection</b> .....	<b>8</b>
<b>2.8 Firmware Status</b> .....	<b>8</b>
<b>2.8.1 Check Firmware Status</b> .....	<b>8</b>
<b>2.8.2 Upgrade Device</b> .....	<b>9</b>
<b>2.9 Calibrate Image</b> .....	<b>10</b>
<b>Chapter 3 Image Settings</b> .....	<b>11</b>
<b>3.1 Adjust Focus</b> .....	<b>11</b>
<b>3.2 Adjust Brightness</b> .....	<b>11</b>
<b>3.3 Adjust Contrast</b> .....	<b>11</b>
<b>3.4 Select Scene</b> .....	<b>11</b>
<b>3.5 Set Palettes</b> .....	<b>12</b>
<b>3.6 Correct Defective Pixel</b> .....	<b>13</b>
<b>3.7 Flat Field Correction</b> .....	<b>14</b>
<b>3.8 Calibrate Image</b> .....	<b>14</b>

<b>Chapter 4 Measure Distance</b> .....	<b>16</b>
<b>Chapter 5 General Settings</b> .....	<b>17</b>
<b>5.1 Set OSD</b> .....	<b>17</b>
<b>5.2 Set Brand Logo</b> .....	<b>17</b>
<b>5.3 Burning Prevention</b> .....	<b>18</b>
<b>5.4 Capture and Video</b> .....	<b>18</b>
<b>5.4.1 Capture Picture</b> .....	<b>18</b>
<b>5.4.2 Record Video</b> .....	<b>18</b>
<b>5.5 Hot Tracking</b> .....	<b>19</b>
<b>5.6 Export Files</b> .....	<b>20</b>
<b>5.6.1 Export Files via HIKMICRO Sight</b> .....	<b>20</b>
<b>5.6.2 Export Files via PC</b> .....	<b>21</b>
<b>Chapter 6 System Settings</b> .....	<b>22</b>
<b>6.1 Synchronize Time</b> .....	<b>22</b>
<b>6.2 Language Settings</b> .....	<b>22</b>
<b>6.3 Unit Settings</b> .....	<b>22</b>
<b>6.4 CVBS Output</b> .....	<b>22</b>
<b>6.5 View Device Information</b> .....	<b>23</b>
<b>6.6 Restore Device</b> .....	<b>23</b>
<b>Chapter 7 Frequently Asked Questions</b> .....	<b>24</b>
<b>7.1 Why is the monitor off?</b> .....	<b>24</b>
<b>7.2 The image is not clear, how to adjust it?</b> .....	<b>24</b>
<b>7.3 Capturing or recording fails. What's the problem?</b> .....	<b>24</b>
<b>7.4 Why the PC cannot identify the device?</b> .....	<b>24</b>
<b>Safety Instruction</b> .....	<b>25</b>
<b>Legal Information</b> .....	<b>27</b>
<b>Regulatory Information</b> .....	<b>29</b>

# Chapter 1 Overview

## 1.1 Device Description

The thermal monocular THUNDER and THUNDER Pro provide clear images under harsh environmental conditions like darkness, fog, smoke, dust, rain, snow, wood, camouflage, etc. They are mainly applied to scenarios such as patrolling and hunting.

## 1.2 Main Function

- Distance Measurement: The device can detect the distance between the target and the device.
- Hot Tracking: The device can detect the highest temperature in the scene and mark the spot.
- Client Software Connection: The device can capture snapshots, record videos, and set parameters by HIKMICRO Sight App after being connected to your phone via hotspot.
- Image Correction: The device supports DPC (Defective Pixel Correction) and FFC (Flat Field Correction) which can optimize the image quality.
- Image Calibration: You can adjust the image window position as required. See **Calibrate Image**.

## 1.3 Appearance

There are two types of thermal monocular cameras. Please take the actual product for reference.

### 1.3.1 Component

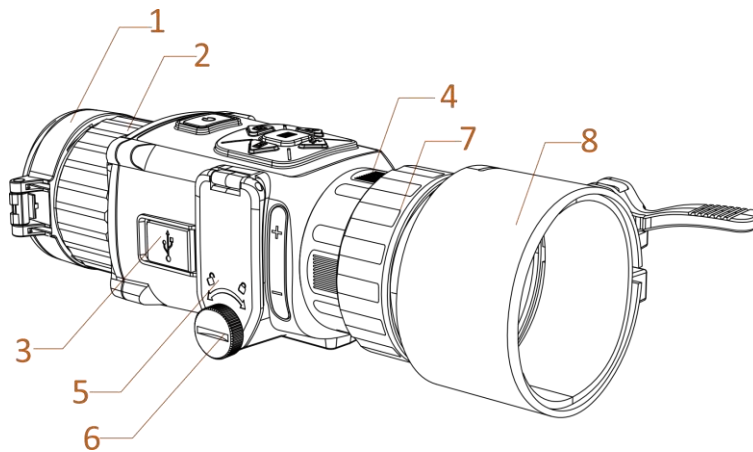

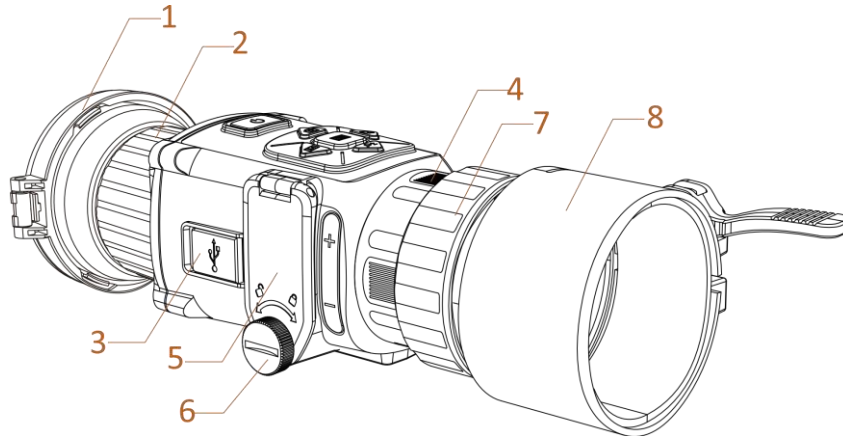

**Figure 1-1 Components of Thermal Telescope**

**Table 1-1 Component Description**

No	Component	Function
1	Lens Cover	Protects the lens.
2	Focus Ring	Adjusts focus to obtain clear targets.
3	Type-C Interface	To connect the device to power supply or transmit data with a type-C cable.
4	Fixing Ring	Holds the eyepiece in place.
5	Battery Compartment	For holding the battery.
6	Bolt	Loosens the bolt to install the batteries.
7	Locking Ring	Locks the adapter with the device.
8	Adapter	Connects to optical lens.

---

 **Note**

- The adapter is not included in the package. Please purchase separately if necessary.
  - Four diameters of adapters are selectable: 38 mm, 40 mm, 50 mm, and 62 mm.
-

### 1.3.2 Button

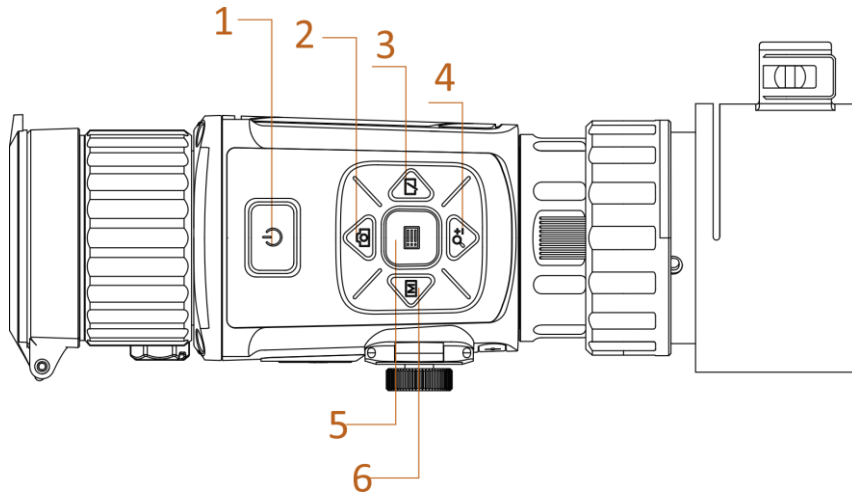

Figure 1-2 Buttons on Device

Table 1-2 Function of Buttons

No	Icon	Button	Description
1		Power	<ul style="list-style-type: none"> <li>● Press: Standby mode/wake up device</li> <li>● Hold: Power on/off</li> </ul>
2		Capture	<ul style="list-style-type: none"> <li>● Press: Capture</li> <li>● Hold: Start/stop record video</li> </ul>
3		Shutter	Press: Correct non-uniformity of display
4		Zoom	Press: Move the cursor down in the menu mode.
5		Menu	<ul style="list-style-type: none"> <li>● Press: Enable/disable OSD</li> <li>● Hold: Menu operation</li> </ul>
6		Mode	Press: Switch palettes
2 + 4		Capture + Zoom	Press: Enter image calibration mode

## Chapter 2 Preparation

### 2.1 Connect Device

#### Before You Start

- Remove batteries from the device before connecting to your PC, or it may cause device damage.
- Turn on the device after connecting it to your PC, and keep the device on for 10 to 15 seconds before other operations.

#### Steps

1. Turn on the device and make sure the hotspot function is disabled.
2. Lift the cable interface cover.
3. Connect the device and power adapter with a type-C cable to power on the device.  
Alternatively, connect the device and PC to export files.

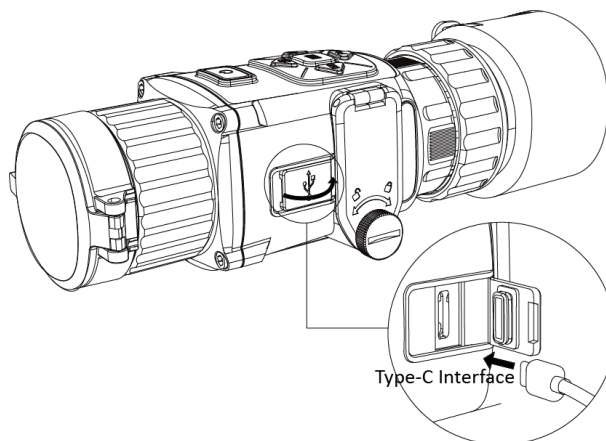

Figure 2-1 Cable Interface

### 2.2 Install Battery

#### 2.2.1 Battery Instruction

- The device supports 3.0 V or 3.7 V rechargeable lithium battery or 3.0 V non-rechargeable dry battery.
- The batteries in the package cannot be charged.
- Select the correct battery voltage in the device menu after you install the battery, or it may cause abnormal shutdown.
- If you are using rechargeable batteries, charge them for more than 4 hours before first use.

- The external removable battery type is CR123A. The max. rated voltage is 3 VDC/2 A, and the battery capacity is 1600 mAh.

### 2.2.2 Battery Installation

Insert the batteries into the battery compartment.

#### Steps

1. Rotate the bolt anticlockwise to loosen it.

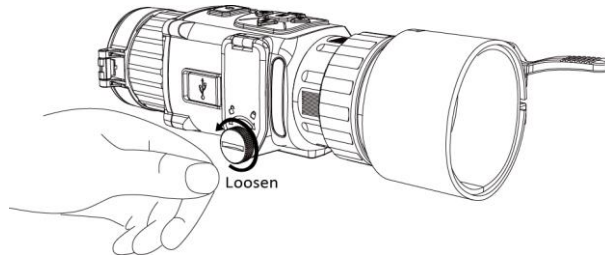

**Figure 2-2 Loosen Hand Screw**

2. Make sure the battery's positive terminal and negative terminal are installed correctly.

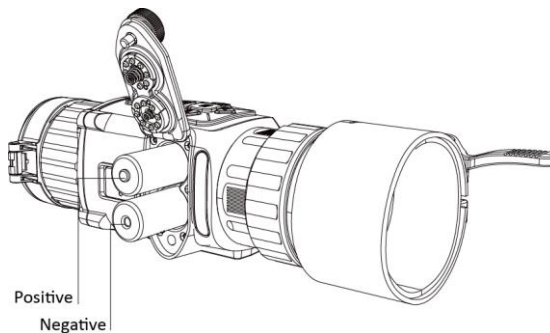

**Figure 2-3 Install Batteries**

3. Rotate the bolt clockwise to tighten it.

Take the battery away if the device is not used for a long time.

### 2.2.3 Select Battery Type

The device supports multiple types of batteries and you can change the battery type according to your need. Select the battery voltage according to the actual situation, so that the device can display the remaining power correctly.

#### Steps

1. In the view mode, hold  to show the menu.
2. Select , and press  to switch the voltage.



## 2.3 Install Adapter

### Steps

1. Make sure the red dot of the adapter align with the red dot of the eyepiece, and insert the adapter as arrow 1.
2. Rotate the locking ring anticlockwise (as arrow 2 shows).

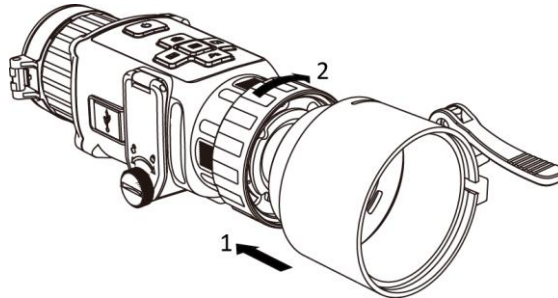

Figure 2-4 Install Adapter

---

### Note

- The adapter is not included in the package. Please purchase separately if necessary.
  - Four diameters of adapters are selectable: 38 mm, 40 mm, 50 mm, and 62 mm.
- 

## 2.4 Remove Adapter

### Steps

1. Rotate only the locking ring clockwise, and make sure the device or other parts of the adapter are not rotated or moved.
2. Plug out the adapter after it is loosen.

## 2.5 Power On/Off

### Power On

When the battery is sufficiently charged, hold  for about 2 seconds to power on the device.

### Power Off

When the device is turned on, hold  for about 2 seconds to power off the device.

---

### Note

- Power-off countdown will appear when you power off the device. You can press any key to interrupt the countdown and cancel the power-off.
  - Automatic low battery power-off cannot be canceled.
-

## Auto Power Off



Set the auto power off time for your device, and then the device will automatically shut down as the set time.

### Steps

1. Hold  to go to the menu.
2. Press  or  to select , and press  to select the auto power off time as required.
3. Hold  to save and exit.





---

### Note

- See the battery icon for the battery status.  means the battery is fully charged, and  means that the battery is low.
  - When the low power note shows, charge the battery.
  - The auto power off countdown will start again when the device exits standby mode, or the device is restarted.
- 

## 2.6 Menu Description

When the device is turned on, press  to display the OSD menu.

- Press  to move the cursor up.
- Press  to move the cursor down.
- Press  to move the cursor left.
- Press  to move the cursor right.
- Press  to confirm.

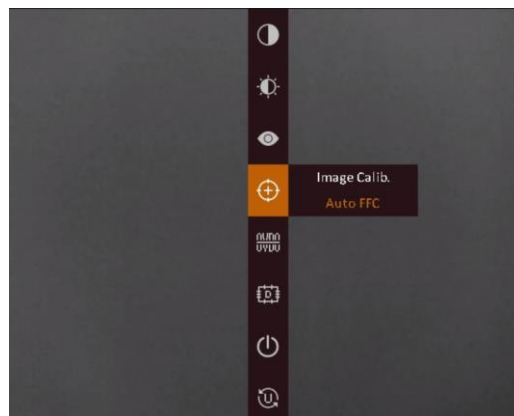

Figure 2-5 Menu Interface

## 2.7 Client Software Connection

Connect the device to the HIKMICRO Sight App via hotspot, then you can capture picture, record video, or configure parameters on your phone.

### Steps



1. Search the HIKMICRO Sight App on App Store (iOS System) or Google Play™ (Android System) to download it, or scan the QR code to download and install the app.



Android System



iOS System

2. Hold  to show the menu of device.
3. Press  to enable hotspot function.
4. Turn on the WLAN of your phone and connect to the hotspot.
  - Hotspot Name: HIK-IPTS Serial No.
  - Hotspot Password: the last 9 numbers of serial No.
5. Open the App and connect your phone with the device. You can view the interface of device on your phone.

---

### Note

- The device cannot connect to the app if entering wrong password several times. Refer to **Restore Device** to reset the device, and connect the app again.
  - The device should be activated for the first use. The default password must be changed after the activation.
- 

## 2.8 Firmware Status

### 2.8.1 Check Firmware Status

#### Steps

1. Open the HIKMICRO Sight and connect your device to the app.
2. Check if there is a red spot on the connection interface. If there is no red spot, the firmware is the latest version. Otherwise, the firmware is not the latest version.

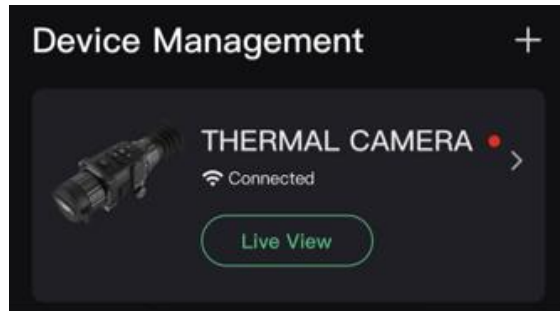

Figure 2-6 Check Firmware Status

3. (Optional) If the firmware is not the latest version, upgrade the device. See *Upgrade Device*.

## 2.8.2 Upgrade Device

### Upgrade Device via HIKMICRO Sight

#### Before You Start

Install HIKMICRO Sight on your phone and connect your device to the app.

#### Steps

1. Tap the device series to enter the device information interface.
2. Tap **Device Upgrade** to enter the firmware upgrade interface.
3. Tap **Update** to start upgrade.

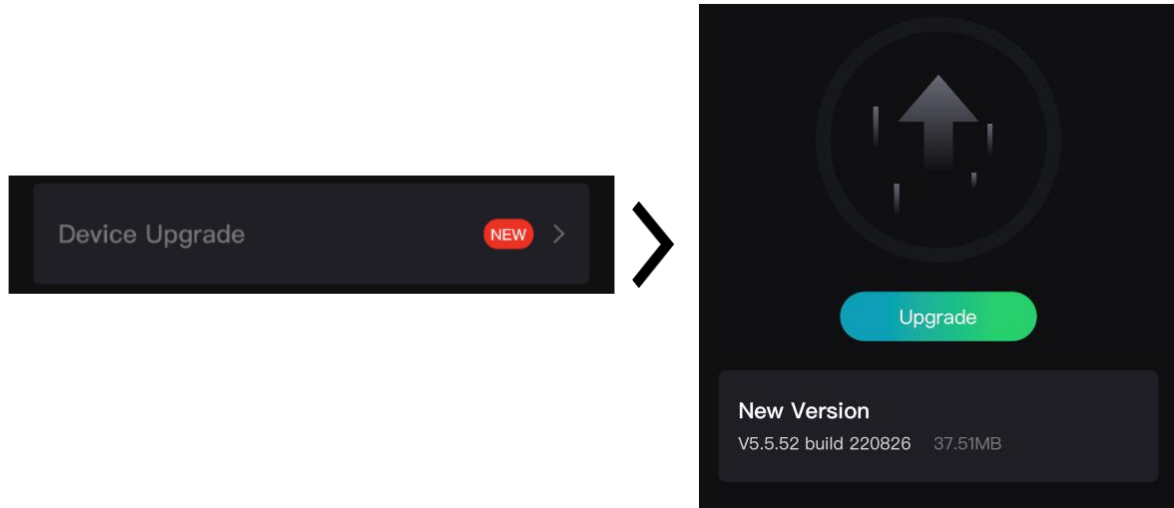

Figure 2-7 Upgrade Firmware

### Upgrade Device via PC

#### Before You Start

- Please get the upgrade package (including Main Firmware and FPGA Firmware) first.

- Make sure the hotspot function is disabled.
- Remove batteries from the device before connecting to your PC.
- Turn on the device after connecting it to your PC, and keep the device on for 10 to 15 seconds before other operations.

### Steps

1. Connect the device to your PC with cable, and then turn on the device.
2. Open the detected disk, copy the upgrade file and paste it to the root directory of the device.
3. Hold  to reboot the device, and the device upgrades automatically. The upgrading process will be displayed in the main interface.

---

### Note

During the upgrade, make sure the device is connected to your PC. Otherwise, it may cause unnecessary upgrade failure, firmware damage, etc.

---

4. Repeat the above steps to upgrade all firmware one by one.

## 2.9 Calibrate Image

You can adjust and save the position of the image window for different users. See *Calibrate Image* for detailed instructions.



Figure 2-8 Image Calibration Effect

## Chapter 3 Image Settings

### 3.1 Adjust Focus

#### Steps

1. Power on the device.
2. Open the lens cover.
3. Hold the device and make sure the eyepiece covers your eye.
4. Adjust the focus ring until the image is clear.

---

#### Note

When adjusting focus, DO NOT touch the surface of lens to avoid smearing the lens.

---

### 3.2 Adjust Brightness





In the menu mode, select  and press  to adjust brightness. In white hot mode, the higher the value of brightness is, the brighter the image is. The image effect in white hot mode is showed as picture below and effect in black hot mode is opposite.



Figure 3-1 Adjust Brightness in White Hot Mode



### 3.3 Adjust Contrast



In the menu mode, select  and press  to adjust image contrast.

### 3.4 Select Scene

You can select proper scene according to actual using scene to improve the display effect.

#### Steps

1. Hold  to go to the menu.
2. Select  and press  to switch scene.

-  refers to recognition mode and is recommended in normal scene.
-  refers to jungle mode and is recommended in hunting environment.

3. Hold  to save settings and exit.

### 3.5 Set Palettes

You can select different palettes to display the same scene in different effects. Press  to switch palettes.

#### White Hot

The hot part is light-colored in view. The higher the temperature is, the lighter the color is.



#### Black Hot

The hot part is black-colored in view. The higher the temperature is, the darker the color is.



#### Red Hot

The hot part is red-colored in view. The higher the temperature is, the redder the color is.



### Fusion







From high temperature to low temperature, the image is colored in from white, yellow, red, pink to purple.



## 3.6 Correct Defective Pixel

The device can correct the defective pixels on the screen which are not performed as expected.

### Steps

1. Hold  to show the menu.
2. Select .
3. Press , , , and  to move the cursor to the position of dead pixel.
4. Press  to correct the dead pixel.



 **Note**

The selected defective pixel can be magnified and displayed at the bottom right of the interface.









**Figure 3-2 Correct Defective Pixel**

---

### 3.7 Flat Field Correction

This function can correct non-uniformity of display.















#### Steps

1. Hold  to go to the menu.
2. Select  and press  to switch FFC mode.
  - Manual: Hold  in live view to trigger calibration.
  - Auto: The device performs FFC automatically according to the set schedule when switching on the camera.
  - External: Cover the lens cover, then hold  in live view to trigger calibration.
3. Hold  to save the settings and exit.

### 3.8 Calibrate Image



You can adjust and save the position of the image window for different users.

#### Steps

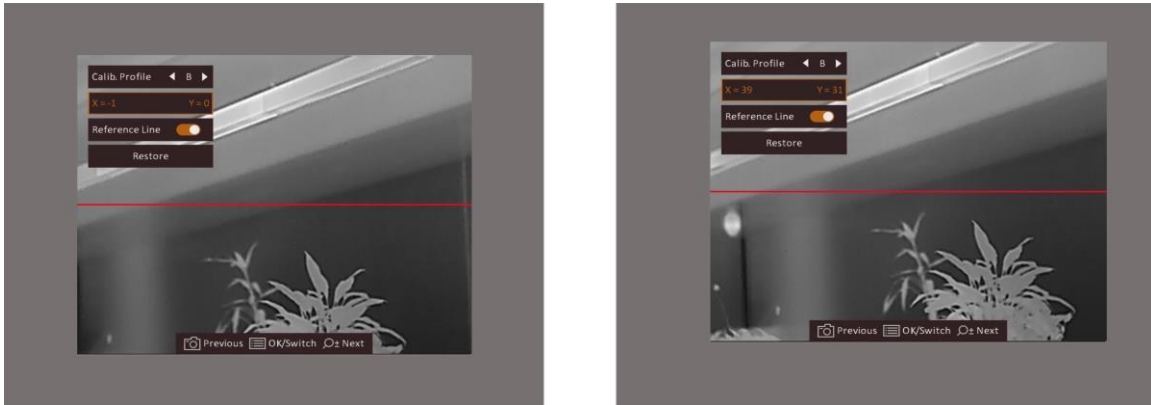
1. Hold  and  simultaneously to enter the image calibration interface.
2. Press  or  to select **Calib. Profile**, and press  to switch the profile No.
3. (Optional) Press  or  to select **Reference Line**, and press  to enable or disable it. A horizontal reference line appears in the middle of the view when it is enabled.
4. Press  or  to select the coordinates, and press  to confirm.
5. Press  or  to adjust the **X** axis, and  or  to adjust the **Y** axis until the image window reaches the required position.



**Figure 3-3 Actual Image Calibration Effect**

6. (Optional) Press  or  to select **Restore**, and press  to confirm. Press **OK** to restore the view to default position, and **CANCEL** to return to the setting interface according to the prompt.

---

 **Note**

The default position of image window may not be exactly at zero ( $X = 0$ ,  $Y = 0$ ). This is caused by slight individual differences of optical components, and it is a normal phenomenon.

---

7. Hold  to exit image calibration.





## Chapter 4 Measure Distance

The device can detect the distance between the target and the observation position.

### Before You Start

When measuring the distance, keep the hand and the position steady. Otherwise, the accuracy may be affected.

### Steps



1. Hold  to show the menu.
2. Select  and press  to go to the setting interface.
  - 1) Press  or  to select the target from **Deer**, **Grey Wolf**, **Brown Bear**, and **Custom**.
  - 2) Set the target height.

---

### Note

The available height ranges from 0.1 m to 9.9 m.

---

- 3) Press  to confirm.
3. Align the center of top mark with the edge of target top. Press .  
The cursor blinks on the top edge of the target.
4. Align the center of bottom mark with the edge of target bottom. Press .

### Result

The left top of the image displays the distance measurement result and the height of the target.



Figure 5-1 Measurement Result

---

### Note

Go to distance measurement interface, and press  to view the result of the previous measuring target.

---







## Chapter 5 General Settings

You can manually record video or capture picture when displaying live view.

### 5.1 Set OSD

You can choose whether to display the OSD information on the live view interface.

#### Steps

1. Hold  to show the menu.
2. Select , and press  to enter the OSD setting interface.
3. Press  and  to select the OSD information you want to display or not, and press  again to confirm.
4. Hold  to save and exit.

---

#### Note







You can also press  in the live view mode to display or hide all the OSD information quickly.

---

### 5.2 Set Brand Logo

You can add brand logo on the live view interface.

#### Steps

1. Hold  to show the menu.
2. Press  or  to select .
3. Press  to enable **Brand Logo**.
4. Hold  to save the settings and exit.

#### Result

The brand logo is displayed at the bottom right of the image.



Figure 5-1 Brand Logo Display

---

 **Note**





After enabling this function, the brand logo only displays on the live view interface, captures and videos.

---

## 5.3 Burning Prevention

This function can prevent the detector of the thermal channel from being burned. When you enable this function, the shield will close if the grey scale of the detector reaches a certain value.

### Steps

1. Hold  to show the menu.
  2. Select  and press  to enable or disable the burn-prevention function.
  3. Hold  to save settings and exit.
- 

 **Note**

Avoid direct sunlight and enable the Burning Prevention function to reduce the risk of sensor damage from the heat.

---

## 5.4 Capture and Video

### 5.4.1 Capture Picture

On the main live view page, press  to capture picture.

---

 **Note**

When capturing succeeds, the image freezes for 1 second and a prompt shows on the display. For exporting captured pictures, refer to ***Export Files***.

---

### 5.4.2 Record Video

#### Steps

1. In the main live view, hold  and start recording.



**Figure 5-2 Start Recording**

The left top of image displays the information of recording time.

2. Hold  again to stop recording.





### What to do next

For exporting recording files, refer to *Export Files*.



## 5.5 Hot Tracking

The device can detect the highest temperature spot in the scene and mark it on display.

### Steps

1. Hold  to show the menu.
2. Select  and press  to mark the spot of highest temperature.
3. Hold  to save settings and exit.

### Result

When the function is enabled,  displays in the spot of highest temperature. When the scene changes, the  moves.



**Figure 5-3 Hot Tracking Effect**

## 5.6 Export Files

This function is used to export recorded videos and captured pictures.

### 5.6.1 Export Files via HIKMICRO Sight

You can access device albums and export files to your phone via HIKMICRO Sight.

#### Before You Start

Install HIKMICRO Sight on your mobile phone.

#### Steps

1. Open HIKMICRO Sight and connect your device to the app. See *Client Software Connection*.
2. Tap **Media** to access device albums.

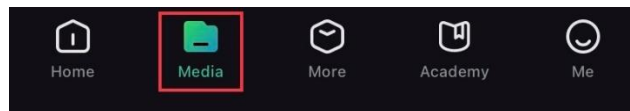

Figure 5-4 Access Device Albums

3. Tap **Local** or **Device** to view the photos and videos.
  - **Local**: You can view the previous files on the app.
  - **Device**: You can view the files of the current device.

---

#### Note

The photos or videos may not show in **Device**. Please pull down to refresh the page.

---

4. Tap to select a file, and tap **Download** to export the file to your local phone albums.

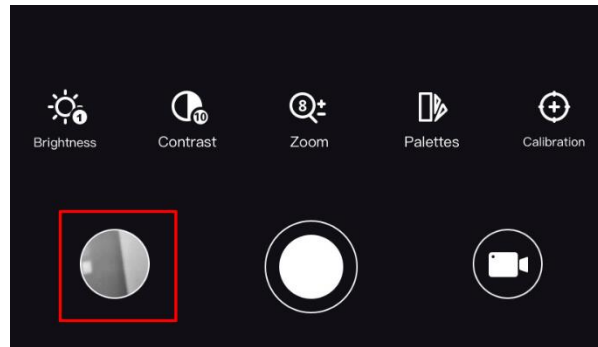

Figure 5-5 Export Files

---

#### Note

- Go to **Me** → **About** → **User Manual** on the app to see more detailed operations.
- You can also access device albums by tapping bottom left icon in the live view interface.



**Figure 5-6 Access Device Albums**

- The exporting operation may vary due to app updates. Please take the actual app version for reference.
- 

### 5.6.2 Export Files via PC

#### Before You Start

- Turn off hotspot function.
- Turn on the device after connecting it to your PC, and keep the device on for 10 to 15 seconds before other operations.
- Remove batteries from the device before connecting to your PC, or it may cause device damage.

#### Steps

1. Connect the device and PC with cable.
- 

#### Note

Make sure the device is turned on when connecting the cable.

---

2. Open computer disk and select the disk of device. Go to the **DCIM** folder and find the folder named after the capture year and month. For example, if you capture a picture or record a video on June 2021, go to **DCIM → 202106** to find the picture or video.
  3. Select and copy the files to PC.
  4. Disconnect the device from your PC.
- 

#### Note











- The device displays images when you connect it to PC. But functions such as recording, capturing and hotspot are disabled.
  - When you connect the device to PC for the first time, it installs the drive program automatically.
  - You can also export files via HIKMICRO Sight. See the user manual of the app for detailed operation.
-



## Chapter 6 System Settings

### 6.1 Synchronize Time







#### Steps

1. Hold  to show the menu.
2. Select , and press  to enter the time setting interface.
3. Press  to switch the time system, and press  and  to select the time and date to be synchronized.
4. Press  to select the hour, minute, second, year, month, or day to be synchronized, and press  and  again to change the number.
5. Hold  to save settings and exit.

### 6.2 Language Settings

You can select the device language in this function.

#### Steps

1. Hold  to show the menu.
2. Select , and press  to enter the language configuration interface.
3. Press  or  to select the language as required, and press  to confirm.

### 6.3 Unit Settings

You can switch the unit for fusion level and laser ranging functions.

#### Steps

1. Hold  to show the menu.
2. Press  or  to select , and press  to switch the unit. **Yard** and **m** (meter) are selectable.
3. Hold  to save settings and exit.



### 6.4 CVBS Output

The CVBS output is used to debug the device. You can also view the device image on the display unit for details.

#### Before You Start

Connect the device to the display unit via CVBS interface of the aviation plug.

### Steps

1. Hold  to show the menu.
2. Select , and press  to switch on CVBS.

---



### Note

The CVBS cable is not included in the package. Please purchase it by yourself.

---



## 6.5 View Device Information

### Steps

1. Hold  to show the menu of device.
2. Select , and press . You can view the device information such as version, and serial No.

## 6.6 Restore Device

### Steps

1. Hold  to show the menu of device.
2. Select , and press  to restore the device to defaults according to the prompt.

## Chapter 7 Frequently Asked Questions

### 7.1 Why is the monitor off?

Check whether the device is off-battery. Check the monitor after charging the device for 5 minutes.

### 7.2 The image is not clear, how to adjust it?

Adjust the focus ring until the image is clear. Refer to *Adjust Focus*.

### 7.3 Capturing or recording fails. What's the problem?

Check the following items.

- Whether the device is connected to your PC. Capturing or recording is disabled in this status.
- Whether the storage space is full.
- Whether the device is low-battery.

### 7.4 Why the PC cannot identify the device?

Check the following items.

- Whether the device is connected to your PC with supplied USB cable.
- If you use other USB cables, make sure the cable length is no longer than 1 m.

## Safety Instruction



These instructions are intended to ensure that user can use the product correctly to avoid danger or property loss.

### Laws and Regulations

- Use of the product must be in strict compliance with the local electrical safety regulations.

### Symbol Conventions

The symbols that may be found in this document are defined as follows.

Symbol	Description
 <b>Danger</b>	Indicates a hazardous situation which, if not avoided, will or could result in death or serious injury.
 <b>Caution</b>	Indicates a potentially hazardous situation which, if not avoided, could result in equipment damage, data loss, performance degradation, or unexpected results.
 <b>Note</b>	Provides additional information to emphasize or supplement important points of the main text.

### Transportation

- Keep the device in original or similar packaging while transporting it.
- Keep all wrappers after unpacking them for future use. In case of any failure occurred, you need to return the device to the factory with the original wrapper. Transportation without the original wrapper may result in damage on the device and the company shall not take any responsibilities.
- DO NOT drop the product or subject it to physical shock. Keep the device away from magnetic interference.

### Power Supply

- Please purchase the charger by yourself. Input voltage should meet the Limited Power Source (5 VDC, 2A) according to the IEC62368 standard. Please refer to technical specifications for detailed information.
- Use the power adapter provided by qualified manufacturer. Refer to the product specification for detailed power requirements.
- Make sure the plug is properly connected to the power socket.
- DO NOT connect multiple devices to one power adapter, to avoid over-heating or fire hazards caused by overload.

### Battery

- Improper use or replacement of the battery may result in explosion hazard. Replace with the same or equivalent type only.
- The device supports 3.0 V or 3.7 V rechargeable lithium battery or 3.0 V non-rechargeable dry

battery.

- The battery size shall meet the requirements on CR17345 battery according to the IEC60086-2 standard.
- Batteries of improper size cannot be installed, and may cause abnormal shutdown.
- Confirm there is no flammable material within 2 m of the charger during charging.
- DO NOT place the battery near heating or fire source. Avoid direct sunlight.
- DO NOT place the battery in the reach of children.

### **Maintenance**

- If the product does not work properly, please contact your dealer or the nearest service center. We shall not assume any responsibility for problems caused by unauthorized repair or maintenance.
- Wipe the device gently with a clean cloth and a small quantity of ethanol, if necessary.
- If the equipment is used in a manner not specified by the manufacturer, the protection provided by the device may be impaired.
- It is recommended to reboot the device every 2 hours when using it to ensure the device performance.

### **Using Environment**

- Make sure the running environment meets the requirement of the device. The operating temperature shall be -20 °C to 55 °C (-4 °F to 131 °F), and the operating humidity shall be 95% or less.
- DO NOT expose the device to high electromagnetic radiation or dusty environments.
- DO NOT aim the lens at the sun or any other bright light.
- Place the device in a dry and well-ventilated environment.
- When any laser equipment is in use, make sure that the device lens is not exposed to the laser beam, or it may burn out.

### **Emergency**

- If smoke, odor, or noise arises from the device, immediately turn off the power, unplug the power cable, and contact the service center.

### **Manufacture Address**

Room 313, Unit B, Building 2, 399 Danfeng Road, Xixing Subdistrict, Binjiang District, Hangzhou, Zhejiang 310052, China  
Hangzhou Microimage Software Co., Ltd.

COMPLIANCE NOTICE: The thermal series products might be subject to export controls in various countries or regions, including without limitation, the United States, European Union, United Kingdom and/or other member countries of the Wassenaar Arrangement. Please consult your professional legal or compliance expert or local government authorities for any necessary export license requirements if you intend to transfer, export, re-export the thermal series products between different countries.

## Legal Information

Read all information and instructions in this document carefully before using the device and keep it for further reference.

For more device information and instructions, please visit our website at [www.hikmicrotech.com](http://www.hikmicrotech.com). You can also refer to other documents (if any) accompanying the device or scan the QR code (if any) on the packaging to get more information.

**©2022 Hangzhou Microimage Software Co., Ltd. All rights reserved.**

About this Manual

The Manual includes instructions for using and managing the Product. Pictures, charts, images and all other information hereinafter are for description and explanation only. The information contained in the Manual is subject to change, without notice, due to firmware updates or other reasons. Please find the latest version of this Manual at the HIKMICRO website ([www.hikmicrotech.com](http://www.hikmicrotech.com)).

Please use this Manual with the guidance and assistance of professionals trained in supporting the Product.

### Trademarks Acknowledgement

 HIKMICRO and other HIKMICRO's trademarks and logos are the properties of HIKMICRO in various jurisdictions.

Other trademarks and logos mentioned are the properties of their respective owners.

### LEGAL DISCLAIMER

TO THE MAXIMUM EXTENT PERMITTED BY APPLICABLE LAW, THIS MANUAL AND THE PRODUCT DESCRIBED, WITH ITS HARDWARE, SOFTWARE AND FIRMWARE, ARE PROVIDED "AS IS" AND "WITH ALL FAULTS AND ERRORS". HIKMICRO MAKES NO WARRANTIES, EXPRESS OR IMPLIED, INCLUDING WITHOUT LIMITATION, MERCHANTABILITY, SATISFACTORY QUALITY, OR FITNESS FOR A PARTICULAR PURPOSE. THE USE OF THE PRODUCT BY YOU IS AT YOUR OWN RISK. IN NO EVENT WILL HIKMICRO BE LIABLE TO YOU FOR ANY SPECIAL, CONSEQUENTIAL, INCIDENTAL, OR INDIRECT DAMAGES, INCLUDING, AMONG OTHERS, DAMAGES FOR LOSS OF BUSINESS PROFITS, BUSINESS INTERRUPTION, OR LOSS OF DATA, CORRUPTION OF SYSTEMS, OR LOSS OF DOCUMENTATION, WHETHER BASED ON BREACH OF CONTRACT, TORT (INCLUDING NEGLIGENCE), PRODUCT LIABILITY, OR OTHERWISE, IN CONNECTION WITH THE USE OF THE PRODUCT, EVEN IF HIKMICRO HAS BEEN ADVISED OF THE POSSIBILITY OF SUCH DAMAGES OR LOSS.

YOU ACKNOWLEDGE THAT THE NATURE OF THE INTERNET PROVIDES FOR INHERENT SECURITY RISKS, AND HIKMICRO SHALL NOT TAKE ANY RESPONSIBILITIES FOR ABNORMAL OPERATION, PRIVACY LEAKAGE OR OTHER DAMAGES RESULTING FROM CYBER-ATTACK, HACKER ATTACK, VIRUS INFECTION, OR OTHER INTERNET SECURITY RISKS; HOWEVER, HIKMICRO WILL PROVIDE TIMELY TECHNICAL SUPPORT IF REQUIRED.

YOU AGREE TO USE THIS PRODUCT IN COMPLIANCE WITH ALL APPLICABLE LAWS, AND YOU ARE SOLELY RESPONSIBLE FOR ENSURING THAT YOUR USE CONFORMS TO THE APPLICABLE LAW. ESPECIALLY, YOU ARE RESPONSIBLE, FOR USING THIS PRODUCT IN A MANNER THAT DOES NOT INFRINGE ON THE RIGHTS OF THIRD PARTIES, INCLUDING WITHOUT LIMITATION, RIGHTS OF PUBLICITY, INTELLECTUAL PROPERTY RIGHTS, OR DATA PROTECTION AND OTHER PRIVACY RIGHTS. YOU SHALL NOT USE THIS PRODUCT FOR ILLEGAL HUNTING ANIMALS, INVASION OF PRIVACY OR ANY OTHER PURPOSE WHICH IS ILLEGAL OR DETRIMENTAL TO THE PUBLIC INTEREST. YOU SHALL NOT USE THIS PRODUCT FOR ANY PROHIBITED END-USES, INCLUDING THE DEVELOPMENT OR PRODUCTION OF WEAPONS OF MASS DESTRUCTION, THE DEVELOPMENT OR PRODUCTION OF CHEMICAL OR BIOLOGICAL WEAPONS, ANY ACTIVITIES IN THE CONTEXT RELATED TO ANY

NUCLEAR EXPLOSIVE OR UNSAFE NUCLEAR FUEL-CYCLE, OR IN SUPPORT OF HUMAN RIGHTS ABUSES.

PLEASE FOLLOW ALL THE PROHIBITIONS AND EXCEPTIONAL CAVEATS OF ALL APPLICABLE LAWS AND REGULATIONS, IN PARTICULAR, THE LOCAL FIREARMS AND/OR HUNTING LAWS AND REGULATIONS. PLEASE ALWAYS CHECK NATIONAL PROVISIONS AND REGULATIONS BEFORE PURCHASE OR USE OF THIS PRODUCT. PLEASE NOTE THAT YOU MAY HAVE TO APPLY FOR PERMITS, CERTIFICATES, AND/OR LICENSES BEFORE ANY PURCHASING, SELLING, MARKETING AND/OR USING OF THE PRODUCT. HIKMICRO SHALL NOT BE LIABLE FOR ANY SUCH ILLEGAL OR IMPROPER PURCHASING, SELLING, MARKETING, AND END USES AND ANY SPECIAL, CONSEQUENTIAL, INCIDENTAL, OR INDIRECT DAMAGES ARISING THEREOF.

IN THE EVENT OF ANY CONFLICTS BETWEEN THIS MANUAL AND THE APPLICABLE LAW, THE LATTER PREVAILS.

## Regulatory Information

---

**These clauses apply only to the products bearing the corresponding mark or information.**

---

### FCC Information

Note: This product has been tested and found to comply with the limits for a Class B digital device, pursuant to Part 15 of the FCC Rules. These limits are designed to provide reasonable protection against harmful interference in a residential installation. This product generates, uses, and can radiate radio frequency energy and, if not installed and used in accordance with the instructions, may cause harmful interference to radio communications. However, there is no guarantee that interference will not occur in a particular installation. If this product does cause harmful interference to radio or television reception, which can be determined by turning the equipment off and on, the user is encouraged to try to correct the interference by one or more of the following measures:

- Reorient or relocate the receiving antenna.
- Increase the separation between the equipment and receiver.
- Connect the equipment into an outlet on a circuit different from that to which the receiver is connected.
- Consult the dealer or an experienced radio/TV technician for help.

Please take attention that changes or modification not expressly approved by the party responsible for compliance could void the user's authority to operate the equipment.

This device complies with Part 15 of the FCC Rules. Operation is subject to the following two conditions:

- (1) This device may not cause harmful interference, and
- (2) This device must accept any interference received, including interference that may cause undesired operation.

This equipment complies with FCC radiation exposure limits set forth for an uncontrolled environment.

### EU/UKCA Conformity Statement



This product and - if applicable - the supplied accessories too are marked with "CE" and comply therefore with the applicable harmonized European standards listed under the Directive 2014/30/EU (EMCD), Directive 2014/35/EU (LVD), Directive 2011/65/EU (RoHS), Directive 2014/53/EU.



This product and - if applicable - the supplied accessories too are marked with "UKCA" and comply therefore with the following directives: Radio Equipment Regulations 2017, Electromagnetic Compatibility Regulations 2016, Electrical Equipment (Safety) Regulations 2016, the Restriction of the Use of Certain Hazardous Substances in Electrical and Electronic Equipment Regulations 2012.

#### Frequency Bands and Power (for CE/UKCA)

The frequency bands and modes and the nominal limits of transmitted power (radiated and/or conducted) applicable to this radio device are the following: Wi-Fi 2.4 GHz (2.4 GHz to 2.4835 GHz), 20 dBm.



For the device without a supplied power adapter, use the power adapter provided by a qualified manufacturer. Refer to the product specification for detailed power requirements.

For the device without a supplied battery, use the battery provided by a qualified manufacturer. Refer to the product specification for detailed battery requirements.



Directive 2012/19/EU (WEEE Directive): Products marked with this symbol cannot be disposed of as unsorted municipal waste in the European Union. For proper recycling, return this product to your local supplier upon the purchase of equivalent new equipment, or dispose of it at designated collection points. For more information see: [www.recyclethis.info](http://www.recyclethis.info).



According to the Waste Electrical and Electronic Equipment Regulations 2013: Products marked with this symbol cannot be disposed of as unsorted municipal waste in the United Kingdom. For proper recycling, return this product to your local supplier upon the purchase of equivalent new equipment, or dispose of it at designated collection points. For more information see: [www.recyclethis.info](http://www.recyclethis.info).



Directive 2006/66/EC and its amendment 2013/56/EU (Battery Directive): This product contains a battery that cannot be disposed of as unsorted municipal waste in the European Union. See the product documentation for specific battery information. The battery is marked with this symbol, which may include lettering to indicate cadmium (Cd), lead (Pb), or mercury (Hg). For proper recycling, return the battery to your supplier or to a designated collection point. For more information see: [www.recyclethis.info](http://www.recyclethis.info).

According to the Batteries and Accumulators (Placing on the Market) Regulations 2008 and the Waste Batteries and Accumulators Regulations 2009: This product contains a battery that cannot be disposed of as unsorted municipal waste in the United Kingdom. See the product documentation for specific battery information. The battery is marked with this symbol, which may include lettering to indicate cadmium (Cd), lead (Pb), or mercury (Hg). For proper recycling, return the battery to your supplier or to a designated collection point. For more information see: [www.recyclethis.info](http://www.recyclethis.info).

### Industry Canada ICES-003 Compliance

This device meets the CAN ICES-003 (B)/NMB-003 (B) standards requirements.

This device complies with Industry Canada licence-exempt RSS standard(s). Operation is subject to the following two conditions:

- (1) this device may not cause interference, and
- (2) this device must accept any interference, including interference that may cause undesired operation of the device.

Le présent appareil est conforme aux CNR d'Industrie Canada applicables aux appareils radioexempts de licence. L'exploitation est autorisée aux deux conditions suivantes:

- (1) l'appareil ne doit pas produire de brouillage, et
- (2) l'utilisateur de l'appareil doit accepter tout brouillage radioélectrique subi, même si le brouillage est susceptible d'en compromettre le fonctionnement.

This equipment complies with IC RSS-102 radiation exposure limits set forth for an uncontrolled

environment.

ce matériel est conforme aux limites de dose d'exposition aux rayonnements, CNR-102 énoncée dans un autre environnement.

### **KC**

B급 기기: 이 기기는 가정용(B급) 전자파적합기기로서 주로 가정에서 사용하는 것을 목적으로 하며, 모든 지역에서 사용할 수 있습니다.



# HIKMICRO

See the World in a New Way



Facebook: HIKMICRO Outdoor Instagram: hikmicro\_outdoor YouTube: HIKMICRO Outdoor

LinkedIn: HIKMICRO

Website: [www.hikmicrotech.com](http://www.hikmicrotech.com) E-mail: [support@hikmicrotech.com](mailto:support@hikmicrotech.com)

UD32861B