



B SERIES

Thermal Camera User Manual



Contact Us

SAFETY INSTRUCTION

These instructions are intended to ensure that user can use the product correctly to avoid danger or property loss. Please read all the safety information carefully before using.

Technical Support

The <https://www.hikmicrotech.com/en/contact-us.html> portal will help you as a HIKMICRO customer to get the most out of your HIKMICRO products. The portal gives you access to our support team, software and documentation, service contacts, etc.

Calibration Service

We recommend you send the device back for calibration once a year, and please contact the local dealer for the information on maintenance points. For more detailed calibration services, please refer to <https://www.hikmicrotech.com/en/calibrationservices/2>.

Maintenance

- ◆ If the product does not work properly, please contact your dealer or the nearest service center. We shall not assume any responsibility for problems caused by unauthorized repair or maintenance.
- ◆ Wipe the device gently with a clean cloth and a small quantity of ethanol, if necessary.
- ◆ If the equipment is used in a manner not specified by the manufacturer, the protection provided by the device may be impaired.

Laser Light Supplement Warning



Warning: The laser radiation emitted from the device can cause eye injuries, burning of skin or inflammable substances. Prevent eyes from direct laser. Before enabling the Light Supplement function, make sure no human or inflammable substances are in front of the laser lens. The wave length is 650 nm, and the power is less than 1 mW. The laser meets the IEC60825-1:2014 standard.

Laser maintenance: It is not necessary to maintain the laser regularly. If the laser does not work, the laser assembly needs to be replaced in the factory under warranty. Keep the device power off when replacing laser assembly. Caution-Use of controls or adjustments or performance of procedures other than those specified herein may result in hazardous radiation exposure.

Power Supply

- ◆ Input voltage should meet the Limited Power Source (3.7 VDC, 0.5 A) according to the IEC62368 standard. Please refer to technical specifications for detailed information.
- ◆ Make sure the plug is properly connected to the power socket.
- ◆ DO NOT connect multiple devices to one power adapter, to avoid over-heating or fire

hazards caused by overload.

- ◆ Use the power adapter provided by a qualified manufacturer. Refer to the product specification for detailed power requirements.

Battery

- ◆ CAUTION: Risk of explosion if the battery is replaced by an incorrect type. Replace with the same or equivalent type only. Dispose of used batteries in conformance with the instructions provided by the battery manufacturer.
- ◆ Improper replacement of the battery with an incorrect type may defeat a safeguard (for example, in the case of some lithium battery types).
- ◆ Do not dispose of the battery into fire or a hot oven, or mechanically crush or cut the battery, which may result in an explosion.
- ◆ Do not leave the battery in an extremely high temperature surrounding environment, which may result in an explosion or the leakage of flammable liquid or gas.
- ◆ Do not subject the battery to extremely low air pressure, which may result in an explosion or the leakage of flammable liquid or gas.
- ◆ Dispose of used batteries in conformance with the instructions provided by the battery manufacturer.
- ◆ The built-in battery cannot be dismantled. Please contact the manufacture for repair if necessary.
- ◆ For long-term storage of the battery, make sure it is fully charged every half year to ensure the battery quality. Otherwise, damage may occur.
- ◆ Use the battery provided by a qualified manufacturer. Refer to the product specification for detailed battery requirements.
- ◆ DO NOT charge other battery types with the supplied charger. Confirm there is no flammable material within 2 m of the charger during charging.
- ◆ DO NOT place the battery near heating or fire source. Avoid direct sunlight.
- ◆ DO NOT swallow the battery to avoid chemical burns.
- ◆ DO NOT place the battery in the reach of children.
- ◆ When the device is powered off and the RTC battery is full, the time settings can be kept for 4 months.
- ◆ Before the first use, charge the lithium battery for more than 3 hours.

Using Environment



- ◆ Make sure the running environment meets the requirement of the device. The operating temperature shall be -10 °C to 50 °C (14 °F to 122 °F), and the operating humidity shall be 95% or less.
- ◆ Place the device in a dry and well-ventilated environment.
- ◆ DO NOT expose the device to high electromagnetic radiation or dusty environments.
- ◆ DO NOT aim the lens at the sun or any other bright light.
- ◆ When any laser equipment is in use, make sure that the device lens is not exposed to the

laser beam, or it may burn out.

- ◆ DO NOT aim the lens at the sun or any other bright light.
- ◆ The device is suitable for indoor and outdoor uses, but do not expose it in wet conditions.

Symbol Conventions

The symbols that may be found in this document are defined as follows.

<i>Symbol</i>	<i>Description</i>
 Danger	Indicates a hazardous situation which, if not avoided, will or could result in death or serious injury.
 Caution	Indicates a potentially hazardous situation which, if not avoided, could result in equipment damage, data loss, performance degradation, or unexpected results.
 Note	Provides additional information to emphasize or supplement important points of the main text.

Laws and Regulations

- ◆ Use of the product must be in strict compliance with the local electrical safety regulations.

Transportation

- ◆ Keep the device in original or similar packaging while transporting it.
- ◆ Keep all wrappers after unpacking them for future use. In case of any failure occurred, you need to return the device to the factory with the original wrapper. Transportation without the original wrapper may result in damage on the device and the company shall not take any responsibilities.
- ◆ DO NOT drop the product or subject it to physical shock. Keep the device away from magnetic interference.

Emergency

- ◆ If smoke, odor, or noise arises from the device, immediately turn off the power, unplug the power cable, and contact the service center.

Manufacture Address

Room 313, Unit B, Building 2, 399 Danfeng Road, Xixing Subdistrict, Binjiang District, Hangzhou, Zhejiang 310052, China

Hangzhou Microimage Software Co., Ltd.

COMPLIANCE NOTICE

The thermal series products might be subject to export controls in various countries or regions, including without limitation, the United States, European Union, United Kingdom and/or other member countries of the Wassenaar Arrangement. Please consult your professional legal or compliance expert or local government authorities for any necessary export license requirements if you intend to transfer, export, re-export the thermal series products between different countries.

CONTENTS

Chapter 1 Introduction	1
1.1 Important Notice to User	1
1.2 Product Introduction	1
1.3 Main Function	1
1.4 Appearance	2
Chapter 2 Preparation	5
2.1 Charge Device	5
2.2 Power On/Off	5
2.2.1 Set Auto Power-Off.....	5
2.2.2 Set Auto Sleep.....	5
2.3 Live View	6
Chapter 3 Display Settings	7
3.1 Set SuperIR.....	7
3.2 Set Image Modes	7
3.3 Set Palettes	8
3.4 Set Level & Span	8
3.5 Color Distribution.....	9
3.6 Set Screen Brightness.....	9
3.7 Display On-Screen Info.....	10
Chapter 4 (Optional) Set Macro Mode	11
Chapter 5 Temperature Measurement	12
5.1 Set Temperature Measurement Parameters	12
5.2 Set Measurement Tools.....	12
5.3 Enhance High-Temperature Target.....	13
5.4 Set Temperature Alarm.....	13

Chapter 6 Capture and Manage Snapshots 14

 6.1 Capture Snapshots 14

 6.2 View Snapshots 15

 6.3 Export Snapshots 15

 6.4 Generate Report 15

Chapter 7 Device Connections 17

 7.1 Cast Device Screen to PC 17

 7.2 Connect Device to Wi-Fi 17

 7.3 Set Device Hotspot 17

Chapter 8 HIKMICRO Viewer Connection 18

 8.1 Connect via Wi-Fi 18

 8.2 Connect via Hotspot 18

Chapter 9 Maintenance 19

 9.1 Set Time and Date 19

 9.2 Set Language 19

 9.3 Save Operation logs 19

 9.4 Format Storage 19

 9.5 View Device Information 19

 9.6 Upgrade 19

 9.7 Restore Device 20

Chapter 10 FAQ 21

 10.1 Frequently Asked Questions (FAQ) 21

CHAPTER 1 INTRODUCTION

1.1 Important Notice to User

This manual describes and explains the features for multiple camera models. Because the camera models of a series have different features, this manual may contain descriptions and explanations that do not apply to your particular camera model.

Not all the camera models of a series support the mobile applications, software, and all their functions mentioned (or not mentioned) in this manual. Please refer to the user manuals of the application and software for more detailed information.

This manual is updated on a regular basis. It means that this manual may not contain the information about the new features of the latest firmware, mobile clients, and software.

1.2 Product Introduction

The handheld thermography camera is a camera with thermal and visual images. The built-in high-sensitivity IR detector and high-performance sensor detect the temperature changes and measure the real-time temperature.

It helps the users to find the risky part and lower their property loss. The device supports live view, capturing snapshots, etc. It is mainly applied to various industries, such as building, HVAC, and auto industry.

1.3 Main Function

Temperature Measurement

Device detects the real-time temperature, and displays it on the screen.

Alarm

Device outputs audible and visual alarm when the target's temperature is higher than the threshold value.

SuperIR

Device supports **SuperIR** to enhance the object outlines on live view (for some models) and snapshots. This function is subject to your particular camera model.

Client Software Connection (If Applicable)



The camera models that support **Wi-Fi** and **hotspot** can connect to HIKMICRO Viewer. Scan the QR code to download the HIKMICRO Viewer App for live view, capture snapshots, record videos, etc.

Download HIKMICRO Analyzer (<https://www.hikmicrotech.com/en/industrial-products/hikmicro-analyzer-software.html>) to analyze pictures.

 **NOTE** Not all the camera models of this series support the mobile applications, software, and all their functions mentioned (or not mentioned) in this manual. Please refer to the user manuals of the application and software for more detailed information.





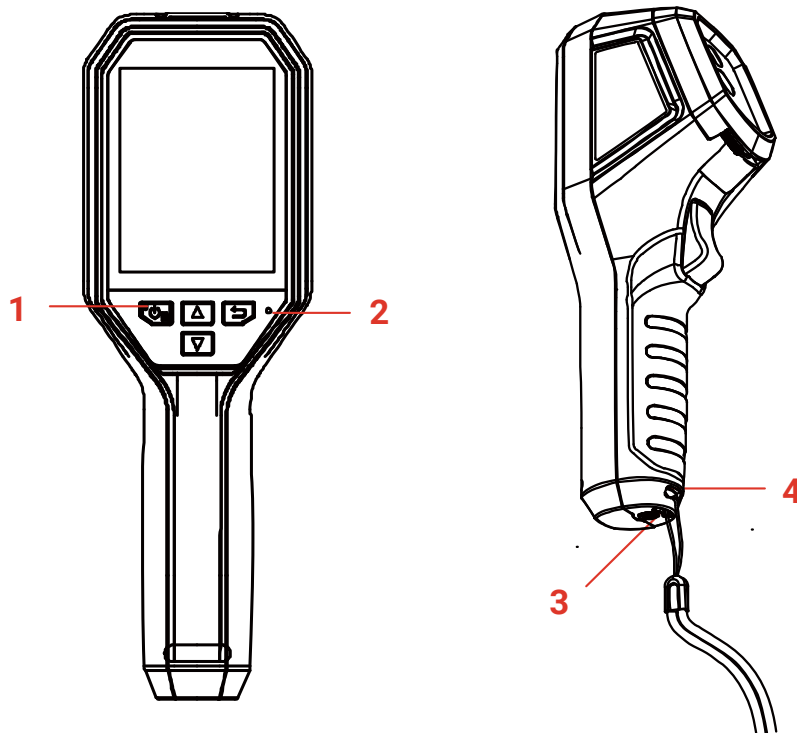

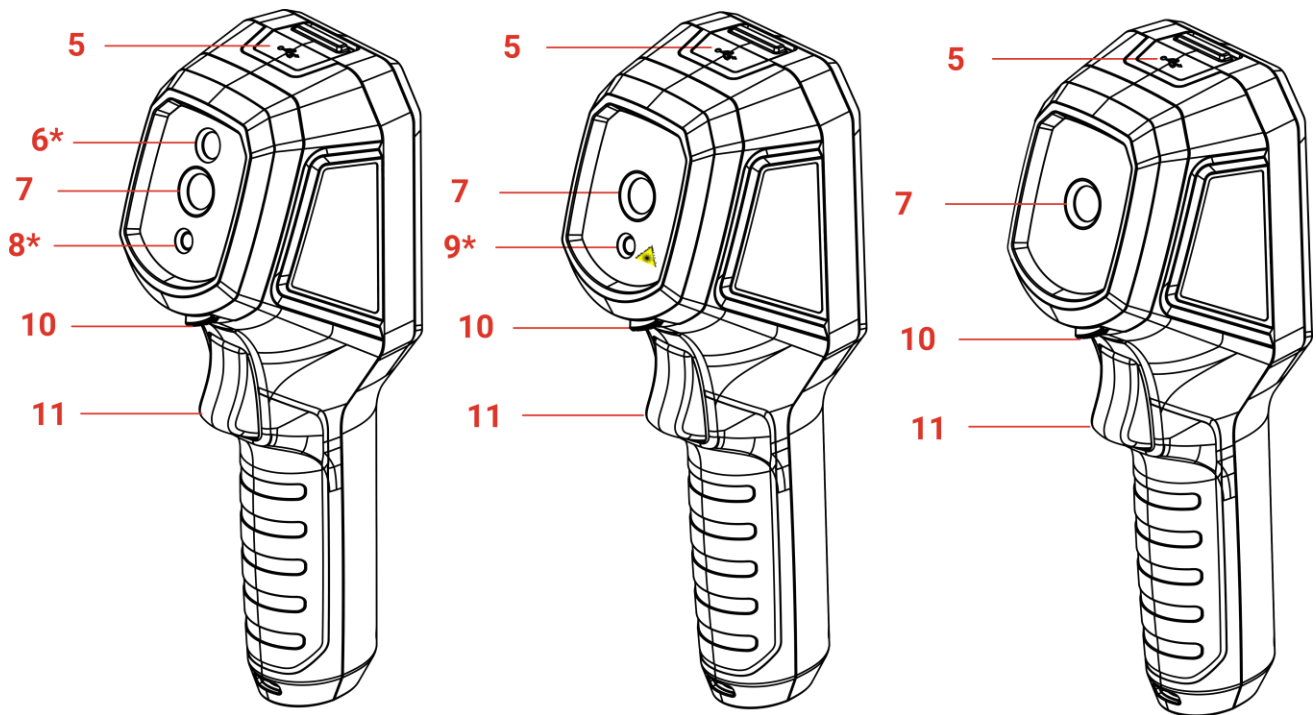

1.4 Appearance

The appearances and components of camera models might be different. Please refer to the actual products.





No.	Component	Function
1	Charging Indicator	<ul style="list-style-type: none"> ◆ Solid Red: Charging. ◆ Solid Green: Fully charged.
2	Buzzer	Output audio alarm.
3	Wrist Strap Hole	Mount the wrist strap.
4	Tripod Mount	Connect to UNC 1/4"-20 tripod.
5	Type-C Interface	Charge the battery or export files using the included USB cable.
6*	Visual Lens*	View the visual image (only supported by certain models).
7	Thermal Lens	View the thermal image.
8*	LED Light*	Provide additional light in the low-light condition.
9*	Laser*	Locate the target with laser light (only supported by certain models).
10	Lens Protector Switch	Turn on/off the thermal lens protective cover.
11	Trigger	<p>In live view:</p> <ul style="list-style-type: none"> ◆ Press: Capture snapshots. ◆ Hold: Locate the target with laser light (for the models with laser light), and release to capture snapshots. <p>In menu mode, press the trigger to go back to live view.</p>

Button	Function
	<ul style="list-style-type: none"> ◆ Hold: Power On/Off ◆ Press: Display menu or confirm operation.
	Exit the menu or return to previous menu.
	In menu mode: Press  and  to select parameters.
	In live view mode: Press  to switch image modes (only supported by certain models). Press  to switch palettes.

 NOTE	<ul style="list-style-type: none"> ◆ The appearance and button functions vary according to different models. ◆ The visual lens, LED light, and laser, are only supported by certain models. Please refer to the actual device or datasheet. ◆ The warning sign is beside the laser and on the left side of the device.
---	---



Warning:

The laser radiation emitted from the device can cause eye injuries, burning of skin or inflammable substances. Prevent eyes from direct laser. Before enabling the Light Supplement function, make sure no human or inflammable substances are in front of the laser lens. The wave length is 650 nm, and the power is less than 1 mW. The laser meets the IEC60825-1:2014 standard.

CHAPTER 2 PREPARATION

2.1 Charge Device

You can charge the camera by connecting it to the power supply via the included USB cable in the package and a power adapter. Do not use the USB-C to USB-C cable of other manufacturers.

The power adapter (not included) should meet the following standards:

- ◆ Output Voltage/Current: 5 VDC/2 A
- ◆ Minimum Power Output: 10 W

1. Lift the type-C interface cover.
2. Plug in the supplied USB cable, and connect the device to the power supply via a power adapter to charge the camera.

**NOTE**

- ◆ The device is equipped with the built-in battery. For the first charge, charge the device for more than 3 hours when the device is turned on.
- ◆ If the camera is not in use for an extended period and is over-discharged, it is recommended to charge for at least 30 min before powering it on.
- ◆ It is recommended to use the USB cable included in the package for both charging and data transfer.

2.2 Power On/Off

Power On

Remove the thermal lens protective cover, and hold  for over six seconds to turn on the device. You can observe the target when the interface of the device is stable.

Power Off

When the device is turned on, hold  for about three seconds to power off the device.

2.2.1 Set Auto Power-Off

In the live view interface, press , and go to **More Settings > Auto Power-off** to set the automatic shutdown time for device as required.

2.2.2 Set Auto Sleep

In live view interface, press , and go to **More Settings > Auto Sleep** to set the waiting time before auto sleep. When there is no button pressing on the device for more than the set waiting time, the device enters sleep mode automatically. Press a button to wake the

device up.

2.3 Live View

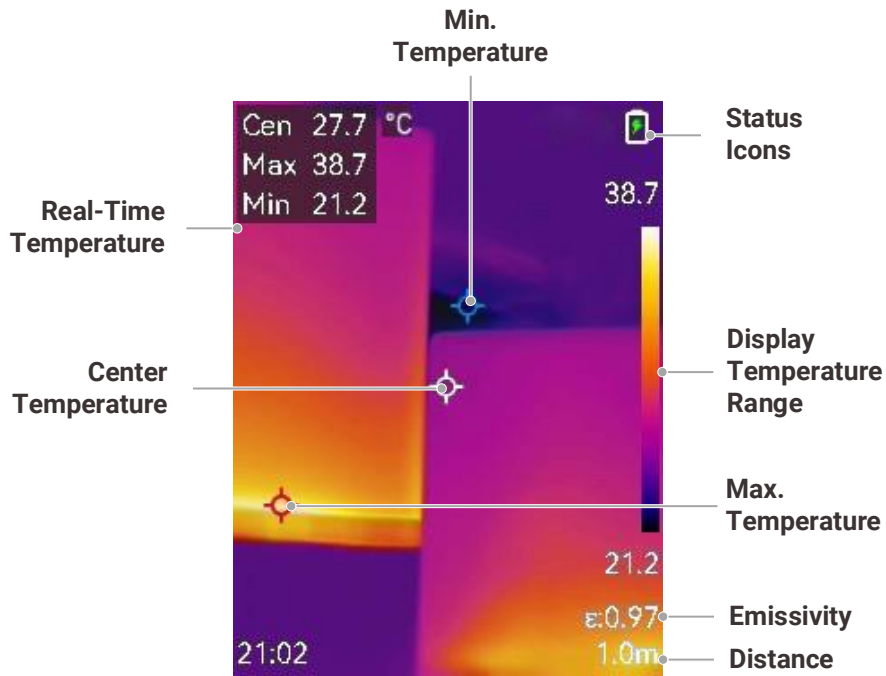

NOTE

Because this manual is updated on a regular basis, the live view might be slightly different from the version of your particular camera model. Please refer to the actual camera.

CHAPTER 3 DISPLAY SETTINGS

3.1 Set SuperIR

The device supports **SuperIR** on live view (for some models) and on snapshots. Turn on **SuperIR** to enhance the object outlines for better image display. The actual effect is subject to the actual product.

Go to **Settings > SuperIR**, and press  to turn it on/off.

- ◆ On live view: For some models, the object outlines can be enhanced in live view when SuperIR is on.
- ◆ On captured images: the object outlines in the image are enhanced after SuperIR is on.

3.2 Set Image Modes

You can set image modes of the device. **Image Mode** is only supported by certain models. Please refer to the actual device or the datasheet.

1. Select an image mode by the following ways:

- ◆ Go to **Settings > Image Settings > Image Mode**, and select a preferred image mode.
- ◆ Press  in live view to switch image modes.





<i>Image Mode</i>	<i>Description</i>	<i>Example</i>
Thermal	In thermal mode, the device displays the thermal view.	
Fusion	Thermal object image with visual outlines. This function is only supported by the models with visual lens.	
PIP	In PIP (Picture in Picture) mode, the device displays thermal view inside the visual view. This function is only supported by the models with visual lens.	

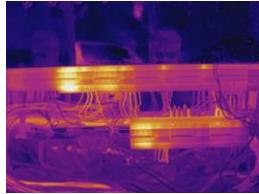
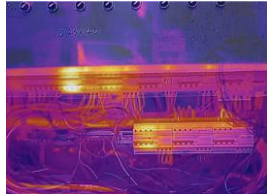
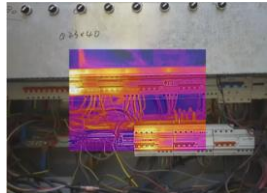

Image Mode	Description	Example
Visual	Visual object image only. This function is only supported by the models with visual lens.	

- When selecting the fusion or PIP mode, you need to select the distance in **Image Settings > Parallax Correction** according to the distance to the target, so as to better overlap the thermal and visual images.
- Press  to save and exit.

 **NOTE** Your camera will periodically perform a self-calibration to optimize image quality and measurement accuracy. In this process, the image will pause briefly and you'll hear a "click" as a shutter moves in front of the detector. The prompt "Image Calibrating ..." appears in the upper center of the screen as the device is calibrating itself. The self-calibration will be more frequent during start up or in very cold or hot environments.







3.3 Set Palettes

The palettes allow you to select the desired colors. You can switch palettes by the following ways:

- Go to **Settings > Palettes** to select a preferred palette, and press  to save and exit.
- Press  in live view to switch palettes.

3.4 Set Level & Span

Set a display temperature range and palette only works for targets within the temperature range. You can get better image contrast by adjusting the level & span parameters.

- In the live view interface, press  to show the menu.
- Press , and select **Level & Span**.
- Select **Setting Mode**, and press  to switch auto and manual adjustment.
 - In **Auto** mode, the device adjusts display temperature range automatically.
 - In **Manual** mode, select **Parameters** to enter the setting interface. Press  to lock or unlock the max. temperature and min. temperature, and press  to adjust unlocked value. Or, unlock the max. temperature and min. temperature, and press  to increase or decrease the individual values while remaining the same temperature range.

4. Press  to save and exit.

3.5 Color Distribution

Color distribution function provides different image display effects in auto level & span. Linear and histogram color distribution modes can be selected for different application scenes.

1. Go to **Image Settings > Color Distribution**.
2. Select a color distribution mode.

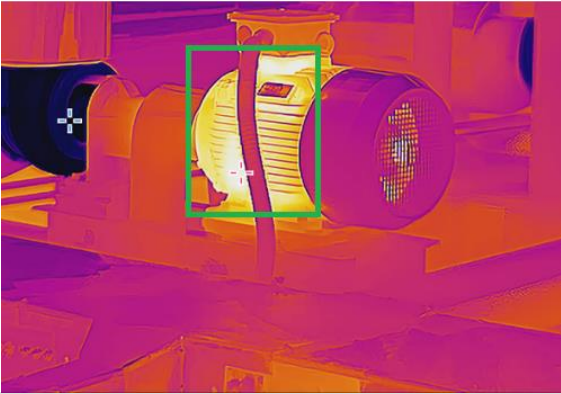
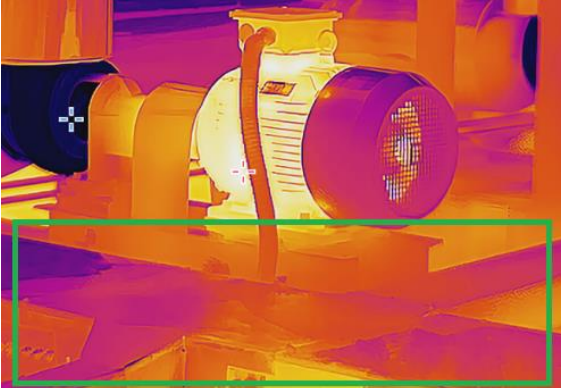
Mode	Description	Example
Linear	Linear mode is used to detect small high temperature targets in low temperature background. Linear color distribution enhances and displays more details of high temperature targets, which is good for checking small high temperature defective areas such as cable connectors.	
Histogram	Histogram mode is used to detect temperature distribution in large areas. Histogram color distribution enhances high temperature targets and remains some details of low temperature objects in the area, which is good for discovering small low temperature targets such as cracks.	

3. Press  to save and exit.



NOTE

This function is only supported in auto level & span.

3.6 Set Screen Brightness

Go to **Settings > Display Settings > Screen Brightness** to adjust the screen brightness.

3.7 Display On-Screen Info



Go to **Settings** > **Display Settings** and press  to turn on/off the on-screen information display.

- ◆ **Parameters:** Temperature measurement parameters, for example, target emissivity, distance, etc.
- ◆ **Brand Logo:** The brand logo is a manufacturer logo overlapped on images.

CHAPTER 4 (OPTIONAL) SET MACRO MODE

The macro mode is used to observe and capture very small objects. The camera can measure the temperature for the very small objects and locate the temperature exception points.

Before You Start

- ◆ Install the macro lens before using this function. Refer to the quick start guide of the macro lens for detailed operation.
 - ◆ The macro lens is not included in the package. Please purchase it separately.
1. In the live view interface, press  and go to **Image Settings > Macro Mode**.
 2. Press  to enable the function.
 3. Press  to save and exit.



NOTE





- ◆ After enabling the macro mode, only the emissivity can be modified. Parameters such as distance, image mode, parallax correction, and measurement range cannot be modified.
- ◆ After this function is turned off, the parameters will be restored to the previous set values, and the temperature range will be set to auto switch.

CHAPTER 5 TEMPERATURE MEASUREMENT

The temperature measurement function provides the real-time temperature of the scene. The device displays the measurement results on the left of your screen. This function is turned on by default.









5.1 Set Temperature Measurement Parameters

You can set temperature measurement parameters before measuring temperature to improve the accuracy of temperature measurement.

1. In the live view interface, press  to show the menu.
2. Press  to select desired parameters.
 - ◆ **Temperature Range:** Select the temperature measurement range. The device can detect the temperature and switch temperature measurement range automatically in **Auto Switch** mode.
 - ◆ **Emissivity:** Enable **Custom**, and select **Emissivity** to set the emissivity of the target as the effectiveness in emitting energy as thermal radiation by pressing . Or you can select a preset emissivity.
 - ◆ **Distance:** Set the distance between the target and the device.
 - ◆ **Unit:** Go to **Display Settings** > **Unit**, and press  to set the temperature unit.
3. Press  to save and exit.

5.2 Set Measurement Tools

Device measures the temperature of the whole scene and can be managed to display the center, hot, and cold spot in the scene.



1. In the live view interface, press  to show the menu.
2. Press  to select **Display Settings**.
3. Select the desired spots to show their temperatures, and press  to enable them.
 - ◆ **Hot:** Display the hot spot in the scene and show the max. temperature.
 - ◆ **Cold:** Display the cold spot in the scene and show the min. temperature.
 - ◆ **Center:** Display the center spot in the scene and show the center temperature.
4. **Optional:** You can customize the user-defined spots if needed.
 - 1) Select a user-defined spot, and press .
 - 2) Press /// to adjust the position of the spot.
 - 3) Press the trigger to finish setting.
5. Press  to save and exit.

Result

The device shows the real-time temperature on the upper left side of live view interface.



5.3 Enhance High-Temperature Target

In target enhancement function, when the target's temperature is higher than the set value, the target will become red. This function is only supported by certain models. Please take the actual product for reference

1. You can enable target enhancement function by the following ways:
 - ◆ Go to **Settings > Palettes**, and select **Above Alarm**.
 - ◆ Press  in live view to switch the palette to **Above Alarm**.
2. Go to **Settings > Palettes > Temperature**, and press  to configure the enhancement temperature threshold. When the temperature of target is higher than the set value, the target will be red in live view.
3. Press  to save and exit.

5.4 Set Temperature Alarm

Set the alarm rules and the device will alarm when the temperature triggers the rule.

1. In the live view interface, press  to show the menu.
2. Press , and select **Alarm**.
3. Press  to enable the function.
 - ◆ **Flashing Alarm**: The LED light flashes when the target temperature exceeds the alarm threshold (only supported by certain models).
 - ◆ **Audible Warning**: The device beeps when target temperature exceeds the alarm threshold.

**NOTE**

The LED light will turn off automatically after enabling flashing alarm.

4. Select **Measurement** to set the alarm rule. Select **Alarm Threshold** to set the threshold temperature. When the target's temperature is higher or lower than the threshold value, the device will output alarm.
5. Press  to save and exit.

CHAPTER 6 CAPTURE AND MANAGE SNAPSHOTS

6.1 Capture Snapshots

You can capture snapshots in live view, and a thumbnail of the snapshot is displayed in live view. The snapshot will be automatically saved in the albums.

In the live view interface, you can capture snapshots by the following ways.

- ◆ Press and release the trigger in live view to capture snapshots.
- ◆ Hold the trigger in live view to locate the target with laser light, and release the trigger to capture snapshots (only supported by the models with laser light).



NOTE

- ◆ For models with LED light, go to **More Settings > LED Light** to turn on/off LED light in the dark environment.
- ◆ For models with laser, go to **More Settings > Laser** to turn on/off laser light.
- ◆ You cannot capture snapshots when the device is connected with PC.

You can also set the following parameters in **Settings > Capture Settings** before capturing snapshots.









Parameters	Description
Capture Mode	<ul style="list-style-type: none"> ◆ Capture One Image: Press the trigger once to capture one image. ◆ Scheduled Capture: Set Interval (the time interval of each snapshot to be taken) and Number (the number of snapshots to be taken in a roll, ranging from 1 to 10,000) for scheduled capture. Press the trigger in live view, and the device captures the set number of images according to the set interval. Press the trigger again to stop capturing.
File Naming	The files can be named after Time Stamp or Numbering (filename header + sequence number).
Save Visual Image	If a visual image is needed to be saved separately, you can enable Save Visual Image (only supported by the models with visual lens).



NOTE

For **Scheduled Capture**, a counter displays in live view showing the completed amounts of capturing.

6.2 View Snapshots

1. In the live view interface, press  to show the menu.
2. Press  to select **Albums**, and press  to enter the album.
3. Press  to select the picture, and press  to view it.
4. **Optional:** Press  to delete picture in picture view interface. Press  to switch the picture.
5. Press  to exit.

6.3 Export Snapshots

6.3.1 Export via HIKMICRO Viewer

If your camera models support **Wi-Fi** and **Hotspot**, you can export snapshots via HIKMICRO Viewer.

1. Launch HIKMICRO Viewer and add the device. Refer to *Chapter 8 HIKMICRO Viewer Connection*.
2. Select **On-Device Files** on the app to access the on-device albums.
3. Select a file, and tap **Download** to save to your local albums.

6.3.2 Export via PC

1. Connect the device to your PC with the supplied USB cable, and select **USB Drive** mode in the prompt on device.
2. Open the detected disk, copy and paste the videos or snapshots to PC to view the files.
3. Disconnect the device from your PC.



**NOTE**

For the first connection, the driver will be installed automatically.

6.4 Generate Report

For the models with **Wi-Fi** and **Hotspot**, you can generate reports of radiometric images via HIKMICRO Viewer for further analysis.

1. Add the device to HIKMICRO Viewer. Refer to *Chapter 8 HIKMICRO Viewer Connection*.
2. Tap Albums on the app to enter the albums.
3. Tap  to select the radiometric images to be analyzed. You can select at most 30 images.

4. Tap  to generate reports. You can choose from **Thermography Report** and **Temperature Curve Report (Simplistic)**.
5. Enter the information according to your needs, and tap **Next** to generate reports.
6. Optional: Edit **NOTES** for the report.
7. Optional: Tap  to share the report or save as a local file.



NOTE

The operations on the app may be different due to the app upgrades. Please refer to the user manual of the app for detailed information.





CHAPTER 7 DEVICE CONNECTIONS

7.1 Cast Device Screen to PC

The device supports casting screen to PC by UVC protocol-based client software or player. You can connect the device to your PC via the supplied USB cable, and cast the real-time live view of the device to your PC.

1. Download the UVC protocol-based client software from our official website:
<https://www.hikmicrotech.com/en/industrial-products/uvc-client/>
2. Connect the device to your PC via the supplied USB cable, and select **USB Cast Screen** in the prompt on the device as the USB mode. Exporting files via USB connection is not allowed when you are casting the screen.
3. Open UVC Alarm Client on your PC.



7.2 Connect Device to Wi-Fi

1. In the live view interface, press  and go to **More Settings > WLAN**.
2. Press  to enable the function.
3. Press  to select Wi-Fi, and enter the password.
4. Press  to save and exit.

 **NOTE** ◆ DO NOT enter **space** in your password, or the password may be incorrect.
◆ Wi-Fi function is only supported by certain models. Please refer to your particular camera.

7.3 Set Device Hotspot

With the device hotspot, other equipment with Wi-Fi function can join the device for data transmission.

1. Go to **Settings > More Settings > Hotspot**, and press  to turn on hotspot. You can see the device's hotspot name.
2. Set the hotspot password.
3. Press  to save and exit.

 **NOTE** ◆ DO NOT enter **space** in your password, or the password may be incorrect.
◆ Hotspot function is only supported by certain models. Please refer to your particular camera.

CHAPTER 8 HIKMICRO VIEWER CONNECTION

For the device supports both Wi-Fi connection and hotspot, you can connect the device to HIKMICRO Viewer app, and operate the device via the app. This function is only supported by certain models. Please refer to the actual device.

8.1 Connect via Wi-Fi

Before You Start

Download and install HIKMICRO Viewer on your phone. See **7.2 Connect Device to Wi-Fi** for instructions.

1. Connect your device to a Wi-Fi network.
2. Add the device to the app.
 - ◆ Using Wi-Fi password.
 - 1) Enter password on phone to join the same Wi-Fi network.
 - 2) Launch the app and follow the startup wizard to search and add the device to the app.
 - ◆ Scanning the Wi-Fi QR code.
 - 1) Select the connected Wi-Fi, and press  on device to show the Wi-Fi QR code.
 - 2) Launch the app to scan to join the same Wi-Fi and add the device.

8.2 Connect via Hotspot

Before You Start

Download and install HIKMICRO Viewer on your phone.

1. Turn on the device hotspot and complete hotspot settings. See **7.3 Set Device Hotspot** for instructions.
2. Add the device to the app.
 - ◆ Using hotspot password:
 - 1) Enable the Wi-Fi function of other equipment and search the device hotspot to join.
 - 2) Launch the app and add the device.
 - ◆ Using hotspot QR code: Scan the QR code with HIKMICRO Viewer to join the hotspot, and add the device.

**NOTE**

For detailed instructions about adding the camera to the mobile application, please refer to the user manual embedded in the application.

CHAPTER 9 MAINTENANCE

9.1 Set Time and Date

In the live view interface, press  and go to **Display Settings > Time and Date** to set the information.

9.2 Set Language



Go to **More Settings > Language** to select a required language.

9.3 Save Operation logs

The device can collect its operation logs and save in the storage only for troubleshooting. You can turn on/off this function in **Settings > More Settings > Save Logs**.

You can connect the camera to PC using the supplied USB cable, and select USB Drive as the USB mode on camera to export the operation logs (.log files) in the root directory of the camera, if necessary.

9.4 Format Storage

1. In the live view interface, press  and go to **More Settings > Format Storage**.
2. Press  and select **OK** to start formatting storage.

**NOTE**

Format storage before first use.

9.5 View Device Information

Go to **More Settings > About** to view the detailed information of the camera, such as firmware version, serial number, etc.

9.6 Upgrade

Before You Start:

Download the upgrade file from the official website first.

1. Connect the device to your PC via the supplied USB cable, and select **USB Drive** as the USB mode in the prompt on the device.

2. Copy the upgrade file and replace it to the root directory of the device.
3. Disconnect the device from your PC.
4. Reboot the device and then it will upgrade automatically. The upgrading process will be displayed in the main interface.

**NOTE**

After the upgrading, the device automatically reboot. You can view the current version in **More Settings > About**.

9.7 Restore Device

In the live view interface, press  and go to **More Settings > Restore Device** to initialize the device and restore default settings.

CHAPTER 10 **FAQ**

10.1 Frequently Asked Questions (FAQ)

Scan the following QR code to get device common FAQ.



LEGAL INFORMATION

© Hangzhou Microimage Software Co., Ltd. All rights reserved.

About this Manual

The Manual includes instructions for using and managing the Product. Pictures, charts, images and all other information hereinafter are for description and explanation only. The information contained in the Manual is subject to change, without notice, due to firmware updates or other reasons. Please find the latest version of this Manual at the HIKMICRO website (<http://www.hikmicrotech.com>).

Please use this Manual with the guidance and assistance of professionals trained in supporting the Product.

Trademarks

 **HIKMICRO** and other HIKMICRO's trademarks and logos are the properties of HIKMICRO in various jurisdictions.

Other trademarks and logos mentioned are the properties of their respective owners.

Disclaimer

TO THE MAXIMUM EXTENT PERMITTED BY APPLICABLE LAW, THIS MANUAL AND THE PRODUCT DESCRIBED, WITH ITS HARDWARE, SOFTWARE AND FIRMWARE, ARE PROVIDED "AS IS" AND "WITH ALL FAULTS AND ERRORS". HIKMICRO MAKES NO WARRANTIES, EXPRESS OR IMPLIED, INCLUDING WITHOUT LIMITATION, MERCHANTABILITY, SATISFACTORY QUALITY, OR FITNESS FOR A PARTICULAR PURPOSE. THE USE OF THE PRODUCT BY YOU IS AT YOUR OWN RISK. IN NO EVENT WILL HIKMICRO BE LIABLE TO YOU FOR ANY SPECIAL, CONSEQUENTIAL, INCIDENTAL, OR INDIRECT DAMAGES, INCLUDING, AMONG OTHERS, DAMAGES FOR LOSS OF BUSINESS PROFITS, BUSINESS INTERRUPTION, OR LOSS OF DATA, CORRUPTION OF SYSTEMS, OR LOSS OF DOCUMENTATION, WHETHER BASED ON BREACH OF CONTRACT, TORT (INCLUDING NEGLIGENCE), PRODUCT LIABILITY, OR OTHERWISE, IN CONNECTION WITH THE USE OF THE PRODUCT, EVEN IF HIKMICRO HAS BEEN ADVISED OF THE POSSIBILITY OF SUCH DAMAGES OR LOSS.

YOU ACKNOWLEDGE THAT THE NATURE OF THE INTERNET PROVIDES FOR INHERENT SECURITY RISKS, AND HIKMICRO SHALL NOT TAKE ANY RESPONSIBILITIES FOR ABNORMAL OPERATION, PRIVACY LEAKAGE OR OTHER DAMAGES RESULTING FROM CYBER-ATTACK, HACKER ATTACK, VIRUS INFECTION, OR OTHER INTERNET SECURITY RISKS; HOWEVER, HIKMICRO WILL PROVIDE TIMELY TECHNICAL SUPPORT IF REQUIRED.

YOU AGREE TO USE THIS PRODUCT IN COMPLIANCE WITH ALL APPLICABLE LAWS, AND YOU ARE SOLELY RESPONSIBLE FOR ENSURING THAT YOUR USE CONFORMS TO THE APPLICABLE LAW. ESPECIALLY, YOU ARE RESPONSIBLE, FOR USING THIS PRODUCT IN A

MANNER THAT DOES NOT INFRINGE ON THE RIGHTS OF THIRD PARTIES, INCLUDING WITHOUT LIMITATION, RIGHTS OF PUBLICITY, INTELLECTUAL PROPERTY RIGHTS, OR DATA PROTECTION AND OTHER PRIVACY RIGHTS. YOU SHALL NOT USE THIS PRODUCT FOR ANY PROHIBITED END-USES, INCLUDING THE DEVELOPMENT OR PRODUCTION OF WEAPONS OF MASS DESTRUCTION, THE DEVELOPMENT OR PRODUCTION OF CHEMICAL OR BIOLOGICAL WEAPONS, ANY ACTIVITIES IN THE CONTEXT RELATED TO ANY NUCLEAR EXPLOSIVE OR UNSAFE NUCLEAR FUEL-CYCLE, OR IN SUPPORT OF HUMAN RIGHTS ABUSES.

IN THE EVENT OF ANY CONFLICTS BETWEEN THIS MANUAL AND THE APPLICABLE LAW, THE LATTER PREVAILS.

REGULATORY INFORMATION

These clauses apply only to the products bearing the corresponding mark or information.

FCC Compliance Statement

Note: This product has been tested and found to comply with the limits for a Class B digital device, pursuant to part 15 of the FCC Rules. These limits are designed to provide reasonable protection against harmful interference in a residential installation. This product generates, uses, and can radiate radio frequency energy and, if not installed and used in accordance with the instructions, may cause harmful interference to radio communications. However, there is no guarantee that interference will not occur in a particular installation. If this product does cause harmful interference to radio or television reception, which can be determined by turning the equipment off and on, the user is encouraged to try to correct the interference by one or more of the following measures:

- Reorient or relocate the receiving antenna.
- Increase the separation between the equipment and receiver.
- Connect the equipment into an outlet on a circuit different from that to which the receiver is connected.
- Consult the dealer or an experienced radio/TV technician for help.

Please take attention that changes or modification not expressly approved by the party responsible for compliance could void the user's authority to operate the equipment.

This device complies with part 15 of the FCC Rules. Operation is subject to the following two conditions:

- (1) this device may not cause harmful interference, and
- (2) this device must accept any interference received, including interference that may cause undesired operation.

EU Conformity Statement



This product and - if applicable - the supplied accessories too are marked with "CE" and comply therefore with the applicable harmonized European standards listed under the Directive 2014/30/EU (EMCD), Directive 2014/35/EU (LVD), Directive 2011/65/EU (RoHS).

Hereby, Hangzhou Microimage Software Co., Ltd. declares that this device (refer to the label) is in compliance with Directive 2014/53/EU.

The full text of the EU declaration of conformity is available at the following internet address:

<https://www.hikmicrotech.com/en/support/download-center/declaration-of-conformity/>

For the device without a supplied power adapter, use the power adapter provided by a qualified manufacturer. Refer to the product specification for detailed power requirements.

For the device without a supplied battery, use the battery provided by a qualified manufacturer. Refer to the product specification for detailed battery requirements.



Directive 2012/19/EU (WEEE Directive): Products marked with this symbol cannot be disposed of as unsorted municipal waste in the European Union. For proper recycling, return this product to your local supplier upon the purchase of equivalent new equipment, or dispose of it at designated collection points. For more information see: www.recyclethis.info



Directive 2006/66/EC and its amendment 2013/56/EU (Battery Directive): This product contains a battery that cannot be disposed of as unsorted municipal waste in the European Union. See the product documentation for specific battery information. The battery is marked with this symbol, which may include lettering to indicate cadmium (Cd), lead (Pb), or mercury (Hg). For proper recycling, return the battery to your supplier or to a designated collection point. For more information see: www.recyclethis.info

Industry Canada ICES-003 Compliance

This device meets the CAN ICES-003 (B)/NMB-003 (B) standards requirements.

This device complies with Industry Canada licence-exempt RSS standard(s). Operation is subject to the following two conditions:

- (1) this device may not cause interference, and
- (2) this device must accept any interference, including interference that may cause undesired operation of the device.

This equipment complies with IC RSS-102 radiation exposure limits set forth for an uncontrolled environment.

Conformité Industrie Canada ICES-003

Cet appareil répond aux exigences des normes CAN ICES-003 (B)/NMB-003 (B).

Le présent appareil est conforme aux CNR d'Industrie Canada applicables aux appareils radioexempts de licence. L'exploitation est autorisée aux deux conditions suivantes :

- (1) l'appareil ne doit pas produire de brouillage, et
- (2) l'utilisateur de l'appareil doit accepter tout brouillage radioélectrique subi, même si le brouillage est susceptible d'en compromettre le fonctionnement.

ce matériel est conforme aux limites de dose d'exposition aux rayonnements, CNR-102 énoncée dans un autre environnement

KC

B급 기기: 이 기기는 가정용(B급) 전자파적합기기로서 주로 가정에서 사용하는 것을 목적으로 하며, 모든 지역에서 사용할 수 있습니다.

INFORMATIONEN FÜR PRIVATE HAUSHALTE

1. Getrennte Erfassung von Altgeräten:

Elektro- und Elektronikgeräte, die zu Abfall geworden sind, werden als Altgeräte bezeichnet. Besitzer von Altgeräten haben diese einer vom unsortierten Siedlungsabfall getrennten Erfassung zuzuführen. Altgeräte gehören insbesondere nicht in den Hausmüll, sondern in spezielle Sammel- und Rückgabesysteme.

2. Batterien und Akkus sowie Lampen:

Besitzer von Altgeräten haben Altbatterien und Altakkumulatoren, die nicht vom Altgerät umschlossen sind, die zerstörungsfrei aus dem Altgerät entnommen werden können, im Regelfall vor der Abgabe an einer Erfassungsstelle vom Altgerät zu trennen. Dies gilt nicht, soweit Altgeräte einer Vorbereitung zur Wiederverwendung unter Beteiligung eines öffentlich-rechtlichen Entsorgungsträgers zugeführt werden.

3. Möglichkeiten der Rückgabe von Altgeräten:

Besitzer von Altgeräten aus privaten Haushalten können diese bei den Sammelstellen der öffentlich-rechtlichen Entsorgungsträger oder bei den von Herstellern oder Vertreibern im Sinne des ElektroG eingerichteten Rücknahmestellen unentgeltlich abgeben.

Rücknahmepflichtig sind Geschäfte mit einer Verkaufsfläche von mindestens 400 m² für Elektro- und Elektronikgeräte sowie diejenigen Lebensmittelgeschäfte mit einer Gesamtverkaufsfläche von mindestens 800 m², die mehrmals pro Jahr oder dauerhaft Elektro- und Elektronikgeräte anbieten und auf dem Markt bereitstellen. Dies gilt auch bei Vertrieb unter Verwendung von Fernkommunikationsmitteln, wenn die Lager- und Versandflächen für Elektro- und Elektronikgeräte mindestens 400 m² betragen oder die gesamten Lager- und Versandflächen mindestens 800 m² betragen. Vertreter haben die Rücknahme grundsätzlich durch geeignete Rückgabemöglichkeiten in zumutbarer Entfernung zum jeweiligen Endnutzer zu gewährleisten. Die Möglichkeit der unentgeltlichen Rückgabe eines Altgerätes besteht bei rücknahmepflichtigen Vertreibern unter anderem dann, wenn ein neues gleichartiges Gerät, das im Wesentlichen die gleichen Funktionen erfüllt, an einen Endnutzer abgegeben wird.

4. Datenschutz-Hinweis:

Altgeräte enthalten häufig sensible personenbezogene Daten. Dies gilt insbesondere für Geräte der Informations- und Telekommunikationstechnik wie Computer und Smartphones. Bitte beachten Sie in Ihrem eigenen Interesse, dass für die Löschung der Daten auf den zu entsorgenden Altgeräten jeder Endnutzer selbst verantwortlich ist.

5. Bedeutung des Symbols „durchgestrichene Mülltonne“:



Das auf Elektro- und Elektronikgeräten regelmäßig abgebildete Symbol einer durchgestrichenen Mülltonne weist darauf hin, dass das jeweilige Gerät am Ende seiner Lebensdauer getrennt vom unsortierten Siedlungsabfall zu erfassen ist.



See the World in a New Way



HIKMICRO Thermography



support@hikmicrotech.com



HIKMICRO Thermography



hikmicro_thermography



HIKMICRO



<https://www.hikmicrotech.com/>