

G31 Handheld Thermal Camera



The HIKMICRO G31 high-performance handheld thermal camera is ideal for industrial, predictive, oil and gas, and utility maintenance inspections. HIKMICRO G31 has a high sensitivity (NETD < 35 mK) and high resolution (384 x 288) HIKMICRO VOx detector, and the temperature calibration is up to 650°C. Advanced features help thermal imaging professionals to easily survey equipment and find signs of malfunction, such as GPS and compass annotations, continuous digital zoom, and 1-Tap level and span. Connect HIKMICRO Viewer App or HIKMICRO Analyzer software to transfer, analyze, and share pictures, and generate reports for free.

Key Features

- Thermal resolution: 384 x 288 (110,592 pixels),NETD : < 35 mK (@ 25 °C, F#=1.0)
- Temperature measurement range : -20 °C to 650 °C (-4 °F to 1202 °F)
- Accuracy: Max (±2°C/3.6°F, ±2%)
- 1.x to 8.x continuous digital zoom
- Manual, automatic, and 1-Tap Level and Span
- GPS & compass annotation functions
- Long-distance laser light supplement for thermography targets
- LED light supplement provides light in dark scenarios

▪ Specification

| Infrared Image | |
|---|---|
| IR Resolution | 384 × 288 (110,592 pixels) |
| SuperIR | 768 × 576 (442,368 pixels) |
| NETD | < 35 mK (@ 25°C, F# = 1.0) |
| Image Frequency | 50 Hz |
| Detector Pitch | 17 μm |
| Spectral Range | 7.5 to 14 μm |
| Focal Length | 15 mm |
| F-number | F1.0 |
| Field of View (FOV) | 25° × 19° |
| Spatial Resolution (IFOV) | 1.13 mrad |
| Min. Focus Distance | 0.1 m (0.33 ft) |
| Focus Mode | Laser Assisted AF/Continuous AF/AF/Manual Focus/Touch AF |
| Focus Speed | Approx. 2 second |
| Image Display | |
| Visual Camera | 3264 × 2448 (8 MP) |
| Display | 800 × 480 Resolution, 4.3" LCD Touch Screen |
| Screen Brightness | Manual/Auto |
| Digital Zoom | 1.x to 8.x continuous |
| Color Palettes | White Hot, Black Hot, Rainbow, Ironbow, Red Hot, Fusion, Rain, Blue Red |
| Focus Mode Palette | Above/Below/Interval |
| Color Alarm | Above/Below/Interval/Insulation/Condensation |
| Image Modes | Infrared/Visual/Fusion/PIP/Blending |
| Measurement and Analysis | |
| Object Temperature Range | -20 °C to 650 °C (-4 °F to 1202 °F) |
| Accuracy | Max (±2°C/3.6°F, ±2%) |
| Measurement Tools | Center Spot, Hot Spot, Cold Spot User-definable: Delta T, 10 spots, 1 line, 5 rectangles, and 5 circle |
| Level and Span Mode | Auto/Manual/1-Tap Touch-screen |
| Inspection Route | Yes |
| Data Storage and Communication | |
| Storage Media | Removable 64 GB Micro SD Card |
| Image Storage Capacity | Approx. 60,000 Images |
| Annotations | Voice note: max. 60 seconds; Text note: max. 200 characters |
| Video Storage Capacity | Approx. 54 hours |
| Video File Format | MP4 video and radiometric video |
| Image Format | Radiometric JPEG |
| Radiometric Infrared-Video Streaming (Compressed) | Over UVC, Wi-Fi |

| General | |
|---------------------------|---|
| Wi-Fi | 802.11 b/g/n (2.4 GHz and 5 GHz) |
| Bluetooth | Bluetooth 4.2 |
| USB Interface | USB Type-C |
| HDMI Interface | Yes |
| LED Light | Yes |
| Laser Pointer | Yes |
| Laser | Yes, Class II, Wavelength: 635 nm; Power: < 1 mW |
| Laser Distance Meter | Indoor distance: 50 m (164 ft); Outdoor distance: 10 m (33 ft). |
| Battery Type | Interchangeable and rechargeable Li-ion battery |
| GPS & Compass | Yes |
| Battery Operating Time | Approx. 4 hours |
| Battery Charging Time | Approx. 4 hours fully charged |
| Power Saving Mode | Yes |
| Protection Level | IP54, IEC 60529 |
| Drop Test Height | 2 m (6.56 ft), IEC 60068-2-31 |
| Safety | IEC 61010-1 |
| EMC | EN 301 489-1, EN 301 489-17, EN IEC 61000-6-2, EN IEC 61000-6-3, EN IEC 61326-1, EN IEC 61326-2-2 |
| Vibration | 2 g, IEC 60068-2-6 |
| Shock | 25 g, IEC 60068-2-27 |
| Storage Temperature Range | -20°C to 60°C (-4°F to 140°F) |
| Working Temperature Range | -20°C to 50°C (-4°F to 122°F) |
| Relative Humidity | < 95% non-condensing |
| Weight | Approx. 1058 g (2.33 lb) |
| Dimension | 284.7 × 120.6 × 124.5 mm (11.21 × 4.75 × 4.9 in) |
| Tripod Mounting | UNC ¼"-20 |

▪ Available Model

HM-TP73-15SVF/W-G31

• Dimension

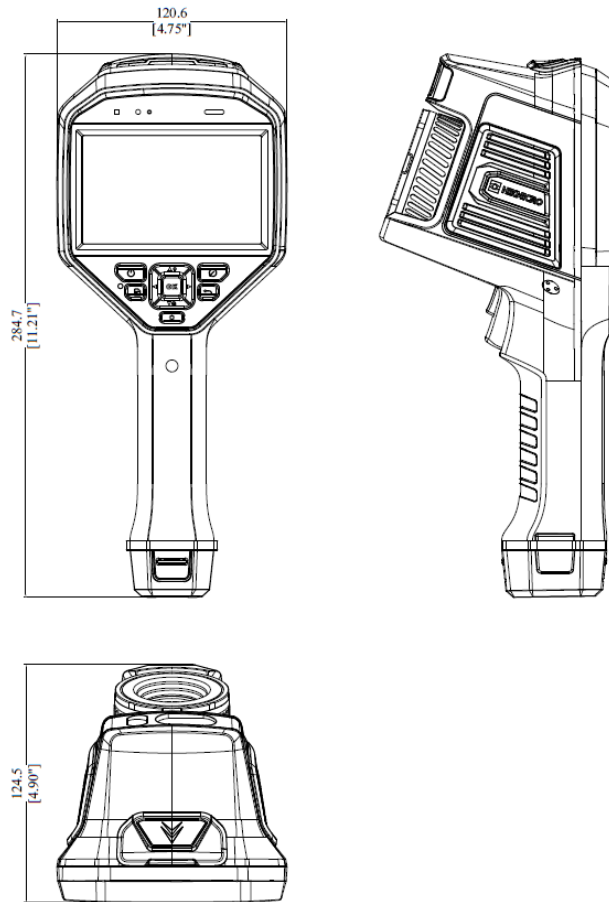

Unit: mm [inch]

• Optional Accessories



HM-5202ZC2
G Series Charging
Base



HM-701ZJ-G01-
SHIELD
Handheld
Thermography
Accessory



INR18650-35E-1S2P
G Series Battery



HM-SP01-POUCH
M/G/SP Series Pouch



HM-G305-LENS1
0.5x wide angle lens,
for G31



HM-G320-LENS1
2x telephoto lens, for
G31









HM-G330-LENS1
3x telephoto lens, for
G31



COMPLIANCE NOTICE: The thermal series products might be subject to export controls in various countries or regions, including without limitation, the United States, European Union, United Kingdom and/or other member countries of the Wassenaar Arrangement. Please consult your professional legal or compliance expert or local government authorities for any necessary export license requirements if you intend to transfer, export, re-export the thermal series products between different countries.



 HIKMICRO Thermography  hikmicro_thermography  HIKMICRO Thermography  HIKMICRO  info@hikmicrotech.com  <http://hikmicrotech.com/en>

© 2023 Hangzhou HIKMICRO Sensing Technology Co., Ltd. All Rights Reserved.
Data subject to change without notice!