

E03 Pocket Thermal Camera



HIKMICRO E03 has a high-resolution VOx detector, an 0.3 MP optical camera, and a 3.5” LCD touch screen. It helps you quickly and efficiently locate hidden problems and accurately measure abnormal temperatures. The wide temperature range of -20°C to 350°C is ideal for building inspection, HVAC, electrical, and mechanical equipment maintenance. The 25 Hz frame rate keeps up with fast inspection. The Pocket Series is a powerful thermography tool in your pocket, so it is always there whenever you need it.

Key Features

- Thermal resolution: 96 × 96 (9,216 pixels), NETD: < 50 mK (@ 25°C, F# = 1.0)
- SuperIR: 240 x 240 (57,600 pixels)
- Accurately measure temperature from -20°C to 350°C (-4°F to 662°F)
- 112:1 Distance to spot ratio (D:S)
- Accuracy: Max. ($\pm 2^{\circ}\text{C}/3.6^{\circ}\text{F}$, $\pm 2\%$)
- Thermal, Fusion, Visual
- Manual, automatic, and 1-Tap level and span
- High temperature alarm
- Built-in 4 GB memory
- LED work light
- 1.0x to 4.0x continuous digital zoom
- 0.3MP visual camera

▪ Specification

Infrared Image	
IR Resolution	96 × 96 (9, 216 pixels)
SuperIR	240 × 240 (57,600 pixels)
Distance to Spot Ratio (D:S)	112:1
NETD	< 50 mK (@ 25 °C, F#=1.0)
Image Frequency	25 Hz
Detector Pitch	12 μm
Spectral Range	7.5 to 14 μm
Focal Length	1.35 mm
F-number	F1.0
Field of View (FOV)	50° × 50°
Spatial Resolution (IFOV)	8.89 mrad
Focus Mode	Focus Free
Min. Focus Distance	0.1 m (0.33 ft)
Image Display	
Visual Camera	640× 480 (0.3 MP)
Display	320 × 240 Resolution, 3.5" LCD Touch Screen
Screen Brightness	Manual
Digital Zoom	1.0x to 4.0x continuous
Color Palettes	White Hot, Black Hot, Rainbow, Ironbow, Rain, Blue Red
Image Modes	Thermal/Visual/Fusion
Measurement and Analysis	
Object Temperature Range	-20°C to 350°C (-4°F to 662°F)
Accuracy	Max (±2°C/3.6°F, ±2%) at ambient temperature 25°C (77°F) and object temperature above 0°C (32°F)
Measurement Tools	Center Spot, Hot Spot, Cold Spot
Level and Span Mode	Auto/Manual/1-Tap Touch-screen
Data Storage and Communication	
Storage Media	Built-in 4 GB flash memory
Image Storage Capacity	Approx. 30,000 Images
Annotations	Text note: max. 200 characters
Video Storage Capacity	Approx. 20 hours
Video File Format	MP4 video
General	
USB Interface	USB Type-C
LED Light	Yes
Battery Type	Rechargeable Li-ion battery
Battery Operating Time	Approx. 4 hours
Battery Charging Time	Approx. 2.5 hours fully charged
Protection Level	IP54
Working Temperature Range	-10°C to 50°C (14°F to 122°F)
Storage Temperature Range	-20°C to 60°C (-4°F to 140°F)
Relative Humidity	< 95% non-condensing
Weight	Approx. 218 g (0.481 lb)

Dimension	138.45 × 85.2 × 23.65 mm (5.45 × 3.35 × 0.93 in)
Tripod Mounting	UNC ¼"-20
Drop Test Height	2 m (6.56 ft)



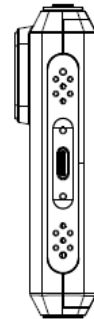
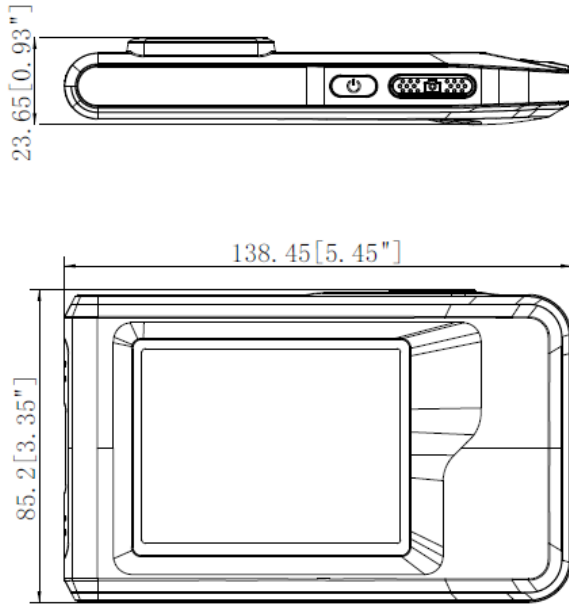



▪ Dimension



Unit: mm[inch]

COMPLIANCE NOTICE: The thermal series products might be subject to export controls in various countries or regions, including without limitation, the United States, European Union, United Kingdom and/or other member countries of the Wassenaar Arrangement. Please consult your professional legal or compliance expert or local government authorities for any necessary export license requirements if you intend to transfer, export, re-export the thermal series products between different countries.



 HIKMICRO Thermography  hikmicro_thermography  HIKMICRO Thermography  HIKMICRO  info@hikmicrotech.com  <http://hikmicrotech.com/en>

© 2023 Hangzhou HIKMICRO Sensing Technology Co., Ltd. All Rights Reserved.
Data subject to change without notice!