



HM-ADAPTER-30A

Adapter

The HM-ADAPTER-30A adapter connects the thermal clip-on and the daylight scope. It supports M52 × 0.75 mm thread, used for HIKMICRO THUNDER Clip-On 2.0.

Specification

GENERAL	
DIMENSION	60 mm × 95 mm × 46.7 mm (2.36" × 3.74" × 1.84")
WEIGHT	76.8 g (0.17 lb)
MOUNTING DIAMETER	30 mm
THREAD	M52 × 0.75 mm
ACCESSORY	Hex Key, Ring

Available Model

HM-ADAPTER-30A

Dimension

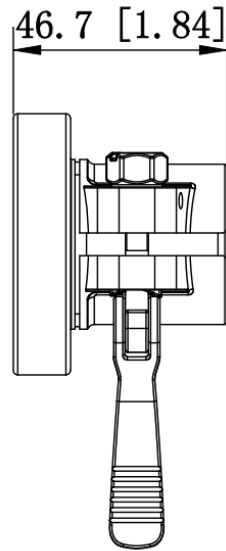
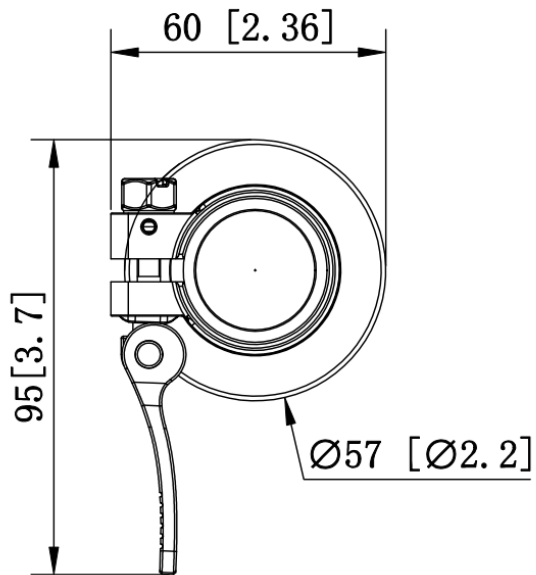

Unit:mm[Inch]



HIKMICRO SIGHT



HIKMICRO Outdoor hikmicro_outdoor HIKMICRO Outdoor HIKMICRO info@hikmicrotech.com <http://hikmicrotech.com/en>

Room 313, Unit B, Building 2, 399 Danfeng Road, Xixing Subdistrict, Binjiang District, Hangzhou, Zhejiang
@hangzhou microimage software co.,Ltd .2020 | data subject to change without notice!