

M20W Handheld Thermography Camera



HIKMICRO M20W handheld thermography camera is specially designed for professional inspections of large objects where a wider FOV captures more of the scene in one picture. It's equipped with a 256 × 192 resolution thermal detector, 50° x 37.2° fixed focus lens, and an 8MP resolution visual camera. The high resolution 3.5-inch touch screen displays crisp, clear images and streamlines camera operations. Imaging modes include thermal, visual, picture in a picture of the optical and thermal view, and fusion of both channels. The M20W quickly identifies potential faults and quantifies the impact with accurate temperature measurement, provides detailed documentation to complete your inspections efficiently.

▪ Features

- High sensitivity thermal module with 256 × 192 resolution
- Supports multiple palettes
- High quality optical module with 8 MP resolution
- Bi-spectrum image fusion, picture-in-picture preview
- Wide temperature measurement range: -20 - 550° C
- High temperature measurement accuracy: Max. ($\pm 2^{\circ}\text{C}/3.6^{\circ}\text{F}$, $\pm 2\%$), for ambient temperature 15°C to 35°C (59°F to 95°F) and object temperature above 0°C (32°F)
- 640 x 480 resolution 3.5" LCD touch display
- Long-distance laser light supplement for thermography targets
- LED light supplement makes the device a torch in required scenarios
- 1.0x to 8.0x continuous digital zoom
- Supports remote album access, download and quick report with APP.

▪ Specification

Infrared Image	
IR Resolution	256 × 192 (49,152 pixels)
SuperIR	512 × 384 (196,608 pixels)
NETD	< 40 mK (@ 25 °C, F#=1.0)
Image Frequency	25 Hz
Detector Pitch	12 μm
Spectral Range	7.5 to 14 μm
Focal Length	3.6 mm
F-number	F1.0
Field of View (FOV)	50° × 37.2°
Spatial Resolution (IFOV)	3.33 mrad
Min. Focus Distance	0.5 m (1.64 ft)
Focus Mode	Focus Free
Image Display	
Visual Camera	3264 × 2448 (8 MP)
Display	640 × 480 Resolution, 3.5" LCD Touch Screen
Screen Brightness	Manual
Digital Zoom	1.0x to 8.0x continuous
Color Palettes	White Hot, Black Hot, Rainbow, Ironbow, Red Hot, Fusion, Rain, Blue Red
Focus Mode Palette	Above/Below/Interval
Color Alarm	Above/Below/Interval/Insulation
Image Modes	Thermal/Visual/Fusion/PIP/Blending
Measurement and Analysis	
Object Temperature Range	Range -20°C to 150°C (-4°F to 302°F) Range 100°C to 550°C (212°F to 1022°F)
Accuracy	Max (±2°C/3.6°F, ±2%), for the ambient temp. 15°C to 35°C (59°F to 95°F) and object temp. above 0°C (32°F)
Measurement Tools	Center Spot, Hot Spot, Cold Spot User-definable: 10 spots, 1 line, 5 rectangles, and 5 circles
Level and Span Mode	Auto/Manual/1-Tap Touch-screen
Data Storage and Communication	
Storage Media	Removable 32 GB Micro SD Card
Image Storage Capacity	Approx. 60,000 Images
Annotations	Voice note: max. 60 seconds; Text note: max. 200 characters
Video Storage Capacity	Approx. 150 hours
Video File Format	MP4 video
General	
Wi-Fi	802.11 b/g/n (2.4 GHz and 5 GHz)
Bluetooth	Bluetooth 4.2

USB Interface	USB Type-C
LED Light	Yes
Laser	Yes, Class II, Wavelength: 635 nm; Power: < 1 mW
Battery Type	Interchangeable and rechargeable Li-ion battery
Battery Operating Time	Approx. 6 hours
Battery Charging Time	Approx. 4 hours fully charged
Protection Level	IP54
Drop Test Height	2 m (6.56 ft)
Safety	IEC 61010-1
EMC	EN 50130-4, EN 55032, EN IEC 61000-3-2, EN 61000-3-3
Vibration	1 g, IEC 60068-2-6
Shock	15 g, IEC 60068-2-27
Working Temperature Range	-10°C to 50°C (-4°F to 122°F)
Storage Temperature Range	-20°C to 70°C (-4°F to 158°F)
Relative Humidity	< 95% non-condensing
Weight	Approx. 660g (1.46 lb)
Dimension	244 × 100 × 104 mm (9.6 × 3.9 × 4.1 in)
Tripod Mounting	UNC ¼"-20
Warranty	3 years for the full product, 10 years for the detector, and 2 years for the battery.

▪ Available Model

HM-TP22-3AQF/W-M20W

▪ Dimension

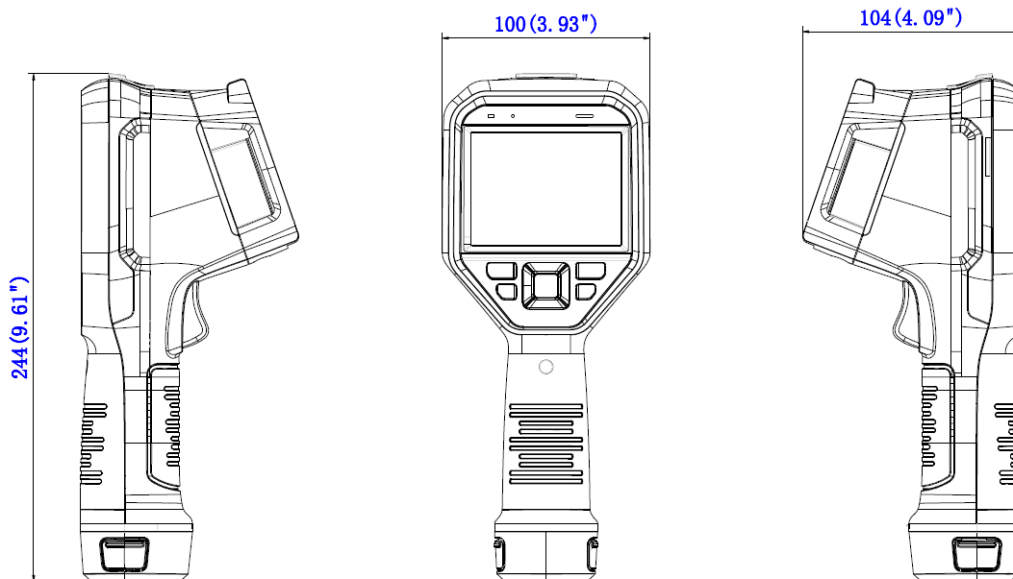

▪ Packaging List

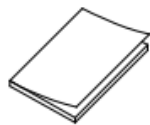

QSG (× 1)

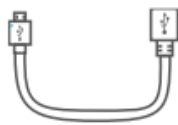

USB 2.0 A to USB Type-C Cable (× 1)



Power Supply for Battery Charger (× 1)

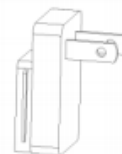

International Use Plugs (US/EU/UK/AU) for Power Supply



Battery (× 2)

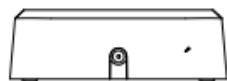

Two-bay Battery Charger (× 1)

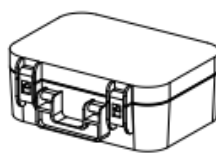

Hard Carrying Case (× 1)



Wrist Strap (× 1)

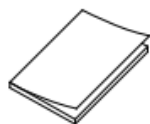

Calibration Certificate

▪ Accessory

▪ Optional

**E097-13-1S1P26650
M Series Battery**



**HM-5202ZC
M Series Charging
Base**



**HM-2925ZJ-TM01-
BRACKET
Tripod Mounting
Bracket**



**HM-SP01-POUCH
M/G/SP Series Pouch**



COMPLIANCE NOTICE: The thermal series products might be subject to export controls in various countries or regions, including without limitation, the United States, European Union, United Kingdom and/or other member countries of the Wassenaar Arrangement. Please consult your professional legal or compliance expert or local government authorities for any necessary export license requirements if you intend to transfer, export, re-export the thermal series products between different countries.



 Hikmicro Industrial

 hikmicro_industrial

 HIKMICRO Industrial

 HIKMICRO

 info@hikmicrotech.com

 www.hikmicrotech.com

© Hangzhou Microimage Software Co., Ltd. All Rights Reserved.

*Note: Specifications are subject to change without notice. For the current specs,
please go to www.hikmicrotech.com