

PocketE Thermal Camera



HIKMICRO PocketE has a high-resolution HIKMICRO VOx detector, an 0.3 MP optical camera, and a 3.5" LCD touch screen. It helps you quickly and efficiently locate hidden problems and accurately measure abnormal temperatures. The wide temperature range of -20°C to 350°C is ideal for building inspection, HVAC, electrical, and mechanical equipment maintenance. The 25 Hz frame rate keeps up with fast inspection, and the Wi-Fi function allows the Pocket to share images in real-time. The Pocket Series is a powerful thermography tool in your pocket, so it is always there whenever you need it.

▪ Features

- IR resolution: 96×96 (9,216 pixels), NETD: < 50 mK (@ 25°C , $F\# = 1.0$)
- Support SuperIR Image enhancement technology on captured image and live view
- Accurately measure temperature from -20°C to 350°C (-4°F to 662°F)
- Support Multiple Scene modes, Some support SuperScene intelligent detection
- Accuracy: Max. ($\pm 2^{\circ}\text{C}/3.6^{\circ}\text{F}$, $\pm 2\%$)
- 25 Hz image frequency
- Thermal, Fusion, PIP, Visual, and Blending modes
- Manual, automatic, and 1-Tap level and span
- LED work light
- 0.3MP visual camera

▪ Specification

Infrared Image	
IR Resolution	96 × 96 (9, 216 pixels)
SuperIR	Yes, on captured images and live view
Distance to Spot Ratio (D:S)	15:1
NETD	< 50 mK (@ 25°C, F#=1.0)
Image Frequency	25 Hz
Detector Pitch	12 μm
Spectral Range	7.5 to 14 μm
Focal Length	1.35 mm
F-number	F1.0
Field of View (FOV)	50° × 50°
Spatial Resolution (IFOV)	8.89 mrad
Focus Mode	Focus Free
Min. Focus Distance	0.1 m (0.33 ft)
Image Display	
Display	320 × 240 Resolution, 3.5" LCD Touch Screen
Image Modes	Thermal/Visual/Fusion/PIP/Blending
Color Palettes	White Hot, Black Hot, Rainbow, Ironbow, Red Hot, Fusion, Blue Yellow
Visual Camera	640× 480 (0.3 MP)
Screen Brightness	Manual
Measurement and Analysis	
SuperScene Mode	Custom, Water Leak, Insulation, Floor Heating, Electrical Faults, Solar Panel
Smart SuperScene Alarm	Water Leak, Insulation, Floor Heating
Alarm	More than, Less than
Alarm Linkage	Flashing Alarm, Alarm Mode Palettes
Temperature Measurement Mode	Measurements presets (center spot,max spot,min spot,off)
Object Temperature Range	Range -20°C to 150°C (-4°F to 302°F) Range 100°C to 350°C (212°F to 662°F)
Accuracy	Max (±2°C/3.6°F, ±2%) at ambient temperature 25°C (77°F) and object temperature above 0°C (32°F)
Level and Span Mode	Auto/Manual/1-Tap Touch-screen
Data Storage and Communication	
Storage Media	Built-in 4 GB flash memory (user available storage space is less than the nominal capacity)
Image Storage Capacity	Approx. 20,000 Images
Image File Format	Radiometric JPEG
Video Storage Capacity	Approx. 37 hours
Video File Format	MP4 video
Annotations	Text note: max. 255 characters
Radiometric Infrared-Video Streaming (Compressed)	Over UVC and Wi-Fi
General	
Wi-Fi	802.11 b/g/n (2.4 GHz)
USB Interface	USB Type-C
LED Light	Yes

Battery Type	Rechargeable Li-ion Battery
Battery Operating Time	Approx. 4 hours
Battery Charging Time	Approx. 3 hours fully charged
Protection Level	IP54
Working Temperature Range	-10°C to 50°C (14°F to 122°F)
Drop Test Height	2 m (6.56 ft)
Storage Temperature Range	-20°C to 60°C (-4°F to 140°F)
Relative Humidity	< 95% non-condensing
Weight	Approx. 218 g (0.481 lb)
Dimension	138.45 × 85.2 × 23.6 mm (5.45 × 3.35 × 0.93 in)
Tripod Mounting	UNC ¼"-20
Power Supply	USB-C (5V/2A)

▪ **Dimension**

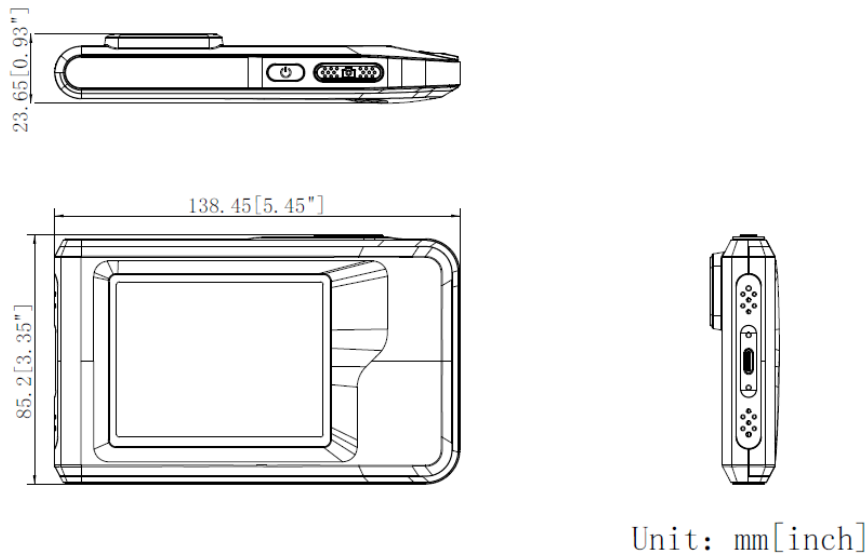

▪ **Packaging List**

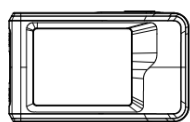

PocketE (X1)

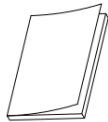

QSG (X1)

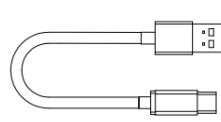

USB Cable (X1)



Wrist Strap (X1)

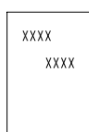

Calibration Certificate (X1)

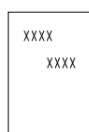

Information For Private Households (X1)

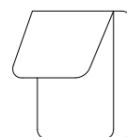

Carrying Pouch (X1)



COMPLIANCE NOTICE: The thermal series products might be subject to export controls in various countries or regions, including without limitation, the United States, European Union, United Kingdom and/or other member countries of the Wassenaar Arrangement. Please consult your professional legal or compliance expert or local government authorities for any necessary export license requirements if you intend to transfer, export, re-export the thermal series products between different countries.



 Hikmicro Industrial

 hikmicro_industrial

 HIKMICRO Industrial

 HIKMICRO

 info@hikmicrotech.com

 www.hikmicrotech.com

© Hangzhou Microimage Software Co., Ltd. All Rights Reserved.

*Note: Specifications are subject to change without notice. For the current specs,
please go to www.hikmicrotech.com