



Thermal Binocular
HIKMICRO Raptor Series

User Manual

Legal Information

©2022 Hangzhou Microimage Software Co., Ltd. All rights reserved.

About this Manual

The Manual includes instructions for using and managing the Product. Pictures, charts, images and all other information hereinafter are for description and explanation only. The information contained in the Manual is subject to change, without notice, due to firmware updates or other reasons. Please find the latest version of this Manual at the HIKMICRO website (www.hikmicrotech.com/).

Please use this Manual with the guidance and assistance of professionals trained in supporting the Product.

Trademarks Acknowledgement

 **HIKMICRO** and other HIKMICRO's trademarks and logos are the properties of

HIKMICRO in various jurisdictions.

Other trademarks and logos mentioned are the properties of their respective owners.

LEGAL DISCLAIMER

TO THE MAXIMUM EXTENT PERMITTED BY APPLICABLE LAW, THIS MANUAL AND THE PRODUCT DESCRIBED, WITH ITS HARDWARE, SOFTWARE AND FIRMWARE, ARE PROVIDED "AS IS" AND "WITH ALL FAULTS AND ERRORS". HIKMICRO MAKES NO WARRANTIES, EXPRESS OR IMPLIED, INCLUDING WITHOUT LIMITATION, MERCHANTABILITY, SATISFACTORY QUALITY, OR FITNESS FOR A PARTICULAR PURPOSE. THE USE OF THE PRODUCT BY YOU IS AT YOUR OWN RISK. IN NO EVENT WILL HIKMICRO BE LIABLE TO YOU FOR ANY SPECIAL, CONSEQUENTIAL, INCIDENTAL, OR INDIRECT DAMAGES, INCLUDING, AMONG OTHERS, DAMAGES FOR LOSS OF BUSINESS PROFITS, BUSINESS INTERRUPTION, OR LOSS OF DATA, CORRUPTION OF SYSTEMS, OR LOSS OF DOCUMENTATION, WHETHER BASED ON BREACH OF CONTRACT, TORT (INCLUDING NEGLIGENCE), PRODUCT LIABILITY, OR OTHERWISE, IN CONNECTION WITH THE USE OF THE PRODUCT, EVEN IF HIKMICRO HAS BEEN ADVISED OF THE POSSIBILITY OF SUCH DAMAGES OR LOSS.

YOU ACKNOWLEDGE THAT THE NATURE OF THE INTERNET PROVIDES FOR INHERENT SECURITY RISKS, AND HIKMICRO SHALL NOT TAKE ANY RESPONSIBILITIES FOR ABNORMAL OPERATION, PRIVACY LEAKAGE OR OTHER DAMAGES RESULTING FROM CYBER-ATTACK, HACKER ATTACK, VIRUS INFECTION, OR OTHER INTERNET SECURITY RISKS; HOWEVER, HIKMICRO WILL PROVIDE TIMELY TECHNICAL SUPPORT IF REQUIRED.

YOU AGREE TO USE THIS PRODUCT IN COMPLIANCE WITH ALL APPLICABLE LAWS, AND YOU ARE SOLELY RESPONSIBLE FOR ENSURING THAT YOUR USE CONFORMS TO THE APPLICABLE LAW. ESPECIALLY, YOU ARE RESPONSIBLE, FOR USING THIS PRODUCT IN A MANNER THAT DOES NOT INFRINGE ON THE RIGHTS OF THIRD PARTIES, INCLUDING WITHOUT LIMITATION, RIGHTS OF PUBLICITY, INTELLECTUAL PROPERTY RIGHTS, OR DATA PROTECTION AND OTHER PRIVACY RIGHTS. YOU SHALL NOT USE THIS PRODUCT FOR ILLEGAL HUNTING ANIMALS, INVASION OF PRIVACY OR ANY OTHER PURPOSE WHICH IS ILLEGAL OR DETRIMENTAL TO THE PUBLIC INTEREST. YOU SHALL NOT USE THIS PRODUCT FOR ANY PROHIBITED END-USES, INCLUDING THE DEVELOPMENT OR PRODUCTION OF WEAPONS OF MASS DESTRUCTION, THE DEVELOPMENT OR PRODUCTION OF CHEMICAL OR BIOLOGICAL WEAPONS, ANY ACTIVITIES IN THE CONTEXT RELATED TO ANY NUCLEAR EXPLOSIVE OR UNSAFE NUCLEAR FUEL-CYCLE, OR IN SUPPORT OF HUMAN RIGHTS

ABUSES.

IN THE EVENT OF ANY CONFLICTS BETWEEN THIS MANUAL AND THE APPLICABLE LAW, THE LATTER PREVAILS.

Regulatory Information

FCC Information

Note: This product has been tested and found to comply with the limits for a Class B digital device, pursuant to Part 15 of the FCC Rules. These limits are designed to provide reasonable protection against harmful interference in a residential installation. This product generates, uses, and can radiate radio frequency energy and, if not installed and used in accordance with the instructions, may cause harmful interference to radio communications. However, there is no guarantee that interference will not occur in a particular installation. If this product does cause harmful interference to radio or television reception, which can be determined by turning the equipment off and on, the user is encouraged to try to correct the interference by one or more of the following measures:

- Reorient or relocate the receiving antenna.
- Increase the separation between the equipment and receiver.
- Connect the equipment into an outlet on a circuit different from that to which the receiver is connected.
- Consult the dealer or an experienced radio/TV technician for help.

Please take attention that changes or modification not expressly approved by the party responsible for compliance could void the user's authority to operate the equipment.

This device complies with Part 15 of the FCC Rules. Operation is subject to the following two conditions:

- (1) This device may not cause harmful interference, and
- (2) This device must accept any interference received, including interference that may cause undesired operation.

This equipment complies with FCC radiation exposure limits set forth for an uncontrolled environment.

EU/UKCA Conformity Statement



This product and - if applicable - the supplied accessories too are marked with "CE" and comply therefore with the applicable harmonized European standards listed under the Directive 2014/30/EU (EMCD), Directive 2014/35/EU (LVD), Directive 2011/65/EU (RoHS).



This product and - if applicable - the supplied accessories too are marked with "UKCA" and comply therefore with the following directives: Radio Equipment Regulations 2017, Electromagnetic Compatibility Regulations 2016, Electrical Equipment (Safety) Regulations 2016, the Restriction of the Use of Certain Hazardous Substances in Electrical and Electronic Equipment Regulations 2012.



Directive 2012/19/EU (WEEE Directive): Products marked with this symbol cannot be disposed of as unsorted municipal waste in the European Union. For proper recycling, return this product to your local supplier upon the purchase of equivalent new equipment, or dispose of it at designated collection points. For more information see: www.recyclethis.info

According to the Waste Electrical and Electronic Equipment Regulations 2013: Products marked with this symbol cannot be disposed of as unsorted municipal waste in the United Kingdom. For proper recycling, return this product to your local supplier upon the purchase of equivalent new equipment, or dispose of it at designated collection points. For more information see: www.recyclethis.info.



Directive 2006/66/EC and its amendment 2013/56/EU (Battery Directive): This product contains a battery that cannot be disposed of as unsorted municipal waste in the European Union. See the product documentation for specific battery information. The battery is marked with this symbol, which may include lettering to indicate cadmium (Cd), lead (Pb), or mercury (Hg). For proper recycling, return the battery to your supplier or to a designated collection point. For more information see: www.recyclethis.info.

According to the Batteries and Accumulators (Placing on the Market) Regulations 2008 and the Waste Batteries and Accumulators Regulations 2009: This product contains a battery that cannot be disposed of as unsorted municipal waste in the United Kingdom. See the product documentation for specific battery information. The battery is marked with this symbol, which may include lettering to indicate cadmium (Cd), lead (Pb), or mercury (Hg). For proper recycling, return the battery to your supplier or to a designated collection point. For more information see: www.recyclethis.info.

Industry Canada ICES-003 Compliance

This device meets the CAN ICES-3 (B)/NMB-3 (B) standards requirements.

This device complies with Industry Canada licence-exempt RSS standard(s). Operation is subject to the following two conditions:

- (1) this device may not cause interference, and
- (2) this device must accept any interference, including interference that may cause undesired operation of the device.

Le présent appareil est conforme aux CNR d'Industrie Canada applicables aux appareils radioexempts de licence. L'exploitation est autorisée aux deux conditions suivantes:

- (1) l'appareil ne doit pas produire de brouillage, et
- (2) l'utilisateur de l'appareil doit accepter tout brouillage radioélectrique subi, même si le brouillage est susceptible d'en compromettre le fonctionnement.

This equipment complies with IC RSS-102 radiation exposure limits set forth for an uncontrolled environment.

ce matériel est conforme aux limites de dose d'exposition aux rayonnements, CNR-102 énoncée



dans un autre environnement.

KC

B급 기기: 이 기기는 가정용(B급) 전자파적합기기로서 주로 가정에서 사용하는 것을 목적으로 하며, 모든 지역에서 사용할 수 있습니다.

Symbol Conventions

The symbols that may be found in this document are defined as follows.

Symbol	Description
 Danger	Indicates a hazardous situation which, if not avoided, will or could result in death or serious injury.
 Caution	Indicates a potentially hazardous situation which, if not avoided, could result in equipment damage, data loss, performance degradation, or unexpected results.
 Note	Provides additional information to emphasize or supplement important points of the main text.

Safety Instruction

These instructions are intended to ensure that user can use the product correctly to avoid danger or property loss.

Laws and Regulations

- Use of the product must be in strict compliance with the local electrical safety regulations.

Transportation

- Keep the device in original or similar packaging while transporting it.
- Keep all wrappers after unpacking them for future use. In case of any failure occurred, you need to return the device to the factory with the original wrapper. Transportation without the original wrapper may result in damage on the device and the company shall not take any responsibilities.
- DO NOT drop the product or subject it to physical shock. Keep the device away from magnetic interference.

Power Supply

- Please purchase the charger by yourself. Input voltage should meet the Limited Power Source (5 VDC, 2A) according to the IEC61010-1 standard. Please refer to technical specifications for detailed information.
- Use the power adapter provided by qualified manufacturer. Refer to the product specification for detailed power requirements.
- Make sure the plug is properly connected to the power socket.
- DO NOT connect multiple devices to one power adapter, to avoid over-heating or fire hazards caused by overload.

Battery

- Improper use or replacement of the battery may result in explosion hazard. Replace with the same or equivalent type only.
- The battery type is 18650 with the protection board, and the battery size should be within 19 mm × 70 mm. The rated voltage and capacity are 3.6 VDC/3.2 Ah.
- The battery size shall meet the requirements on CR17345 battery according to the IEC60086-2 standard.
- Batteries of improper size cannot be installed, and may cause abnormal shutdown.
- Confirm there is no flammable material within 2 m of the charger during charging.
- DO NOT place the battery near heating or fire source. Avoid direct sunlight.
- DO NOT place the battery in the reach of children.

Maintenance

- If the product does not work properly, please contact your dealer or the nearest service center. We shall not assume any responsibility for problems caused by unauthorized repair or maintenance.
- Wipe the device gently with a clean cloth and a small quantity of ethanol, if necessary.

- If the equipment is used in a manner not specified by the manufacturer, the protection provided by the device may be impaired.
- It is recommended to reboot the device every 2 hours when using it to ensure the device performance.

Using Environment

- Make sure the running environment meets the requirement of the device. The operating temperature shall be -30 °C to 55 °C (-22 °F to 131 °F), and the operating humidity shall be 95% or less, no condensing.
- DO NOT expose the device to high electromagnetic radiation or dusty environments.
- DO NOT aim the lens at the sun or any other bright light.
- Place the device in a dry and well-ventilated environment.
- When any laser equipment is in use, make sure that the device lens is not exposed to the laser beam, or it may burn out.

Emergency

- If smoke, odor, or noise arises from the device, immediately turn off the power, unplug the power cable, and contact the service center.

Manufacture Address

Room 313, Unit B, Building 2, 399 Danfeng Road, Xixing Subdistrict, Binjiang District, Hangzhou, Zhejiang 310052, China
Hangzhou Microimage Software Co., Ltd.

COMPLIANCE NOTICE: The thermal series products might be subject to export controls in various countries or regions, including without limitation, the United States, European Union, United Kingdom and/or other member countries of the Wassenaar Arrangement. Please consult your professional legal or compliance expert or local government authorities for any necessary export license requirements if you intend to transfer, export, re-export the thermal series products between different countries.

Table of Contents

Chapter 1 Overview	1
1.1 Device Description	1
1.2 Main Function	1
1.3 Appearance	1
Chapter 2 Preparation	4
2.1 Cable Connection	4
2.2 Install Battery	4
2.3 Power On/Off	6
2.4 Menu Description	6
Chapter 3 Image Settings	7
3.1 Adjust Diopter	7
3.2 Adjust Focus	7
3.3 Adjust Brightness	8
3.4 Adjust Contrast	8
3.5 Select Scene	8
3.6 Set Picture in Picture	9
3.7 Set Custom Palettes	9
3.8 Set Display Mode	12
3.9 Set Fusion Level	12
3.10 Correct Defective Pixel	12
3.11 Flat Field Correction	13
3.12 Infrared Light	13
3.12.1 Smart IR	13
3.13 Image Pro	13
3.14 Adjust Digital Zoom	14
3.15 Set OSD	14
3.16 Set Brand Logo	14

Thermal Binocular User Manual

Chapter 4 Burning Prevention	15
Chapter 5 Hot Tracking	16
Chapter 6 Measure Distance	17
Chapter 7 Geographic Location Display	18
Chapter 8 Direction Display	19
8.1 Calibrate Compass	19
8.2 Magnetic Declination Correction	20
Chapter 9 Picture and Video	21
9.1 Capture Picture	21
9.2 Record Video	21
9.3 Set Audio	21
9.4 View Local Files	22
9.5 Export Files	22
Chapter 10 Client Software Connection	24
Chapter 11 CVBS Output	25
Chapter 12 System Settings	26
12.1 Synchronize Time	26
12.2 Unit Settings	26
12.3 Language Settings	26
Chapter 13 Maintenance	27
13.1 View Device Information	27
13.2 Upgrade Device	27
13.3 Restore Device	27
Chapter 14 Frequently Asked Questions	28
14.1 Why is the monitor off?	28
14.2 The image is not clear, how to adjust it?	28
14.3 Capturing or recording fails. What's the problem?	28
14.4 Why the PC cannot identify the device?	28
Chapter 15 Appendix	29
15.1 Device Command	29
15.2 Device Communication Matrix	29

Chapter 1 Overview

1.1 Device Description

HIKMICRO RAPTOR series is a powerful and innovative handheld thermal and digital night vision binocular which adopts a 12 μ m infrared thermal sensor with NETD < 20mK sensitivity, 2560 × 1440 low illumination optical sensor with built-in adjustable IR illuminator, and a precise built-in laser rangefinder up to 1000 m measuring distance. It offers excellent image quality in true living color or thermal during day and night observation in adverse weather conditions with up to 2600 m detection range. The binocular is mainly applied for day & night observation, hunting, hiking, searching and rescuing.

1.2 Main Function

- Distance Measurement: The device can detect the distance between the target and the device.
- Hot Tracking: The device can detect the highest temperature in the scene and mark the spot.
- Smart IR: The smart IR function helps to view targets clearly in dark environment.
- GPS: Device can locate the target position and can be located with GPS system.
- Compass: The device can detect the azimuth angle and elevation angle of the target and show the direction information on the screen.
- Display Mode: The device supports multiple display modes, and you can set day mode, night mode, defog mode, or auto mode according to the scene.
- Client Software Connection: The device can capture snapshots, record videos, and set parameters by HIKMICRO Sight App after being connected to your phone via hotspot.

1.3 Appearance

The appearance description of the thermal binocular is shown below. Please take the actual product for reference.

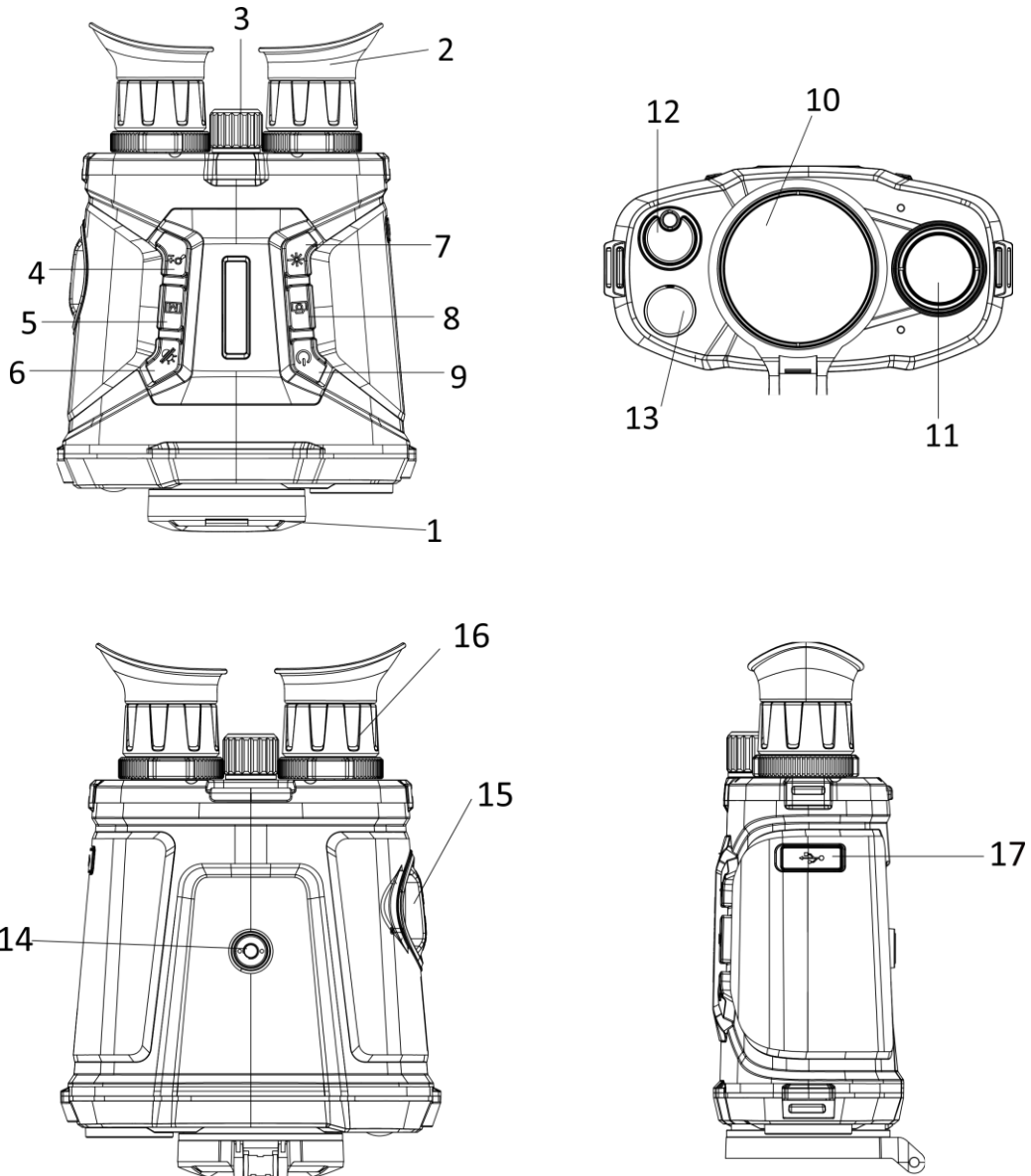

Figure 1-1 Device Appearance

Table 1-1 Buttons and Components

No.	Description	Function
1	Lens Cover	Protect the lens.
2	Eyepiece	The eye end of the device. You can view target from this part.
3	Focus Ring	Adjust focus to obtain clear targets.
4	Zoom Key	<ul style="list-style-type: none"> ● Press: Adjust digital zoom. ● Hold: Enable/disable PIP.
5	Menu Key	<ul style="list-style-type: none"> ● Press: switch palettes. ● Hold: enter/exit menu.

Thermal Binocular User Manual

No.	Description	Function
6	Mode Key	<ul style="list-style-type: none">● Press to switch day/night/defog/auto mode.● Hold: Trigger FFC.
7	Laser Key	<ul style="list-style-type: none">● Press: Measure distance with laser for once.● Hold: Measure distance with laser for continuously.
8	Capture Key	<ul style="list-style-type: none">● Press: Capture snapshots.● Hold: Start/stop recording.
9	Power Key	<ul style="list-style-type: none">● Press: standby mode/wake up device● Hold: Power on/off.
10	Thermal Lens	For thermal imaging.
11	Optical Lens	For optical imaging.
12	Laser Ranger Finder	Measure the distance with laser.
13	Infrared Light	Help to view target clearly in dark environment.
14	Tripod Mount	Mount the tripod.
15	Battery Compartment	The battery compartment can be detached, and you can install batteries in it.
16	Diopter Adjustment Ring	Adjust the dioptric correction.
17	Type-C Interface	Connect to power supply and transmit data.

Chapter 2 Preparation

2.1 Cable Connection

Connect the device and power adaptor with a type-C cable to power on the device. Alternatively, connect the device and PC to export files.

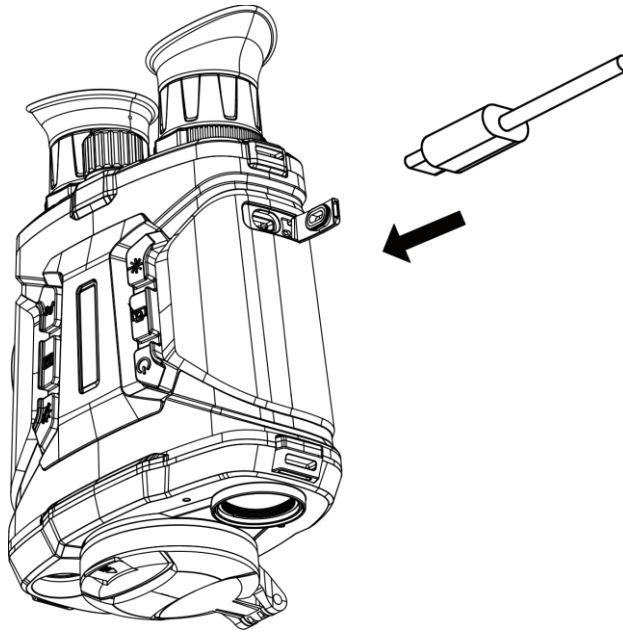

Figure 2-1 Cable Connection

2.2 Install Battery

Insert the batteries into the battery compartment.

Steps

1. Rotate the battery compartment cover counterclockwise to loosen it.

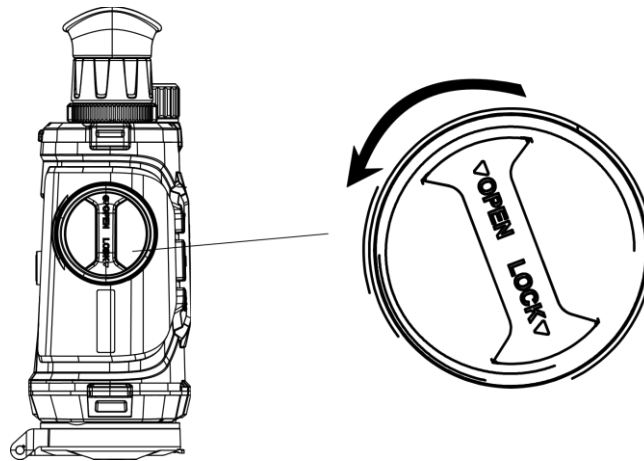

Figure 2-2 Loosen Knob

2. Take out the detachable battery compartment, and install the batteries as the positive and negative marks indicate.

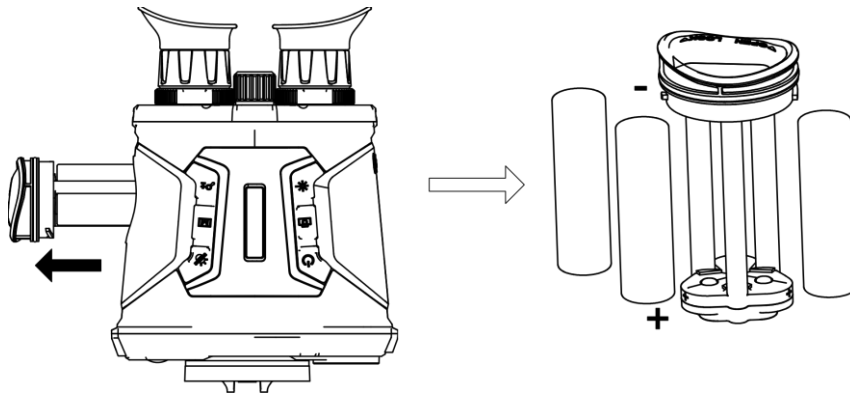

Figure 2-3 Install Batteries

3. Install the battery compartment back, and rotate the battery compartment cover clockwise to lock it.

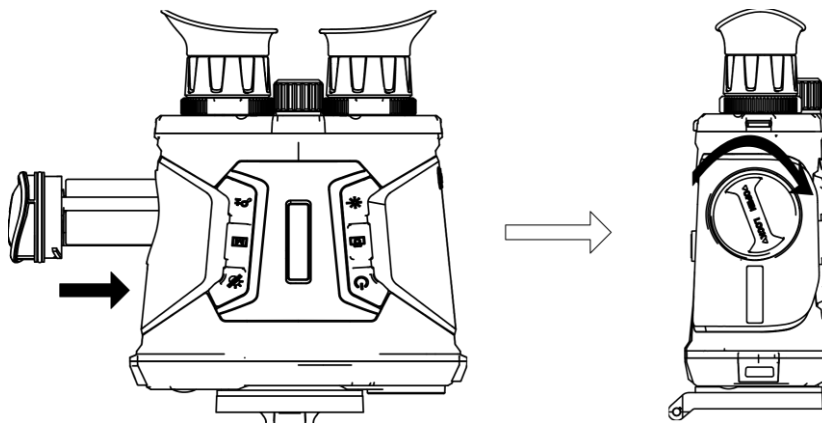

Figure 2-4 Clock Battery Compartment

Note

- Take the battery away if you do not use the device for a long time.

- Charge the batteries with the supplied battery charger for more than 4 hours before first use.
 - The battery type is 18650 with the protection board, and the battery size should be within 19 mm × 70 mm. The rated voltage and capacity are 3.6 VDC/3.2 Ah.
-

2.3 Power On/Off

Power On

When the battery is sufficiently charged, hold  for about 2 seconds to power on the device.

Power Off

When the device is turned on, hold  for about 2 seconds to power off the device.



Auto Power Off

Set the auto power off time for your device, and then the device will automatically shut down as the set time.





Steps

1. Hold  to go to the menu.
 2. Press  or  to select , and press  to select the auto power off time as required.
 3. Hold  to save and exit.
-

Note

- See the battery icon for the battery status.  means the battery is fully charged, and  means that the battery is low.
 - When the low power note shows, charge the battery.
 - The auto power off countdown will start again when the device exits standby mode, or the device is restarted.
-

2.4 Menu Description

When the device is turned on, hold  to enter/exit menu operation. Press  or  to select functions, and press  to confirm.

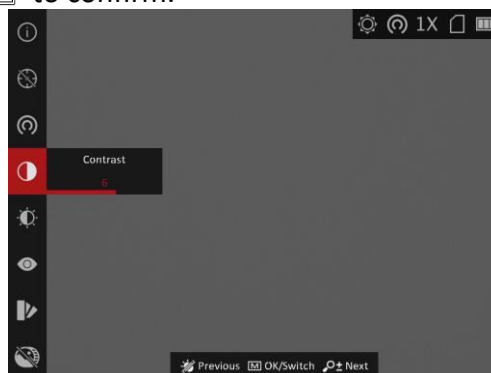

Figure 2-5 Menu Interface

Chapter 3 Image Settings

3.1 Adjust Diopter

Steps

1. Power on the device.
2. Hold the device and make sure the eyepiece covers your eye.
3. Adjust the diopter adjustment ring until the OSD text or image is clear.

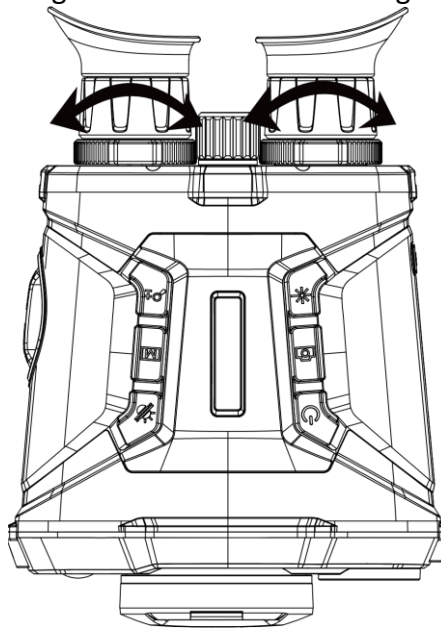

Figure 3-1 Adjust Diopter

Note

When adjusting diopter, DO NOT touch the surface of lens to avoid smearing the lens.

3.2 Adjust Focus

Steps

1. Power on the device.
2. Open the lens cover.
3. Hold the device and make sure the eyepiece covers your eye.
4. Adjust the focus ring until the image is clear.

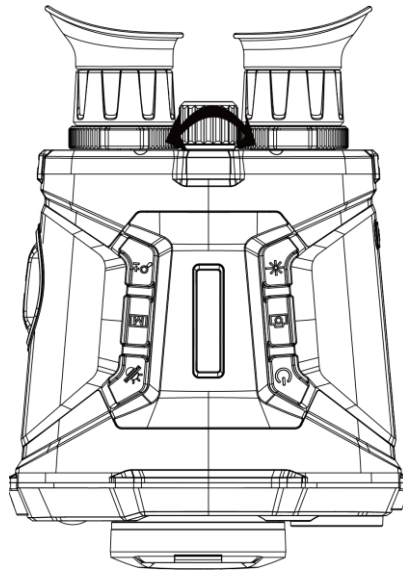



Figure 3-2 Adjust Focus

 **Note**

When adjusting focus, DO NOT touch the surface of lens to avoid smearing the lens.

3.3 Adjust Brightness

In the menu mode, select  and press  to adjust brightness. In white hot mode, the higher the value of brightness is, the brighter the image is. The image effect in white hot mode is showed as picture below and effect in black hot mode is opposite.

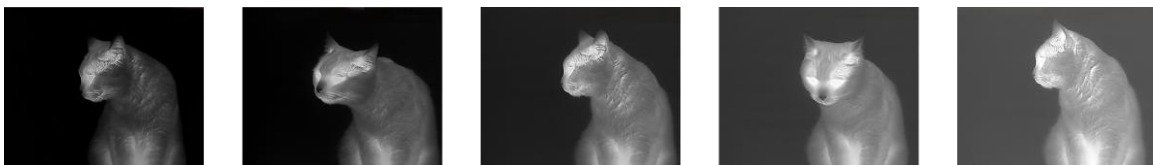



Figure 3-2 Adjust Brightness in White Hot Mode

3.4 Adjust Contrast





In the menu mode, select  and press  to adjust image contrast.

3.5 Select Scene

You can select proper scene according to actual using scene to improve the display effect.

Steps

1. Hold  to go to the menu.

2. Select  and press  to switch scene.
 -  refers to recognition mode and is recommended in normal scene.
 -  refers to jungle mode and is recommended in hunting environment.
3. Hold  to save settings and exit.

3.6 Set Picture in Picture



Hold  in live view mode to enable PIP, and hold  again to exit PIP. The image center is displayed in upper middle of the interface.



Figure 3-3 PIP Mode







Note

If digital zoom is enabled, the PIP view also zooms.

3.7 Set Custom Palettes

You can select different palettes to display the same scene in different effects.

Steps

1. Hold  to go to the menu.
2. Select .
3. Press  to go to the palettes interface.
4. Press  or  to select the palettes required, and press  to enable it/them.

Note

- At least one palette should be enabled.
 - The default palettes are White Hot, Optical, and Fusion.
-

5. Hold  to save the settings and exit.

6. Press  in live view interface to switch the selected palettes.

Optical

The image of optical channel is displayed in this mode.



White Hot

The hot part is light-colored in view. The higher the temperature is, the lighter the color is.



Black Hot

The hot part is black-colored in view. The higher the temperature is, the more black the color is.



Red Hot

The hot part is red-colored in view. The higher the temperature is, the redder the color is.



Fusion

From high temperature to low temperature, the image is colored in from white, yellow, red, pink to purple.



Image Fusion





Fuse the optical image with the thermal image. The fused image with clear edge is displayed in this mode.



3.8 Set Display Mode

You can select different display modes in different scenes.





Press  in live view interface to switch display modes. Day, night, defog, and auto are selectable.

- : Day mode. You can use this mode at daytime and in bright environment. In day mode, the IR light is off automatically.
- : Night mode. You can use this mode at nights and in bright environment. In day mode, the IR light is on automatically.
- : Auto mode. The day mode and night mode switch automatically according to the ambient brightness.
- : Defog mode. You can use this mode in foggy days.

3.9 Set Fusion Level

When the palette is set as image fusion, you can adjust the fusion level according to the actual observation distance to obtain better image fusion effect.

Steps

1. Hold  to show the menu.
2. Select .
3. Press  to switch fusion level.
4. Hold  to save the settings and exit.













3.10 Correct Defective Pixel

The device can correct the defective pixels on the screen which are not performed as expected.

Steps

The device can correct the defective pixels on the screen.

Steps

1. Hold  to show the menu.
2. Select , and press  to enter the DPC setting interface.
3. In the DPC Interface, press  or  to select **Axis**, and press  to switch the moving direction of the cursor. If you select **X**, the cursor moves left and right; if you select **Y**, the cursor moves up and down.
4. Press  or  to move the cursor until it reaches the defective pixel.
5. Press  to set the axis as **N**, and press  or  to select **DPC**.
5. Press  to correct the defective pixel.

Note

- The selected defective pixel can be magnified and displayed at the bottom right of the







interface.

- When the menu or OSD blocks the defective pixel, the menu at the bottom can be hidden, and the menu at the upper left can be mirrored to the upper left of the interface.
-



3.11 Flat Field Correction

This function can correct non-uniformity of display.

Steps

1. Hold  to go to the menu.
2. Select  and press  to switch FFC mode.
 - Manual: Hold  in live view to correct the non-uniformity of display.
 - Auto: The device performs FFC automatically according to the set schedule when switching on the camera.
 - External: Cover the lens cover, then hold  in live view to correct the non-uniformity of display.
3. Hold  to save the settings and exit.

3.12 Infrared Light



The infrared light helps to view targets clearly in dark environment. Select  in menu mode, and press  to turn on infrared light. After you enable this function, the infrared light only works in night mode, or in auto mode and the environment is dark. In other modes, the infrared light does not take effect.

Note

Infrared light cannot be turned on if the battery is low.

3.12.1 Smart IR

Image overexposure may occur in too bright environment. The smart IR function helps to adjust the overexposed images by controlling infrared light intensity, so as to improve the image effect in night mode and dark environment.



In menu mode, select  and press  to enable this function.

3.13 Image Pro

Image pro refers to image detail enhancement. When you enable this function, the details of whole live view interface will be enhanced.

Steps

1. Hold  to show the menu.

2. Select .
3. Press  to enable this function.
4. Hold  to return to the live view interface, and view the target.

Result

The details of the whole live view image will be enhanced.

3.14 Adjust Digital Zoom







You can zoom the image by using this function.

Press  in the view mode, and the digital zoom switches from 1× to 2×, 4×, 8×, and 16×.

3.15 Set OSD

You can choose whether to display the OSD information on the live view interface in this function.





Steps

1. Hold  to show the menu.
2. Select , and press  to enter the OSD setting interface.
3. Press  or  to select the OSD information you want to display or not.
4. Press  to enable or disable the selected OSD information.

3.16 Set Brand Logo

You can add brand logo on the live view interface.

Steps

1. Hold  to show the menu.
2. Select .
3. Press  to enable **Brand Logo**.
4. Hold  to save the settings and exit.

Result

The brand logo is displayed at the bottom left of the image.





Note

After enabling this function, the brand logo only displays on the live view interface, captures and videos.

Chapter 4 Burning Prevention

This function can prevent the detector of the thermal channel from being burned. When you enable this function, the shield will close if the grey scale of the detector reaches a certain value.

Steps

1. Hold  to show the menu.
2. Select  and press  to enable or disable the burn-prevention function.
3. Hold  to save settings and exit.





Note

When the burn-prevention function is disabled, the shield should be opened if it closes.

Chapter 5 Hot Tracking

The device can detect the highest temperature spot in the scene and mark it on display.

Steps

1. Hold  to show the menu.
2. Select  and press  to mark the spot of highest temperature.
3. Hold  to save settings and exit.

Result



When the function is enabled,  displays in the spot of highest temperature. When the scene changes, the  moves.



Figure 5-1 Hot Tracking Effect















Chapter 6 Measure Distance

The device can detect the distance between the target and the observation position with laser.

Before You Start

When measuring the distance, keep the hand and the position steady. Otherwise, the accuracy may be affected.

Steps

1. Hold  to show the menu.
2. Select , and press  to enter the laser ranging setting interface.
3. Press  to enable **Laser Ranging**.
4. Press  or  to select **Continuous**, and press  to start setting continuous distance measurement time.
5. Press  or  to switch the continuous distance measurement time, and press  confirm.
6. Hold  to return to the live view interface, and aim the cursor at the target..
7. Press  to measure target distance once, and hold  to measure target distance continuously.
 -  means measuring the distance continuously. The measurement result will be refreshed every 1 s.
 -  means measuring the distance once.

Result



The distance measurement result is displayed at the upper right of the image.



Figure 6-1 Laser Ranging Result

Chapter 7 Geographic Location Display

Equipped with satellite positioning modules, the device is able to display the longitude and latitude, as well as the sea level altitude of the device on the live image, captured images, and recorded videos.

In menu mode, select  and press  to enable the satellite positioning modules. You can see the location displayed at lower right corner of the screen.

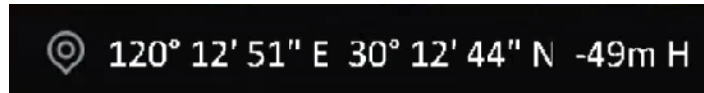



Figure 7-1 Location Display

 **Note**

- The satellite module is not able to receive signals when the device is indoor. Place the device in an empty outdoor space to receive signals.
 - In an outdoor space, wait for a moment for the device to display its location.
 - Location display is only supported by models with satellite positioning modules.
-

Chapter 8 Direction Display

Equipped with a compass, the device is able to display its direction on the live image, captured images, and recorded videos.

In menu mode, select  and press  to enable the compass modules, then follow the pop-up instructions to calibrate the compass. See [Calibrate Compass](#) for more information.

After successful calibration, you can see the direction displayed at up right corner of the screen. It is recommended to read the direction when you lay the device horizontally.

To increase the direction accuracy, you can set the magnetic declination correction. See [Magnetic Declination Correction](#) for instructions.

Note



The function is supported by certain models.

8.1 Calibrate Compass

Compass calibration is a must for correction direction display.

You need to calibrate the compass when you enable the function for the first time, or when the compass is magnetically interfered, and the direction information displays red.

Steps

1. Call the calibration guide by the following ways.
 - When you enable compass for the first time, the compass calibration guide pops up.
 - When the compass information displays red, select  in menu mode and press  to re-enable compass.
2. Follow the screen instructions to move and rotate the device.

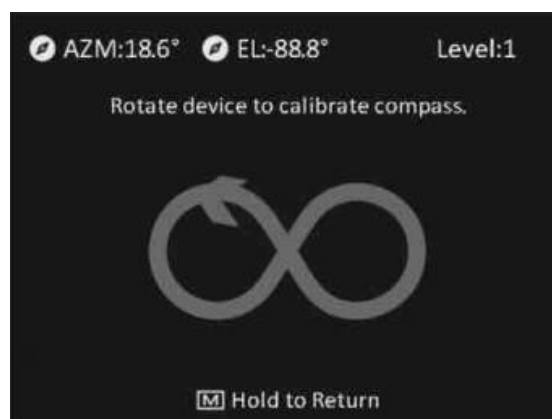

Note

- During calibration, keep moving and rotating the device to make sure that the device faces every possible directions.

- **Calibration Level** indicates the validity of calibration. Higher level means more accurate compass reading. Calibration succeeds when the **Calibration Level** turns to **3**.
-

3. Stop moving the device when calibration success message pops up.

Result

The direction information is displayed on the up right of the live view image.











Figure 8-1 Direction Display

8.2 Magnetic Declination Correction

Magnetic declination is the angle variation between magnetic north and true north. Adding the magnetic declination to the compass increase the accuracy of direction reading.

Steps

1. After the compass is calibrated, go to the compass setting interface, and press  or  to select **Magnetic Declination Correction**.
2. Press  or  to select **Quick Correction** or **Manual Correction**.
 - In quick correction, the device display the current declination to magnetic north. Point screen center to true north and press .
 - In manual correction, press  to select the operational symbol or number, and  or  to add or subtract the declination of device location.
3. Hold  to save and exit.

Chapter 9 Picture and Video

You can manually record video or capture picture when displaying live view.

9.1 Capture Picture

In live view mode, press  to capture picture.

Note

When capturing succeeds, the image freezes for 1 second and a prompt shows on the display. For exporting captured pictures, refer to **Export Files**.

9.2 Record Video

Steps

1. In live view mode, hold  and start recording.

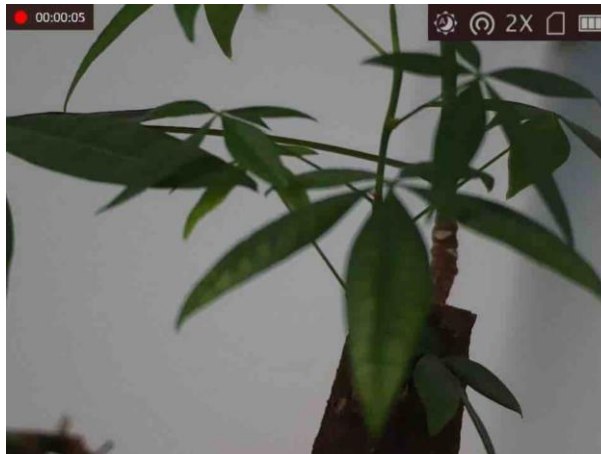



Figure 9-1 Start Recording

The left top of image displays the information of recording time.

2. Hold  again to stop recording.

What to do next





For exporting recording files, refer to **Export Files**.

9.3 Set Audio

If you enable the audio function, the sound will be recorded with the video. When there is too

loud noise in the video, you can disable this function.



Steps

1. Hold  to show the menu.
2. Select .
3. Press  to enable or disable this function.
4. Hold  to save and exit.

9.4 View Local Files







Captured images and recorded videos are automatically stored in the device, and you can view the files in local albums.

Steps





1. Hold  to go to the menu.
2. Select , and press  to enter **Albums**.

Note

The albums are automatically created and named by year + month. The local pictures and videos of a certain month are stored in the corresponding album. For example, the pictures and videos of August in 2022 are saved in the album named 202208.

2. Press  or  to select the album storing the files, and press  to enter the selected album.
3. Press  or  to select a file to view.
4. Press  to view the selected file and relevant information.

Note

- Files are arranged in chronological order, with the most recent at the top. If you fails to find the most recently taken snapshots or videos, please check the time and date settings of your device. See **12.1 Synchronize Time** for instructions. When you are viewing files, you can switch to other files by pressing  and , and turn pages by pressing .
- When you are viewing videos, you can press  to play or stop the video.
- For deleting an album or a file, you can hold  to call the dialogue box, and delete the album or file according to the prompt.
- For file exporting, see **Export Files** for instructions.

9.5 Export Files

This function is used to export recorded videos and captured pictures.

Before You Start

- Turn off hotspot function.
- Turn on the device after connecting it to your PC, and keep the device on for 10 to 15 seconds

before other operations.

- Remove batteries from the device before connecting to your PC, or it may cause device damage.

Steps

1. Connect the device and PC with cable.
-

Note

Make sure the device is turned on when connecting the cable.

2. Open computer disk and select the disk of device. Go to the **DCIM** folder and find the folder named after the capture year and month. For example, if you capture a picture or record a video on June 2021, go to **DCIM → 202106** to find the picture or video.
 3. Select and copy the files to PC.
 4. Disconnect the device from your PC.
-



Note

- The device displays images when you connect it to PC. But functions such as recording, capturing and hotspot are disabled.
 - When you connect the device to PC for the first time, it installs the drive program automatically.
-

Chapter 10 Client Software Connection

Connect the device to the HIKMICRO Sight App via hotspot, then you can capture picture, record video, or configure parameters on your phone.

Steps

1. Hold  to show the menu of device.
2. Press  to enable hotspot function.
3. Turn on the WLAN of your phone and connect to the hotspot.
 - Hotspot Name: HIK-IPTS Serial No.
 - Hotspot Password: Serial No.
4. Search the HIKMICRO Sight App on App Store (iOS System) or Google Play™ (Android System) to download it, or scan the QR code to download and install the app.



Android System



iOS System

5. Open the App and connect your phone with the device. You can view the interface of device on your phone.

Note

- The device cannot connect to the app if entering wrong password several times. Refer to **Restore Device** to reset the device, and connect the app again.
 - The device should be activated for the first use. The default password must be changed after the activation.
-



Chapter 11 CVBS Output

The CVBS output is used to debug the device. You can also view the device image on the display unit for details.

Before You Start

Connect the device to the display unit via CVBS interface of the aviation plug.

Steps

1. Hold  to show the menu.
2. Select , and press  to switch on CVBS.

Note











The CVBS cable is not included in the package, please purchase it by yourself.

Chapter 12 System Settings

You can set unit, time, and language for your device.

12.1 Synchronize Time





Steps

1. Hold  to show the menu.
2. Select , and press  to enter the time setting interface.
3. Press  to switch the time system, and press  or  to select the time and date to be synchronized.
4. Press  to select the hour, minute, second, year, month, or day to be synchronized, and press  or  again to change the number.
5. Hold  to save settings and exit.

12.2 Unit Settings

You can switch the unit for fusion level and laser ranging functions.







Steps

1. Hold  to show the menu.
2. Select , and press  to switch the unit. **Yard** and **m** (meter) are selectable.
3. Hold  to save settings and exit.

12.3 Language Settings

You can select the device language in this function.

Steps

1. Hold  to show the menu.
2. Select , and press  to enter the language configuration interface.
3. Press  or  to select the language as required, and press  to confirm.

Chapter 13 Maintenance

This part introduces the operation of checking device information, upgrading device, and restoring to defaults, etc.

13.1 View Device Information

Steps

1. Hold  to show the menu of device.
2. Select , and press . You can view the device information such as version, and serial No.

13.2 Upgrade Device

Before You Start

- Please get the upgrade package (including Main Firmware and FPGA Firmware) first.
- Make sure the hotspot function is disabled.
- Remove batteries from the device before connecting to your PC.
- Turn on the device after connecting it to your PC, and keep the device on for 10 to 15 seconds before other operations.

Steps

1. Connect the device to your PC with cable, and then turn on the device.
2. Open the detected disk, copy the upgrade file and paste it to the root directory of the device.
3. Hold  to reboot the device, and the device upgrades automatically. The upgrading process will be displayed in the main interface.



Note

During the upgrade, make sure the device is connected to your PC. Otherwise, it may cause unnecessary upgrade failure, firmware damage, etc.

4. Repeat the above steps to upgrade all firmwares one by one.

13.3 Restore Device

Steps

1. Hold  to show the menu of device.
2. Select , and press  to restore the device to defaults according to the prompt.

Chapter 14 Frequently Asked Questions

14.1 Why is the monitor off?

Check whether the device is off-battery. Check the monitor after charging the device for 5 minutes.

14.2 The image is not clear, how to adjust it?

Adjust the diopter adjustment knob until the image is clear. Refer to section [3.1 Adjust Diopter](#).

14.3 Capturing or recording fails. What's the problem?

Check the following items.

- Whether the device is connected to your PC. Capturing or recording is disabled in this status.
- Whether the storage space is full.
- Whether the device is low-battery.

14.4 Why the PC cannot identify the device?

Check the following items.

- Whether the device is connected to your PC with supplied USB cable.
- If you use other USB cables, make sure the cable length is no longer than 1 m.

Chapter 15 Appendix

15.1 Device Command

Scan the following QR code to get device common serial port commands.

Note that the command list contains the commonly used serial port commands for HIKMICRO thermal cameras.



15.2 Device Communication Matrix

Scan the following QR code to get device communication matrix.

Note that the matrix contains all communication ports of HIKMICRO thermal cameras.





HIKMICRO

See the World in a New Way



Facebook: HIKMICRO Outdoor Instagram: hikmicro_outdoor

YouTube: HIKMICRO Outdoor

LinkedIn: HIKMICRO