



POCKET

Thermal Camera User Manual



Contact Us

SAFETY INSTRUCTION

Technical Support

The <https://www.hikmicrotech.com/en/contact-us.html> portal will help you as a HIKMICRO customer to get the most out of your HIKMICRO products. The portal gives you access to our support team, software and documentation, service contacts, etc.

Calibration Service

We recommend you send the device back for calibration once a year, and please contact the local dealer for the information on maintenance points. For more detailed calibration services, please refer to <https://www.hikmicrotech.com/en/calibrationservices/2>.

Battery

- ◆ CAUTION: Risk of explosion if the battery is replaced by an incorrect type. Replace with the same or equivalent type only. Dispose of used batteries in conformance with the instructions provided by the battery manufacturer.
- ◆ Improper replacement of the battery with an incorrect type may defeat a safeguard (for example, in the case of some lithium battery types).
- ◆ Do not dispose of the battery into fire or a hot oven, or mechanically crush or cut the battery, which may result in an explosion.
- ◆ Do not leave the battery in an extremely high temperature surrounding environment, which may result in an explosion or the leakage of flammable liquid or gas.
- ◆ Do not subject the battery to extremely low air pressure, which may result in an explosion or the leakage of flammable liquid or gas.
- ◆ Dispose of used batteries in conformance with the instructions provided by the battery manufacturer.
- ◆ The built-in battery cannot be dismantled. Please contact the manufacture for repair if necessary.
- ◆ For long-term storage of the battery, make sure it is fully charged every half year to ensure the battery quality. Otherwise, damage may occur.
- ◆ Use the battery provided by a qualified manufacturer. Refer to the product specification for detailed battery requirements.
- ◆ DO NOT charge other battery types with the supplied charger. Confirm there is no flammable material within 2 m of the charger during charging.
- ◆ DO NOT place the battery near heating or fire source. Avoid direct sunlight.
- ◆ DO NOT swallow the battery to avoid chemical burns.
- ◆ DO NOT place the battery in the reach of children.
- ◆ When the device is powered off and the RTC battery is full, the time settings can be kept for 6 months.

- ◆ In the first use, charge the device for more than 2.5 hours in the power-off status.
- ◆ The lithium battery voltage is 3.85 V, and the battery capacity is 2100 mAh.
- ◆ The battery is certified by UL2054.

Power Supply

- ◆ Input voltage should meet the Limited Power Source (3.85 VDC, 570 mA) according to the IEC62368 standard. Please refer to technical specifications for detailed information.
- ◆ Make sure the plug is properly connected to the power socket.
- ◆ DO NOT connect multiple devices to one power adapter, to avoid over-heating or fire hazards caused by overload.
- ◆ Use the power adapter provided by a qualified manufacturer. Refer to the product specification for detailed power requirements.

Maintenance

- ◆ If the product does not work properly, please contact your dealer or the nearest service center. We shall not assume any responsibility for problems caused by unauthorized repair or maintenance.
- ◆ Wipe the device gently with a clean cloth and a small quantity of ethanol, if necessary.
- ◆ If the equipment is used in a manner not specified by the manufacturer, the protection provided by the device may be impaired.
- ◆ Please notice that the current limit of USB 3.0 PowerShare port may vary with the PC brand, which is likely to result in incompatibility issue. Therefore, it's advised to use regular USB 3.0 or USB 2.0 port if the USB device fails to be recognized by PC via USB 3.0 PowerShare port.
- ◆ Your camera will periodically perform a self-calibration to optimize image quality and measurement accuracy. In this process, the image will pause briefly and you will hear a "click" as a shutter moves in front of the detector. The self-calibration will be more frequent during start up or in very cold or hot environments. This is a normal part of operation to ensure optimum performance for your camera.



Using Environment

- ◆ Make sure the running environment meets the requirement of the device. The operating temperature shall be -10 °C to 50 °C (14 °F to 122 °F), and the operating humidity shall be 95% or less.
- ◆ Place the device in a dry and well-ventilated environment.
- ◆ DO NOT expose the device to high electromagnetic radiation or dusty environments.
- ◆ DO NOT aim the lens at the sun or any other bright light.
- ◆ When any laser equipment is in use, make sure that the device lens is not exposed to the laser beam, or it may burn out.
- ◆ DO NOT aim the lens at the sun or any other bright light.

- ◆ The device is suitable for indoor and outdoor uses, but do not expose it in wet conditions.
- ◆ The level of protection is IP 54.
- ◆ The pollution degree is 2.

Symbol Conventions

The symbols that may be found in this document are defined as follows.

<i>Symbol</i>	<i>Description</i>
 Danger	Indicates a hazardous situation which, if not avoided, will or could result in death or serious injury.
 Caution	Indicates a potentially hazardous situation which, if not avoided, could result in equipment damage, data loss, performance degradation, or unexpected results.
 Note	Provides additional information to emphasize or supplement important points of the main text.

These instructions are intended to ensure that user can use the product correctly to avoid danger or property loss. Please read all the safety information carefully before using.

Laws and Regulations

- ◆ Use of the product must be in strict compliance with the local electrical safety regulations.

Transportation

- ◆ Keep the device in original or similar packaging while transporting it.
- ◆ Keep all wrappers after unpacking them for future use. In case of any failure occurred, you need to return the device to the factory with the original wrapper. Transportation without the original wrapper may result in damage on the device and the company shall not take any responsibilities.
- ◆ DO NOT drop the product or subject it to physical shock. Keep the device away from magnetic interference.

Emergency

- ◆ If smoke, odor, or noise arises from the device, immediately turn off the power, unplug the power cable, and contact the service center.

Manufacture Address

Room 313, Unit B, Building 2, 399 Danfeng Road, Xixing Subdistrict, Binjiang District, Hangzhou, Zhejiang 310052, China

Hangzhou Microimage Software Co., Ltd.

COMPLIANCE NOTICE

The thermal series products might be subject to export controls in various countries or regions, including without limitation, the United States, European Union, United Kingdom and/or other member countries of the Wassenaar Arrangement. Please consult your professional legal or compliance expert or local government authorities for any necessary export license requirements if you intend to transfer, export, re-export the thermal series products between different countries.

CONTENTS

Chapter 1 Overview	1
1.1 Important Notice to User	1
1.2 Device Description.....	1
1.3 Main Function	1
1.4 Appearance	2
Chapter 2 Preparation	4
2.1 Charge Device	4
2.2 Power On/Off	4
2.2.1 Manual Sleep	4
2.2.2 Set Auto Power-Off.....	4
2.3 Operation Method.....	5
2.4 Menu Description	5
Chapter 3 Display Settings	7
3.1 Set Screen Brightness.....	7
3.2 Set SuperIR.....	7
3.3 Set Image Mode	7
3.3.1 Set Parallax Correction	8
3.4 Set Palettes.....	9
3.5 Adjust Level & Span.....	9
3.6 Color Distribution.....	10
3.7 Adjust Digital Zoom.....	10
3.8 Display On-Screen Info.....	11
Chapter 4 Temperature Measurement.....	12
4.1 Set Temperature Measurement Parameters	12
4.2 Set Measurement Tools.....	12

4.3 Set Temperature Alarm.....	13
Chapter 5 Picture and Video.....	14
5.1 Capture Picture.....	14
5.2 Record Video.....	15
5.3 Manage Albums.....	15
5.4 View Recorded Files.....	16
5.5 Manage Files.....	17
5.6 Export Files	18
5.6.1 Export via HIKMICRO Viewer (If Applicable)	18
5.6.2 Export via PC.....	18
Chapter 6 Device Connections.....	19
6.1 Pair Bluetooth Devices.....	19
6.2 Cast Device Screen to PC	19
6.3 Connect Device to Wi-Fi (If Applicable)	19
6.4 Set Device Hotspot and Join (If Applicable)	20
Chapter 7 Mobile Client Connection	21
7.1 Connect via Wi-Fi.....	21
7.2 Connect via Hotspot.....	21
Chapter 8 System Settings.....	23
8.1 Set Macro Mode	23
8.2 Set Time and Date	23
8.3 Set Unit.....	23
8.4 Set Language	23
8.5 Set Auto-Rotation	24
Chapter 9 Maintenance	25
9.1 View Device Information.....	25
9.2 Upgrade Device.....	25

9.3 Restore Device	25
9.4 Save Operation logs	25
9.5 Format Storage.....	26
9.6 About Calibration.....	26
Chapter 10 FAQ.....	27
10.1 Frequently Asked Questions (FAQ).....	27

CHAPTER 1 OVERVIEW

1.1 Important Notice to User

This manual describes and explains the features for multiple camera models. Because the camera models of a series have different features, this manual may contain descriptions and explanations that do not apply to your particular camera model.

Not all the camera models of a series support the mobile applications, software, and all their functions mentioned (or not mentioned) in this manual. Please refer to the user manuals of the application and software for more detailed information.

This manual is updated on a regular basis. It means that this manual may not contain the information about the new features of the latest firmware, mobile clients, and software.

1.2 Device Description

The pocket thermography camera is a device with both visual images and thermal images. It can do temperature measurement, video recording, snapshot capturing, alarm, and it can connect to Wi-Fi, hotspot and Bluetooth. The built-in high-sensitivity IR detector and high-performance sensor detects the variation of temperature and measure the real-time temperature.

The device is easy to use, and adopts ergonomic design. It is widely used for building inspection, HVAC, as well as electrical and mechanical equipment maintenance.

1.3 Main Function

Temperature Measurement

The camera detects the real-time temperature, and displays it on the screen.

Fusion

The camera can display fusion of thermal view and visual view.

Palettes

The camera supports multiple color palettes for different targets and user preference.

Alarm

The camera supports temperature alarms.

SuperIR

The camera supports **SuperIR** to enhance object outlines. Some camera models can

display the real-time SuperIR image in live view.

Client Software Connection (If Applicable)



If your particular model supports **Wi-Fi** and **Hotspot**, scan the QR code to download the HIKMICRO Viewer App for live view, capture snapshots, record videos, etc.

Download HIKMICRO Analyzer (<https://www.hikmicrotech.com/en/industrial-products/hikmicro-analyzer-software.html>) to your PC for analyzing files.

Bluetooth

Device can be connected to headset via Bluetooth, and you can hear the voice in the recording.

1.4 Appearance

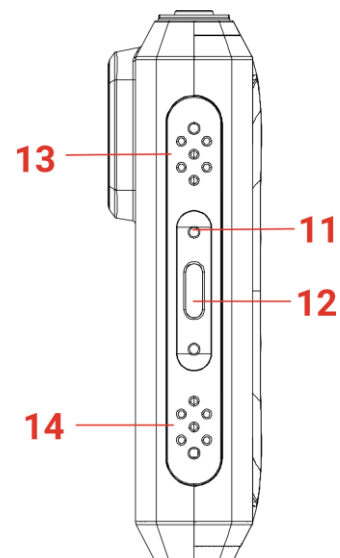
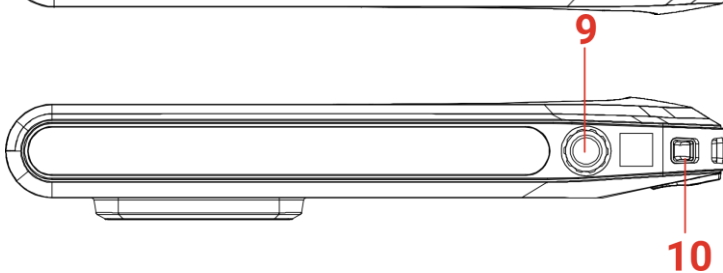
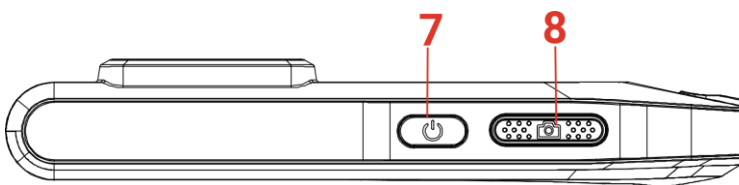
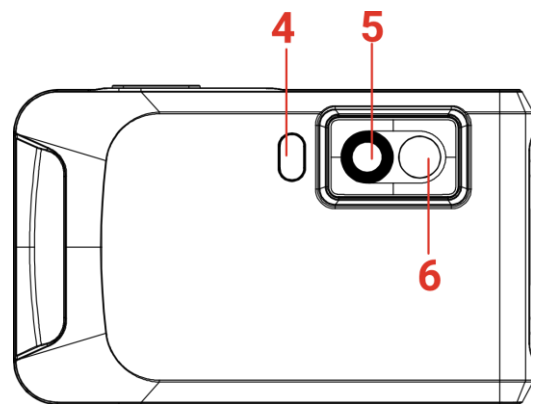
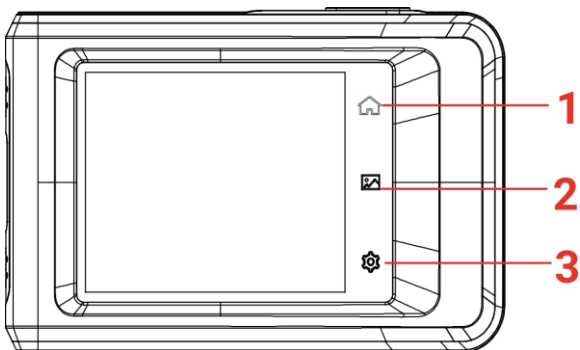

No.	Description	Function
1	Home Key	Tap to return to the live view interface.
2	File Key	Tap to enter albums.
3	Settings Key	Tap to enter settings interface.
4	Flash Light	Fill light on objects and output flashing alarm.
5	Thermal Lens	View the thermal image.
6	Visual Lens	View the visual image.
7	Power Key	<ul style="list-style-type: none"> ◆ Hold: Power on/off the device. ◆ Press: Manual sleep/Wake up the device.
8	Capture Key	<p>In live view:</p> <ul style="list-style-type: none"> ◆ Press: Capture snapshots/stop recording. ◆ Hold: Start recording. <p>In menu mode: Return to the live view interface.</p>
9	Tripod Mount	Mount the tripod.
10	Strap Attachment Point	Mount the strap.
11	Indicator	<p>Indicate the charging status of the device.</p> <ul style="list-style-type: none"> ◆ Solid red: charging normally ◆ Flashing red: charging exception ◆ Solid green: fully charged
12	Type-C Interface	Charge the device or export files with the supplied USB cable.
13	Buzzer	Output audible alarm.
14	Microphone	Record audio.

**NOTE**

Your camera will periodically perform a self-calibration to optimize image quality and measurement accuracy. In this process, the image will pause briefly and you'll hear a "click" as a shutter moves in front of the detector. The prompt "Image Calibrating ..." appears in the upper center of the screen as the device is calibrating itself. The self-calibration will be more frequent during start up or in very cold or hot environments.

CHAPTER 2 PREPARATION

2.1 Charge Device

The camera is equipped with a built-in battery. It is recommended to charge the camera with the included USB cable in the package and the Type-C interface on camera. Do not use the USB-C to USB-C cable of other manufacturers.

The power adapter (not included) should meet the following standards:

- ◆ Output Voltage/Current: 5 VDC/2 A
- ◆ Minimum Power Output: 10 W

Check the power indicator for the charging status:

- ◆ Solid red: charging normally
- ◆ Flashing red: charging exception
- ◆ Solid green: fully charged

**NOTE**

- ◆ If the camera is not in use for an extended period and is over-discharged, it is recommended to charge for at least 30 min before powering it on.
- ◆ It is recommended to use the USB cable included in the package for both charging and data transfer.

2.2 Power On/Off

Power On

Hold  for over three seconds to turn on the device. You can observe the target when the interface of the device is stable.



**NOTE**

- It may take at least 30 s until the device is ready for using after you power on it.

Power Off

When the device is turned on, hold  for about three seconds to power off the device.

2.2.1 Manual Sleep

When the device is turned on, press  once to turn on the sleep mode, and press  again to wake up the device.

2.2.2 Set Auto Power-Off

Tap , and go to **Device Settings > Auto Power-off** to set the automatic shutdown time

for device as required.

2.3 Operation Method

The device supports touch-screen control. You can tap the screen to set parameters and configurations.

2.4 Menu Description

Live View

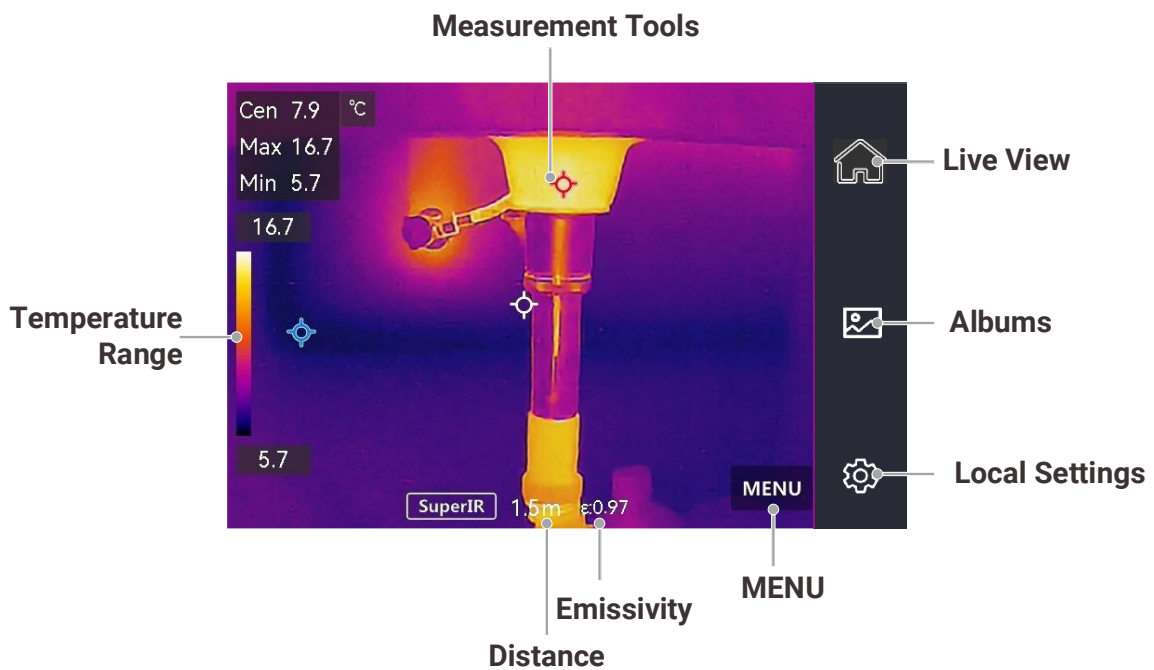

Swipe-down Menu

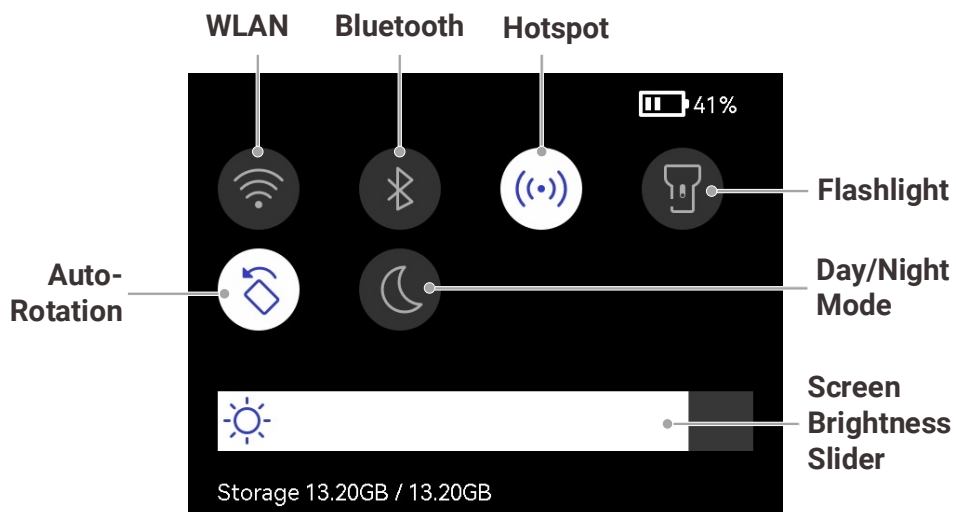



NOTE

Because this manual is updated on a regular basis, the interfaces might be slightly different from the version of your particular camera model. Please refer to the actual camera.

CHAPTER 3 DISPLAY SETTINGS

3.1 Set Screen Brightness

Go to **Local Settings** > **Device Settings** > **Screen Brightness** to adjust the screen brightness. Or tap , and drag it to adjust the screen brightness.

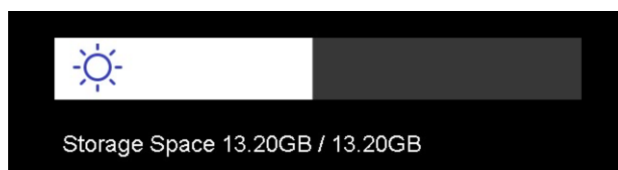

3.2 Set SuperIR

The device supports **SuperIR** on live view (for some models) and on snapshots. Turn on **SuperIR** to enhance the object outlines for better image display. The actual effect is subject to the actual product.

Go to **Local Settings** > **Capture Settings** > **SuperIR** to turn it on/off.

- ◆ On live view: For some models, the object outlines can be enhanced in live view when SuperIR is on.
- ◆ On captured images: the object outlines in the image are enhanced after SuperIR is on.

3.3 Set Image Mode

You can set the thermal/visual view of the device. **Thermal**, **Fusion**, **PIP**, **Blending**, and **Visual** are selectable.

1. Tap **MENU**, and select .
2. Tap the icons to select an image mode.







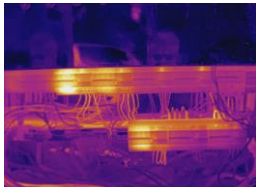

<i>Image Mode</i>	<i>Description</i>	<i>Example</i>
 Thermal	In thermal mode, the device displays the thermal view.	

Image Mode	Description	Example
 Fusion	Thermal object image with visual outlines. Adjust Parallax Correction in live view to improve image alignment.	
 PIP	In PIP (Picture in Picture) mode, the device displays thermal view inside the visual view. You can adjust the size, parallax correction and digital zoom of the PIP.	
 Blending	In Blending mode, the device displays the mixture view of thermal channel and visual channel. You can select the visual-thermal Level to change the visual-thermal ratio.	
 Visual	Visual object image only.	

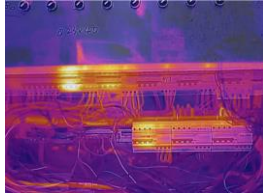
3. Tap **BACK** to exit.

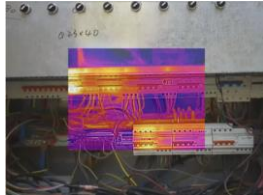
3.3.1 Set Parallax Correction

You should set the parallax correction after you set the image mode as **Fusion**, **PIP**, or **Blending**, so as to improve the thermal-visual image alignment.

Tap on the screen to show the adjustment interface, select **Parallax Correction** (xx m), and scroll the value wheel to set the value.

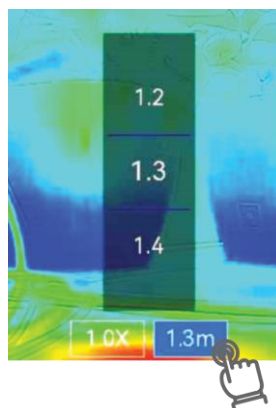

3.4 Set Palettes

The palettes allow you to select the desired colors.

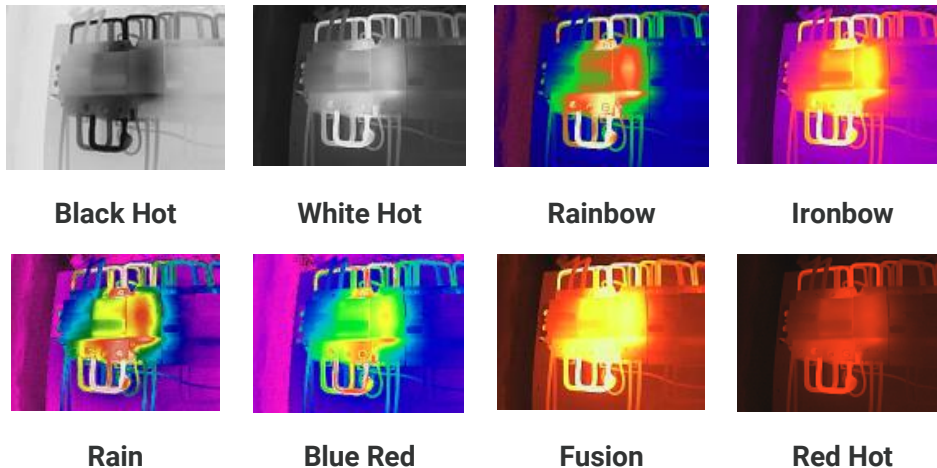

1. Tap **MENU**, and select .
2. Tap the icons to select a palette.





3. Tap **BACK** to exit the setting interface.

3.5 Adjust Level & Span

Set a display temperature range and the palette only works for targets within the range. You can adjust the display temperature range.

1. Tap **MENU**, and select .
2. Select auto adjustment  or manual adjustment .

	Auto	Select  . The device adjusts display temperature range parameters automatically.
	Manual	<ol style="list-style-type: none"> 1) Tap on an interest area of the screen. A circle is displayed around the area, and the display temperature range readjusts to show as many details of the area as possible. 2) Tap on the value on screen to lock or unlock a value. 3) Scroll the adjustment wheel on the screen to fine-tune the max. temperature and the min. temperature respectively. 4) Tap OK to finish.

3. Tap **BACK** to exit.

3.6 Color Distribution

Color distribution function provides different image display effects in auto level & span. Linear and histogram color distribution modes can be selected for different application scenes.

1. Go to **Local Settings > Temp Measurement Settings >Color Distribution.**
2. Select a color distribution mode.

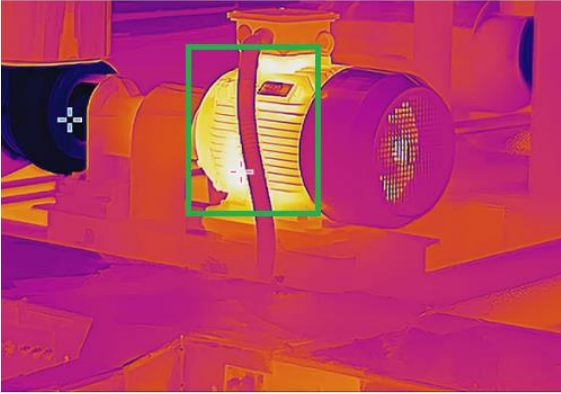
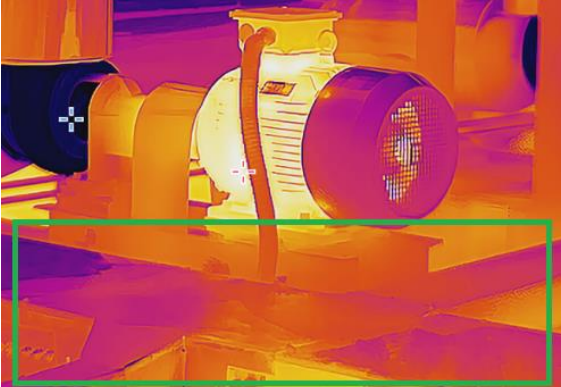
Mode	Description	Example
Linear	Linear mode is used to detect small high temperature targets in low temperature background. Linear color distribution enhances and displays more details of high temperature targets, which is good for checking small high temperature defective areas such as cable connectors.	
Histogram	Histogram mode is used to detect temperature distribution in large areas. Histogram color distribution enhances high temperature targets and remains some details of low temperature objects in the area, which is good for discovering small low temperature targets such as cracks.	

3. Tap < to save and exit.

 **NOTE** This function is only supported in  auto level & span.

3.7 Adjust Digital Zoom

1. Tap the live view interface to call the digital zoom frame.
2. Tap the digital zoom frame.
3. Select the digital zoom value as required
4. Tap the screen to save and exit.

3.8 Display On-Screen Info

Go to **Local Settings** > **Display Settings** to enable the information on-screen display.

- ◆ **Time and Date:** Device time and date.
- ◆ **Parameters:** Temperature measurement parameters, for example, target emissivity, temperature unit, etc.
- ◆ **Brand Logo:** The brand logo is a manufacturer logo overlapped on images.

CHAPTER 4 TEMPERATURE MEASUREMENT

The temperature measurement function provides the real-time temperature of the scene. The device displays the measurement results on the left of your screen. This function is turned on by default.

4.1 Set Temperature Measurement Parameters

You can set temperature measurement parameters to improve the accuracy of temperature measurement.





1. Go to **Local Settings > Temp Measurement Settings**.
2. Set the Temperature Range, Emissivity, etc.
 - ◆ **Temperature Range**: Select the temperature measurement range. The device can detect the temperature and switch temperature measurement range automatically in Auto Switch mode.
 - ◆ **Emissivity**: Set the emissivity according to your target. You can customize it or select a recommended value.
 - ◆ **Refl. Temp.**: Reflected temperature. If any object (not the target) of high temperature is in the scene, and the target emissivity is low, set the reflection temperature as the high temperature to correct the temperature measurement effect.
 - ◆ **Distance**: The distance between the target and the device. You can customize the target distance or select the target distance as **Near, Middle, or Far**.
 - ◆ **Humidity**: Set the relative humidity of current environment.
3. Return to previous menu to save the settings.

**NOTE**

You can go to **Local Settings > Device Settings > Device Initialization > Remove All Measurement Tools** to initialize the temperature measurement parameters.

4.2 Set Measurement Tools

You can set measurement tools to measure the min., max., and center temperatures of the current scene.

1. Tap **MENU**, and select .
2. Tap to select the temperature measurement tool as required. **Hot** , **Cold** , and **Center**  are selectable.
3. Tap **BACK** to save and exit.

 **NOTE** The min., max., and center temperatures are displayed on the left top of the screen. Tap the tool again to delete.

4.3 Set Temperature Alarm

When the temperature of targets triggers the set alarm rule, the device will perform configured actions, such as making audible warning and flash alarm.

1. Go to **Local Settings > Temp Measurement Settings > Alarm Settings**.
2. Enable **Temperature Alarm** and set the alarm parameters.

Alarm Threshold	When the tested temperature exceeds the threshold, the device sends alarm notification to the client software. The device will buzz if the audible warning is enabled, and the flashlight will flash if the flashing alarm is enabled.
Alarm Linkage	<ul style="list-style-type: none"> ◆ Audible Warning: The device beeps when target temperature exceeds the alarm threshold. ◆ Flashing Alarm: The flash light flashes when target temperature exceeds the alarm threshold.

3. Tap < to save and exit.

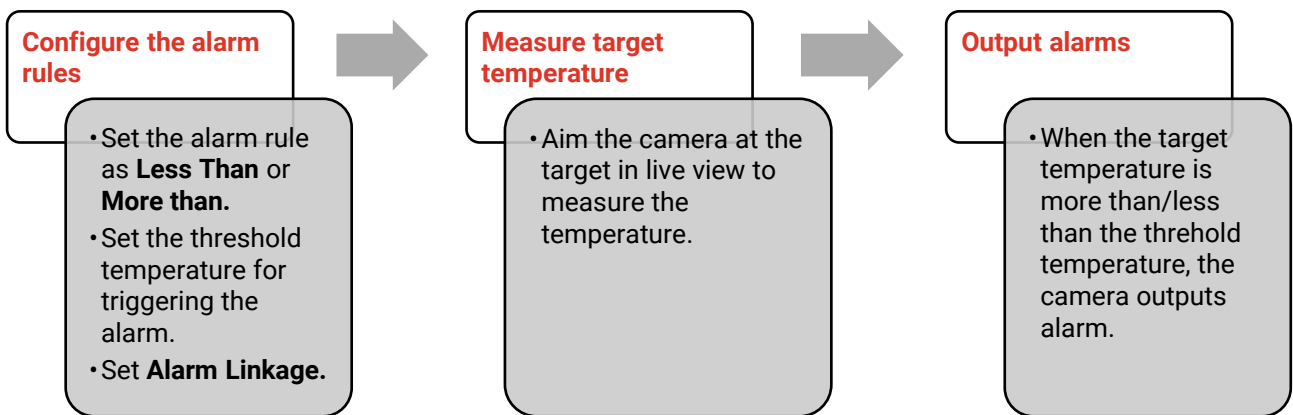



CHAPTER 5 PICTURE AND VIDEO

The device can record videos and capture snapshots. The files are saved in the local albums.







NOTE

- ◆ The device does not support capturing or recording when the menu is shown.
- ◆ When the device is connected to your PC, it does not support capturing or recording.
- ◆ Tap  and go to Local Settings > Capture Settings > Filename Header, you can set the filename header for capturing or recording to distinguish the files recorded in a specific scene.
- ◆ Tap  and go to Local Settings > Device Settings > Device Initialization to initialize the storage as needed.

5.1 Capture Picture

In live view, press  to capture a snapshot. Enable the flashlight via the swipe-down menu in dark environment.

You can also set the following parameters in **Local Settings > Capture Settings** as needed.

Parameters	Description
Capture Mode	<ul style="list-style-type: none"> ◆ Capture One Image: Press  once to capture one image. ◆ Scheduled Capture: Set Interval (the time interval of each snapshot to be taken) and Number (the number of snapshots to be taken in a roll, ranging from 1 to 10,000) for scheduled capture. Press  in live view, and the camera captures the set number of images according to the set interval. Press  again to stop capturing.
Edit before Saving	<p>In Capture One Image mode, if you need to edit the captured image immediately, enable Edit before Saving.</p> <ul style="list-style-type: none"> ◆ Text Note: Select text note and enter the editing page. Tap on screen to input content and press  to save. ◆ Scan QR Code: <ol style="list-style-type: none"> 1) Select QR code and the device enters the scanning mode. 2) Aim the scanning frame at a QR code. Device reads the code and save the code information. 3) Optional: If the scanning fails, you can enter the code information (Asset ID) using on-screen keyboard according to the prompt.

<i>Parameters</i>	<i>Description</i>
Filename Header	Set the naming rule for the saved files. The default image naming is filename header + saving time. Filename Header is configurable. Saving time is the device system time when the saving occurs.
SuperIR	Enable SuperIR before capturing to enhance the object outlines of the captured images.
File Naming	The files can be named after Time Stamp or Numbering (filename header + sequence number).
Save Visual Image	If a visual image is needed to be saved separately, enable Save Visual Image and set Visual Image Resolution .



**NOTE**

- ◆ For **Capture One Image**, if **Edit before Saving** is NOT enabled, the live image freezes and is saved in the default saving album. If **Edit before Saving** is enabled, the device enters the image editing interface.
- ◆ For **Scheduled Capture**, a counter displays in live view showing the completed amounts of capturing.

What to do next















- ◆ Tap  to enter albums to view and manage files and albums. See **5.3 Manage Albums** and **5.5 Manage Files** for operation instructions.
- ◆ You can connect your device to PC to export local files in albums for further use. See **5.6 Export Files**.

5.2 Record Video



1. In the live view interface, hold  to start recording. The recording icon and count down number display in the interface.
2. When you finish, press  once to stop recording. The recording video will be saved automatically.
3. **Optional:** Go to **Local Settings > Capture Settings**, you can choose a video type from MP4 (.mp4) and radiometric video (.hrv).

5.3 Manage Albums

The recorded image/video files are saved in the albums. You can create new albums, rename an album, change the default album, move files between the albums, and delete albums.

Task	Operations
Create a New Album	<ol style="list-style-type: none"> 1) Tap  to enter Albums. 2) Tap  to add a new album. 3) A soft keyboard is displayed, where you can enter the name of the album by touching the screen. 4) Tap  to finish. <div data-bbox="576 546 1430 656" style="border: 1px dashed gray; padding: 5px;">  NOTE The newly created album becomes the default saving album and appears at the top of the album list. </div>
Rename an Album	<ol style="list-style-type: none"> 1) Tap  to enter Albums. 2) Select the album to rename. 3) Tap , and select Rename. A soft keyboard is displayed. 4) Tap  to delete the old name, and enter the new name for the album by touching the screen. 5) Tap  to finish.
Change the Default Saving Album	<ol style="list-style-type: none"> 1) Tap  to enter Albums. 2) Select the album you want to use as the default saving album. 3) Tap , and select Set as Default Saving Album. <div data-bbox="576 1173 1430 1252" style="border: 1px dashed gray; padding: 5px;">  NOTE Default saving album appears at the top of the album list. </div>
Delete an Album	<ol style="list-style-type: none"> 1) Tap  to enter Albums. 2) Select the album you want to delete. 3) Tap , and select Delete. A prompt box appears on the interface. 4) Tap OK to delete the album. <div data-bbox="576 1516 1430 1657" style="border: 1px dashed gray; padding: 5px;">  NOTE The files in an album are deleted as well when deleting the album. Move the files to other albums if they are still needed. See 5.5 Manage Files for instructions. </div>

5.4 View Recorded Files

1. Tap  to enter **Albums**.
2. Tap to select the target album.
3. Tap to select a video or snapshot to open it.
4. Tap the image or video, and tap  to view more information.

**NOTE**

- ◆ Files are arranged in chronological order, with the most recent at the top. If you fails to find the most recently taken snapshots or videos, please check the time and date settings of your device. See **8.2 Set Time and Date** for instructions. When you are viewing files, you can switch to other files by tapping < or >.
- ◆ For more information contained in capture snapshots or videos, you can download and install the PC analyzing tool to analyze them.

5.5 Manage Files



You can move, delete, edit the recorded files, and add text notes to the files.

Task	Operations
Delete a File	<ol style="list-style-type: none"> 1) Tap to enter Albums. 2) Tap to select the album storing the file to be deleted. 3) In the album, tap to view the file to be deleted. 4) Tap the screen to show the menu bar below, and tap . A prompt box appears on the interface. 5) Tap OK to delete the file.
Delete Multiple Files	<ol style="list-style-type: none"> 1) Tap to enter Albums. 2) Tap to select the album storing the files to be deleted. 3) In the album, tap , and tap the files to be deleted. 4) Tap . A prompt box appears on the interface. 5) Tap OK to delete the files.
Move a File	<ol style="list-style-type: none"> 1) Tap to enter Albums. 2) Tap to select the album storing the file to be moved. 3) In the album, tap to view the file to be moved. 4) Tap the file to show the menu bar below, and select . The album list is displayed. 5) Tap to select the album to move to.
Move Multiple Files	<ol style="list-style-type: none"> 1) Tap to enter Albums. 2) Tap to select the album storing the files to be moved. 3) In the album, tap to select the files to be moved. 4) Tap . The album list is displayed. 5) Tap to select the album to move to.
Add Text Note on File	<ol style="list-style-type: none"> 1) Tap to enter Albums. 2) Tap to select the album storing the file to be edited. 3) In the album, tap to view the file to be edited. 4) Tap the screen to show the menu bar below, and tap . A soft keyboard is displayed. 5) Enter the text note by touching the screen. 6) Tap to finish.

Task**Operations****What to do next**

You can open the edited photo to view the text note.

**NOTE**

You can tap  to select all files, and tap  to cancel the selection.

5.6 Export Files

5.6.1 Export via HIKMICRO Viewer (If Applicable)

1. Launch HIKMICRO Viewer and add the device. Refer to *Chapter 7 Mobile Client Connection*.
2. Select **On-Device Files** on the app to access the on-device albums.
3. Select a file, and tap **Download** to save to your local albums.

5.6.2 Export via PC

1. Connect the device to your PC with the supplied USB cable, and select **USB Drive** mode in the prompt on device. In **USB Drive** mode, casting screen is not supported.
2. Open the detected disk, copy and paste the videos or snapshots to PC to view the files.
3. Disconnect the device from your PC.



**NOTE**

For the first connection, the driver will be installed automatically.

CHAPTER 6 DEVICE CONNECTIONS

6.1 Pair Bluetooth Devices

You can record and hear the sound contained in the videos via Bluetooth headsets, after pairing successfully.

1. Go to **Local Settings > Connections > Bluetooth**.
2. Tap  to enable Bluetooth. You can also tap  to quit pairing. The camera will search the nearby enabled Bluetooth headset and pair it automatically.

6.2 Cast Device Screen to PC

The device supports casting screen to PC by UVC protocol-based client software or player. You can connect the device to your PC via the included USB cable, and cast the real-time live view of the device to your PC.

1. Download the UVC protocol-based client software from our official website:
 <https://www.hikmicrotech.com/en/industrial-products/uvc-client/>
2. Connect the device to your PC via the included USB cable, and select **USB Cast Screen** in the prompt on the device as the USB mode. Exporting files via USB connection is not allowed when you are casting the screen.
3. Open UVC Alarm Client on your PC.

6.3 Connect Device to Wi-Fi (If Applicable)

If your camera model supports Wi-Fi, you can connect the camera to Wi-Fi network and add it to the mobile application.



1. Go to **Local Settings > Connections > WLAN**.
2. Tap  to enable Wi-Fi, and the searched Wi-Fi will be listed.
3. Select the Wi-Fi to connect to. A soft keyboard is displayed.
4. Enter the password by touching the screen.

**NOTE**

- ◆ DO NOT tap **space** in your password, or the password may be incorrect.
- ◆ Please tap  to enter password into the password field.

5. Tap  to save and connect Wi-Fi.

6.4 Set Device Hotspot and Join (If Applicable)

1. Go to **Local Settings > Connections > Hotspot**.
2. Tap  to enable the hotspot function. The hotspot name is the last 9 digits of the device serial No.
3. Set the device's hotspot and join it with your phone.
 - ◆ **Using hotspot password:**
 - 1) Tap **Set Hotspot**. A soft keyboard is displayed.
 - 2) Set the password for the hotspot by tapping the screen.
 - 3) Tap  to finish.
 - 4) Enable the Wi-Fi function of other equipment and search the device hotspot to join.
 - ◆ **Using hotspot QR code:** Scan the QR code with HIKMICRO Viewer to join the hotspot.

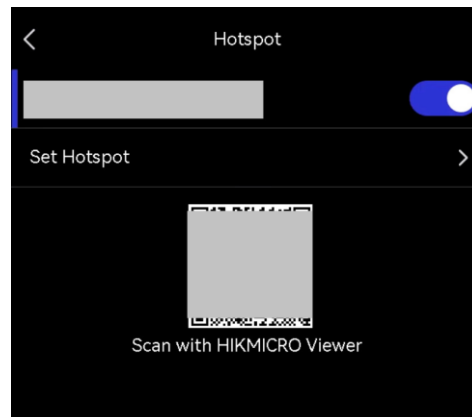
**NOTE**

- ◆ DO NOT tap **space** in your password, or the password may be incorrect.
- ◆ The password should at least contain 8 digits, consisting of numbers and characters.
- ◆ Please tap  to enter password into the password field.

4. Tap  to save.

CHAPTER 7 MOBILE CLIENT CONNECTION

For the camera models that support both **Wi-Fi** and **hotspot**, connect the camera to HIKMICRO Viewer, and you can control the device via mobile application.

7.1 Connect via Wi-Fi

Before You Start

Download and install HIKMICRO Viewer on your phone.

1. Connect your device to a Wi-Fi network. See **6.3 Connect Device to Wi-Fi** for instructions.
2. Add the device to the app.
 - ◆ Using Wi-Fi password.
 - 1) Enter password on phone to join the same Wi-Fi network.
 - 2) Launch the app and follow the startup wizard to create, and register an account.
 - 3) Search and add the device to the app.
 - ◆ Scanning the Wi-Fi QR code.
 - 1) Tap  next to the joined Wi-Fi on device to show the Wi-Fi QR code.
 - 2) Launch the app to scan to join the same Wi-Fi and add the device.

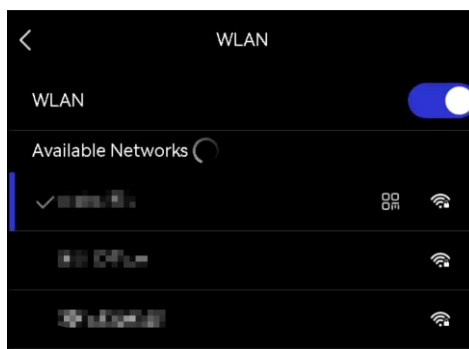

Result

You can view the live view, capture snapshots, and record videos via the app.

7.2 Connect via Hotspot

Before You Start

Download and install HIKMICRO Viewer on your phone.

1. Turn on the device hotspot and complete hotspot settings. See **6.4 Set Device Hotspot and Join** for instructions.

2. Connect your phone to the hotspot of the device.
3. Launch the app and follow the startup wizard to create, and register an account.
4. Search and add the device to the mobile client.



NOTE

For detailed instructions about adding the camera to the mobile application, please refer to the user manual embedded in the application.

CHAPTER 8 SYSTEM SETTINGS

8.1 Set Macro Mode

In the macro mode, you can focus extremely close on a very small object, and the object appears much larger in the view (and in the final image) compared to the standard lens.

Before You Start

- ◆ Install the macro lens before using this function. Refer to the quick start guide of the macro lens for detailed operation.
- ◆ The macro lens is not included in the package. Please purchase it separately.

1. Go to **Local Settings > Capture Settings > Macro Mode**.
2. Tap  to enable the function.

**NOTE**

- ◆ After the macro mode is enabled, only the emissivity can be modified. Parameters such as distance, image mode, parallax correction, and measurement range cannot be modified.
- ◆ After this function is turned off, the parameters will be restored to the previous set values, and the measurement range will be set to auto switch.

8.2 Set Time and Date

1. Go to **Local Settings > Device Settings > Time and Date**.
2. Set the date and time.
3. Tap  to save and exit.

**NOTE**

Go to **Local Settings > Device Settings > Display Settings** to turn on/off time and date display.

8.3 Set Unit

Go to **Local Settings > Display Settings > Unit** to set the temperature unit and distance unit.

8.4 Set Language

Go to **Local Settings > Device Settings > Language** to select a required language.

8.5 Set Auto-Rotation

Turn on auto-rotation in swipe-down menu.

Or go to **Local Settings > Device Settings > Auto-Rotation** to turn on this function.

CHAPTER 9 MAINTENANCE

9.1 View Device Information

Go to **Local Settings > Device Settings > Device Information** to view the device information.

9.2 Upgrade Device

Before You Start

- ◆ Please download the upgrade file from the official website <http://www.hikmicrotech.com> or contact the custom service and technical support to get the upgrade file first.
 - ◆ Make sure that the device battery is fully charged.
 - ◆ Make sure that Auto Power-off function is turned-off to avoid accidental suspension during upgrading.
1. Connect the device to your PC via the included USB cable, and select **USB Drive** as the USB mode in the prompt on the device.
 2. Unzip the upgrade file and copy it to the root directory of the device.
 3. Disconnect the device from your PC.
 4. Reboot the device and then it will upgrade automatically. The upgrading process will be displayed in the main interface.

**NOTE**

After upgrading, the device reboots automatically. You can view the current version in **Local Settings > Device Settings > Device Information**.

9.3 Restore Device

Go to **Device Settings > Device Initialization > Restore Device** to initialize the device and restore default settings.

9.4 Save Operation logs

The device can collect its operation logs and save in the storage only for troubleshooting. You can turn on/off this function in **Local Settings > Device Settings > Save Logs**.

You can connect the camera to PC using the supplied USB cable, and select USB Drive as the USB mode on camera to export the operation logs (.log) in the root directory of the camera, if necessary.

9.5 Format Storage

Format storage before first use of it.

Tap , and go to **Device Settings** > **Device Initialization**> **Format Storage** to initialize the device memory.

9.6 About Calibration

We recommend you send the device back for calibration once a year, and please contact the local dealer for the information on maintenance points. For more detailed calibration services, please refer to <https://www.hikmicrotech.com/en/support/calibration-service/>.

CHAPTER 10 **FAQ**

10.1 Frequently Asked Questions (FAQ)

Scan the following QR code to get device common FAQ.



LEGAL INFORMATION

© Hangzhou Microimage Software Co., Ltd. All rights reserved.

About this Manual

The Manual includes instructions for using and managing the Product. Pictures, charts, images and all other information hereinafter are for description and explanation only. The information contained in the Manual is subject to change, without notice, due to firmware updates or other reasons. Please find the latest version of this Manual at the HIKMICRO website (<http://www.hikmicrotech.com>).

Please use this Manual with the guidance and assistance of professionals trained in supporting the Product.

Trademarks

 **HIKMICRO** and other HIKMICRO's trademarks and logos are the properties of HIKMICRO in various jurisdictions.

Other trademarks and logos mentioned are the properties of their respective owners.

Disclaimer

TO THE MAXIMUM EXTENT PERMITTED BY APPLICABLE LAW, THIS MANUAL AND THE PRODUCT DESCRIBED, WITH ITS HARDWARE, SOFTWARE AND FIRMWARE, ARE PROVIDED "AS IS" AND "WITH ALL FAULTS AND ERRORS". HIKMICRO MAKES NO WARRANTIES, EXPRESS OR IMPLIED, INCLUDING WITHOUT LIMITATION, MERCHANTABILITY, SATISFACTORY QUALITY, OR FITNESS FOR A PARTICULAR PURPOSE. THE USE OF THE PRODUCT BY YOU IS AT YOUR OWN RISK. IN NO EVENT WILL HIKMICRO BE LIABLE TO YOU FOR ANY SPECIAL, CONSEQUENTIAL, INCIDENTAL, OR INDIRECT DAMAGES, INCLUDING, AMONG OTHERS, DAMAGES FOR LOSS OF BUSINESS PROFITS, BUSINESS INTERRUPTION, OR LOSS OF DATA, CORRUPTION OF SYSTEMS, OR LOSS OF DOCUMENTATION, WHETHER BASED ON BREACH OF CONTRACT, TORT (INCLUDING NEGLIGENCE), PRODUCT LIABILITY, OR OTHERWISE, IN CONNECTION WITH THE USE OF THE PRODUCT, EVEN IF HIKMICRO HAS BEEN ADVISED OF THE POSSIBILITY OF SUCH DAMAGES OR LOSS.

YOU ACKNOWLEDGE THAT THE NATURE OF THE INTERNET PROVIDES FOR INHERENT SECURITY RISKS, AND HIKMICRO SHALL NOT TAKE ANY RESPONSIBILITIES FOR ABNORMAL OPERATION, PRIVACY LEAKAGE OR OTHER DAMAGES RESULTING FROM CYBER-ATTACK, HACKER ATTACK, VIRUS INFECTION, OR OTHER INTERNET SECURITY RISKS; HOWEVER, HIKMICRO WILL PROVIDE TIMELY TECHNICAL SUPPORT IF REQUIRED.

YOU AGREE TO USE THIS PRODUCT IN COMPLIANCE WITH ALL APPLICABLE LAWS, AND YOU ARE SOLELY RESPONSIBLE FOR ENSURING THAT YOUR USE CONFORMS TO THE APPLICABLE LAW. ESPECIALLY, YOU ARE RESPONSIBLE, FOR USING THIS PRODUCT IN A

MANNER THAT DOES NOT INFRINGE ON THE RIGHTS OF THIRD PARTIES, INCLUDING WITHOUT LIMITATION, RIGHTS OF PUBLICITY, INTELLECTUAL PROPERTY RIGHTS, OR DATA PROTECTION AND OTHER PRIVACY RIGHTS. YOU SHALL NOT USE THIS PRODUCT FOR ANY PROHIBITED END-USES, INCLUDING THE DEVELOPMENT OR PRODUCTION OF WEAPONS OF MASS DESTRUCTION, THE DEVELOPMENT OR PRODUCTION OF CHEMICAL OR BIOLOGICAL WEAPONS, ANY ACTIVITIES IN THE CONTEXT RELATED TO ANY NUCLEAR EXPLOSIVE OR UNSAFE NUCLEAR FUEL-CYCLE, OR IN SUPPORT OF HUMAN RIGHTS ABUSES.

IN THE EVENT OF ANY CONFLICTS BETWEEN THIS MANUAL AND THE APPLICABLE LAW, THE LATTER PREVAILS.

REGULATORY INFORMATION

These clauses apply only to the products bearing the corresponding mark or information.

FCC Information

Note: This product has been tested and found to comply with the limits for a Class B digital device, pursuant to Part 15 of the FCC Rules. These limits are designed to provide reasonable protection against harmful interference in a residential installation. This product generates, uses, and can radiate radio frequency energy and, if not installed and used in accordance with the instructions, may cause harmful interference to radio communications. However, there is no guarantee that interference will not occur in a particular installation. If this product does cause harmful interference to radio or television reception, which can be determined by turning the equipment off and on, the user is encouraged to try to correct the interference by one or more of the following measures:

- Reorient or relocate the receiving antenna.
- Increase the separation between the equipment and receiver.
- Connect the equipment into an outlet on a circuit different from that to which the receiver is connected.
- Consult the dealer or an experienced radio/TV technician for help.

Note: Due to the device size limit, the above statement may not be disclaimed on the device.

EU Conformity Statement



This product and - if applicable - the supplied accessories too are marked with "CE" and comply therefore with the applicable harmonized European standards listed under the Directive 2014/30/EU (EMCD), Directive 2014/35/EU (LVD), Directive 2011/65/EU (RoHS).

Hereby, Hangzhou Microimage Software Co., Ltd. declares that this device (refer to the label) is in compliance with Directive 2014/53/EU.

The full text of the EU declaration of conformity is available at the following internet address:

<https://www.hikmicrotech.com/en/support/download-center/declaration-of-conformity/>

Restrictions in the 5 GHz band:

According to Article 10 (10) of Directive 2014/53/EU, when operating in the 5150 to 5350 MHz frequency range, this device is restricted to indoor use in: Austria (AT), Belgium (BE), Bulgaria (BG), Croatia (HR), Cyprus (CY), the Czech Republic (CZ), Denmark (DK), Estonia (EE), Finland (FI), France

(FR), Germany (DE), Greece (EL), Hungary (HU), Iceland (IS), Ireland (IE), Italy (IT), Latvia (LV), Liechtenstein (LI), Lithuania (LT), Luxembourg (LU), Malta (MT), Netherlands (NL), Northern Ireland (UK(NI)), Norway (NO), Poland (PL), Portugal (PT), Romania (RO), Slovakia (SK), Slovenia (SI), Spain (ES), Sweden (SE), Switzerland (CH), and Turkey (TR).

Frequency Bands and Power (for CE)

The frequency bands and modes and transmitting power (radiated and/or conducted) nominal limits applicable to the following radio equipment are as follows:

Wi-Fi: 2.4 GHz (2.4 GHz to 2.4835 GHz): 20 dBm; 5 GHz (5.15 GHz to 5.25 GHz): 23 dBm; 5 GHz (5.25 GHz to 5.35 GHz): 23 dBm; 5 GHz (5.47 GHz to 5.725GHz): 23 dBm; 5 GHz (5.725 GHz to 5.85 GHz): 14 dBm

Bluetooth: 2.4 GHz (2.4 GHz to 2.4835 GHz): 20 dBm

For the device without a supplied power adapter, use the power adapter provided by a qualified manufacturer. Refer to the product specification for detailed power requirements.

For the device without a supplied battery, use the battery provided by a qualified manufacturer. Refer to the product specification for detailed battery requirements.



Directive 2012/19/EU (WEEE Directive): Products marked with this symbol cannot be disposed of as unsorted municipal waste in the European Union. For proper recycling, return this product to your local supplier upon the purchase of equivalent new equipment, or dispose of it at designated collection points. For more information see: www.recyclethis.info



Directive 2006/66/EC and its amendment 2013/56/EU (Battery Directive): This product contains a battery that cannot be disposed of as unsorted municipal waste in the European Union. See the product documentation for specific battery information. The battery is marked with this symbol, which may include lettering to indicate cadmium (Cd), lead (Pb), or mercury (Hg). For proper recycling, return the battery to your supplier or to a designated collection point. For more information see: www.recyclethis.info

Industry Canada ICES-003 Compliance

This device meets the CAN ICES-003 (B)/NMB-003 (B) standards requirements.

This device complies with Industry Canada licence-exempt RSS standard(s). Operation is subject to the following two conditions:

- (1) this device may not cause interference, and
- (2) this device must accept any interference, including interference that may cause

undesired operation of the device.

This equipment complies with IC RSS-102 radiation exposure limits set forth for an uncontrolled environment.

- (i) The device for operation in the band 5150-5250 MHz is only for indoor use to reduce the potential for harmful interference to co-channel mobile satellite systems;
- (ii) The maximum antenna gain permitted for devices in the bands 5250-5350 MHz and 5470-5725 MHz shall comply with the e.i.r.p. limit; and
- (iii) The maximum antenna gain permitted for devices in the band 5725-5825 MHz shall comply with the e.i.r.p. limits specified for point-to-point and non point-to-point operation as appropriate.

Users should also be advised that high-power radars are allocated as primary users (i.e. priority users) of the bands 5250-5350 MHz and 5650-5850 MHz and that these radars could cause interference and/or damage to LE-LAN devices.

Conformité Industrie Canada ICES-003

Le présent appareil est conforme aux CNR d'Industrie Canada applicables aux appareils radioexempts de licence. L'exploitation est autorisée aux deux conditions suivantes:

- (1) l'appareil ne doit pas produire de brouillage, et
- (2) l'utilisateur de l'appareil doit accepter tout brouillage radioélectrique subi, même si le brouillage est susceptible d'en compromettre le fonctionnement.

ce matériel est conforme aux limites de dose d'exposition aux rayonnements, CNR-102 énoncée dans un autre environnement.

- (i) Les dispositifs fonctionnant dans la bande 5150-5250 MHz sont réservés uniquement pour une utilisation à l'intérieur afin de réduire les risques de brouillage préjudiciable aux systèmes de satellites mobiles utilisant les mêmes canaux.
- (ii) Le gain d'antenne maximal autorisé pour les appareils dans les bandes 5250-5350 MHz et 5470-5725 MHz doivent respecter le pire limiter; et
- (iii) Le gain d'antenne maximal autorisé pour les appareils dans la bande 5725-5825 MHz doivent respecter le pire limites spécifiées pour le point-à-point et l'exploitation non point à point, le cas échéant.

Les utilisateurs de radars de haute puissance sont désignés utilisateurs principaux (c.-à-d., qu'ils ont la priorité) pour les bandes 5250-5350 MHz et 5650-5850 MHz et que ces radars pourraient causer du brouillage et/ou des dommages aux dispositifs LAN-EL.

KC

B급 기기: 이 기기는 가정용(B급) 전자파적합기기로서 주로 가정에서 사용하는 것을 목적으로 하며, 모든 지역에서 사용할 수 있습니다.

NCC

取得審驗證明之低功率射頻器材，非經核准，公司、商號或使用者均不得擅自變更頻率、加大功率或變更原設計之特性及功能。

低功率射頻器材之使用不得影響飛航安全及干擾合法通信；經發現有干擾現象時，應立即停用，並改善至無干擾時方得繼續使用。

前述合法通信，指依電信管理法規定作業之無線電通信。

低功率射頻器材須忍受合法通信或工業、科學及醫療用電波輻射性電機設備之干擾。

應避免影響附近雷達系統之操作。

INFORMATIONEN FÜR PRIVATE HAUSHALTE

1. Getrennte Erfassung von Altgeräten:

Elektro- und Elektronikgeräte, die zu Abfall geworden sind, werden als Altgeräte bezeichnet. Besitzer von Altgeräten haben diese einer vom unsortierten Siedlungsabfall getrennten Erfassung zuzuführen. Altgeräte gehören insbesondere nicht in den Hausmüll, sondern in spezielle Sammel- und Rückgabesysteme.

2. Batterien und Akkus sowie Lampen:

Besitzer von Altgeräten haben Altbatterien und Altakkumulatoren, die nicht vom Altgerät umschlossen sind, die zerstörungsfrei aus dem Altgerät entnommen werden können, im Regelfall vor der Abgabe an einer Erfassungsstelle vom Altgerät zu trennen. Dies gilt nicht, soweit Altgeräte einer Vorbereitung zur Wiederverwendung unter Beteiligung eines öffentlich-rechtlichen Entsorgungsträgers zugeführt werden.

3. Möglichkeiten der Rückgabe von Altgeräten:

Besitzer von Altgeräten aus privaten Haushalten können diese bei den Sammelstellen der öffentlich-rechtlichen Entsorgungsträger oder bei den von Herstellern oder Vertreibern im Sinne des ElektroG eingerichteten Rücknahmestellen unentgeltlich abgeben.

Rücknahmepflichtig sind Geschäfte mit einer Verkaufsfläche von mindestens 400 m² für Elektro- und Elektronikgeräte sowie diejenigen Lebensmittelgeschäfte mit einer Gesamtverkaufsfläche von mindestens 800 m², die mehrmals pro Jahr oder dauerhaft Elektro- und Elektronikgeräte anbieten und auf dem Markt bereitstellen. Dies gilt auch bei Vertrieb unter Verwendung von Fernkommunikationsmitteln, wenn die Lager- und Versandflächen für Elektro- und Elektronikgeräte mindestens 400 m² betragen oder die gesamten Lager- und Versandflächen mindestens 800 m² betragen. Vertreter haben die Rücknahme grundsätzlich durch geeignete Rückgabemöglichkeiten in zumutbarer Entfernung zum jeweiligen Endnutzer zu gewährleisten. Die Möglichkeit der unentgeltlichen Rückgabe eines Altgerätes besteht bei rücknahmepflichtigen Vertreibern unter anderem dann, wenn ein neues gleichartiges Gerät, das im Wesentlichen die gleichen Funktionen erfüllt, an einen Endnutzer abgegeben wird.

4. Datenschutz-Hinweis:

Altgeräte enthalten häufig sensible personenbezogene Daten. Dies gilt insbesondere für Geräte der Informations- und Telekommunikationstechnik wie Computer und Smartphones. Bitte beachten Sie in Ihrem eigenen Interesse, dass für die Löschung der Daten auf den zu entsorgenden Altgeräten jeder Endnutzer selbst verantwortlich ist.

5. Bedeutung des Symbols „durchgestrichene Mülltonne“:



Das auf Elektro- und Elektronikgeräten regelmäßig abgebildete Symbol einer durchgestrichenen Mülltonne weist darauf hin, dass das jeweilige Gerät am Ende seiner Lebensdauer getrennt vom unsortierten Siedlungsabfall zu erfassen ist.



See the World in a New Way



HIKMICRO Thermography



support@hikmicrotech.com



HIKMICRO Thermography



hikmicro_thermography



HIKMICRO



<https://www.hikmicrotech.com/>