



HM-ADAPTER-58A

Adapter

The HM-ADAPTER-58A adapter connects the thermal clip-on and the daylight scope. It supports M52 × 0.75 mm thread, used for HIKMICRO THUNDER Clip-On 2.0.

Specification

GENERAL	
DIMENSION	78.5 mm × 99.43 mm × 46.7 mm (3.09" × 3.91" × 1.84")
WEIGHT	90.5 g (0.20 lb)
MOUNTING DIAMETER	58 mm
THREAD	M52 × 0.75 mm
ACCESSORY	Hex Key, Ring

Available Model

HM-ADAPTER-58A

Dimension

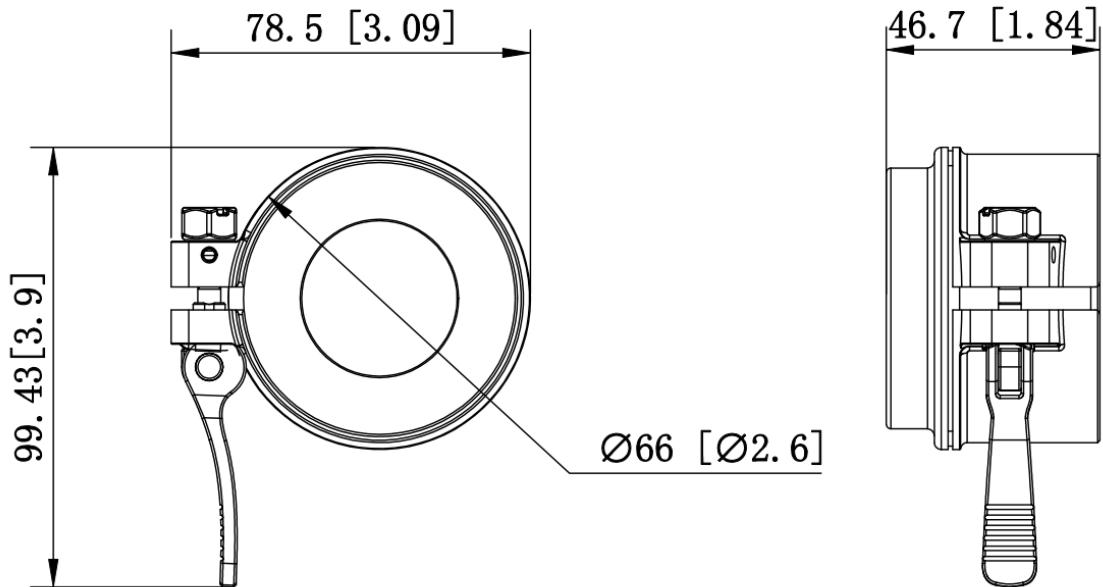

Unit:mm[Inch]



HIKMICRO SIGHT



HIKMICRO Outdoor hikmicro_outdoor HIKMICRO Outdoor HIKMICRO info@hikmicrotech.com <http://hikmicrotech.com/en>

Room 313, Unit B, Building 2, 399 Danfeng Road, Xixing Subdistrict, Binjiang District, Hangzhou, Zhejiang
@hangzhou microimage software co.,Ltd .2020 | data subject to change without notice!