



Thermal Telescope
HIKMICRO FALCON Series

User Manual

Legal Information

©2022 Hangzhou Microimage Software Co., Ltd. All rights reserved.

About this Manual

The Manual includes instructions for using and managing the Product. Pictures, charts, images and all other information hereinafter are for description and explanation only. The information contained in the Manual is subject to change, without notice, due to firmware updates or other reasons. Please find the latest version of this Manual at the HIKMICRO website (www.hikmicrotech.com/).

Please use this Manual with the guidance and assistance of professionals trained in supporting the Product.

Trademarks Acknowledgement

 **HIKMICRO** and other HIKMICRO's trademarks and logos are the properties of

HIKMICRO in various jurisdictions.

Other trademarks and logos mentioned are the properties of their respective owners.

LEGAL DISCLAIMER

TO THE MAXIMUM EXTENT PERMITTED BY APPLICABLE LAW, THIS MANUAL AND THE PRODUCT DESCRIBED, WITH ITS HARDWARE, SOFTWARE AND FIRMWARE, ARE PROVIDED "AS IS" AND "WITH ALL FAULTS AND ERRORS". HIKMICRO MAKES NO WARRANTIES, EXPRESS OR IMPLIED, INCLUDING WITHOUT LIMITATION, MERCHANTABILITY, SATISFACTORY QUALITY, OR FITNESS FOR A PARTICULAR PURPOSE. THE USE OF THE PRODUCT BY YOU IS AT YOUR OWN RISK. IN NO EVENT WILL HIKMICRO BE LIABLE TO YOU FOR ANY SPECIAL, CONSEQUENTIAL, INCIDENTAL, OR INDIRECT DAMAGES, INCLUDING, AMONG OTHERS, DAMAGES FOR LOSS OF BUSINESS PROFITS, BUSINESS INTERRUPTION, OR LOSS OF DATA, CORRUPTION OF SYSTEMS, OR LOSS OF DOCUMENTATION, WHETHER BASED ON BREACH OF CONTRACT, TORT (INCLUDING NEGLIGENCE), PRODUCT LIABILITY, OR OTHERWISE, IN CONNECTION WITH THE USE OF THE PRODUCT, EVEN IF HIKMICRO HAS BEEN ADVISED OF THE POSSIBILITY OF SUCH DAMAGES OR LOSS.

YOU ACKNOWLEDGE THAT THE NATURE OF THE INTERNET PROVIDES FOR INHERENT SECURITY RISKS, AND HIKMICRO SHALL NOT TAKE ANY RESPONSIBILITIES FOR ABNORMAL OPERATION, PRIVACY LEAKAGE OR OTHER DAMAGES RESULTING FROM CYBER-ATTACK, HACKER ATTACK, VIRUS INFECTION, OR OTHER INTERNET SECURITY RISKS; HOWEVER, HIKMICRO WILL PROVIDE TIMELY TECHNICAL SUPPORT IF REQUIRED.

YOU AGREE TO USE THIS PRODUCT IN COMPLIANCE WITH ALL APPLICABLE LAWS, AND YOU ARE SOLELY RESPONSIBLE FOR ENSURING THAT YOUR USE CONFORMS TO THE APPLICABLE LAW. ESPECIALLY, YOU ARE RESPONSIBLE, FOR USING THIS PRODUCT IN A MANNER THAT DOES NOT INFRINGE ON THE RIGHTS OF THIRD PARTIES, INCLUDING WITHOUT LIMITATION, RIGHTS OF PUBLICITY, INTELLECTUAL PROPERTY RIGHTS, OR DATA PROTECTION AND OTHER PRIVACY RIGHTS. YOU SHALL NOT USE THIS PRODUCT FOR ILLEGAL HUNTING ANIMALS, INVASION OF PRIVACY OR ANY OTHER PURPOSE WHICH IS ILLEGAL OR DETRIMENTAL TO THE PUBLIC INTEREST. YOU SHALL NOT USE THIS PRODUCT FOR ANY PROHIBITED END-USES, INCLUDING THE DEVELOPMENT OR PRODUCTION OF WEAPONS OF MASS DESTRUCTION, THE DEVELOPMENT OR PRODUCTION OF

Thermal Image Scope User Manual

CHEMICAL OR BIOLOGICAL WEAPONS, ANY ACTIVITIES IN THE CONTEXT RELATED TO ANY NUCLEAR EXPLOSIVE OR UNSAFE NUCLEAR FUEL-CYCLE, OR IN SUPPORT OF HUMAN RIGHTS ABUSES.

IN THE EVENT OF ANY CONFLICTS BETWEEN THIS MANUAL AND THE APPLICABLE LAW, THE LATTER PREVAILS.

Regulatory Information

FCC Information

Please take attention that changes or modification not expressly approved by the party responsible for compliance could void the user's authority to operate the equipment.

FCC compliance: This equipment has been tested and found to comply with the limits for a Class B digital device, pursuant to part 15 of the FCC Rules. These limits are designed to provide reasonable protection against harmful interference in a residential installation. This equipment generates, uses and can radiate radio frequency energy and, if not installed and used in accordance with the instructions, may cause harmful interference to radio communications. However, there is no guarantee that interference will not occur in a particular installation. If this equipment does cause harmful interference to radio or television reception, which can be determined by turning the equipment off and on, the user is encouraged to try to correct the interference by one or more of the following measures:

- Reorient or relocate the receiving antenna.
- Increase the separation between the equipment and receiver.
- Connect the equipment into an outlet on a circuit different from that to which the receiver is connected.
- Consult the dealer or an experienced radio/TV technician for help

This equipment should be installed and operated with a minimum distance 20cm between the radiator and your body.

FCC Conditions

This device complies with part 15 of the FCC Rules. Operation is subject to the following two conditions:

1. This device may not cause harmful interference.
2. This device must accept any interference received, including interference that may cause undesired operation.

Note: Due to the device size limit, the above statement may not be disclaimed on the device. This equipment complies with FCC radiation exposure limits set forth for an uncontrolled environment.

EU Conformity Statement



This product and - if applicable - the supplied accessories too are marked with "CE" and comply therefore with the applicable harmonized European standards listed under the Directive 2014/30/EU (EMCD), Directive 2014/35/EU (LVD), Directive 2011/65/EU (RoHS).



This product and - if applicable - the supplied accessories too are marked with "UKCA" and comply therefore with the following directives: Radio Equipment Regulations 2017, Electromagnetic Compatibility Regulations 2016, Electrical Equipment (Safety) Regulations 2016, the Restriction of the Use of Certain

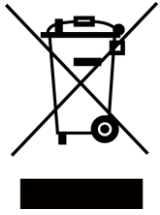

Hazardous Substances in Electrical and Electronic Equipment Regulations 2012.

Directive 2012/19/EU (WEEE Directive): Products marked with this symbol cannot be disposed of as unsorted municipal waste in the European Union. For proper recycling, return this product to your local supplier upon the purchase of equivalent new equipment, or dispose of it at designated collection points.

For more information see: www.recyclethis.info

According to the Waste Electrical and Electronic Equipment Regulations 2013: Products marked with this symbol cannot be disposed of as unsorted municipal waste in the United Kingdom. For proper recycling, return this product to your local supplier upon the purchase of equivalent new equipment, or dispose of it at designated collection points. For more information see: www.recyclethis.info.



Directive 2006/66/EC and its amendment 2013/56/EU (Battery Directive): This product contains a battery that cannot be disposed of as unsorted municipal waste in the European Union. See the product documentation for specific battery information. The battery is marked with this symbol, which may include lettering to indicate cadmium (Cd), lead (Pb), or mercury (Hg). For proper recycling, return the battery to your supplier or to a designated collection point. For more information see: www.recyclethis.info.

According to the Batteries and Accumulators (Placing on the Market) Regulations 2008 and the Waste Batteries and Accumulators Regulations 2009: This product contains a battery that cannot be disposed of as unsorted municipal waste in the United Kingdom. See the product documentation for specific battery information. The battery is marked with this symbol, which may include lettering to indicate cadmium (Cd), lead (Pb), or mercury (Hg). For proper recycling, return the battery to your supplier or to a designated collection point. For more information see: www.recyclethis.info.

Industry Canada ICES-003 Compliance

This device meets the CAN ICES-3 (B)/NMB-3(B) standards requirements.

This device complies with Industry Canada licence-exempt RSS standard(s). Operation is subject to the following two conditions:

- (1) this device may not cause interference, and
- (2) this device must accept any interference, including interference that may cause undesired operation of the device.

Le présent appareil est conforme aux CNR d'Industrie Canada applicables aux appareils radioexempts de licence. L'exploitation est autorisée aux deux conditions suivantes :

- (1) l'appareil ne doit pas produire de brouillage, et
- (2) l'utilisateur de l'appareil doit accepter tout brouillage radioélectrique subi, même si le brouillage est susceptible d'en compromettre le fonctionnement.

This equipment complies with IC RSS-102 radiation exposure limits set forth for an uncontrolled environment.



ce matériel est conforme aux limites de dose d'exposition aux rayonnements, CNR-102 énoncée dans un autre environnement.

KC

B급 기기: 이 기기는 가정용(B급) 전자파적합기기로서 주로 가정에서 사용하는 것을 목적으로 하며, 모든 지역에서 사용할 수 있습니다.

Symbol Conventions

The symbols that may be found in this document are defined as follows.

Symbol	Description
 Danger	Indicates a hazardous situation which, if not avoided, will or could result in death or serious injury.
 Caution	Indicates a potentially hazardous situation which, if not avoided, could result in equipment damage, data loss, performance degradation, or unexpected results.
 Note	Provides additional information to emphasize or supplement important points of the main text.

Safety Instruction

These instructions are intended to ensure that user can use the product correctly to avoid danger or property loss.

Laws and Regulations

- Use of the product must be in strict compliance with the local electrical safety regulations.

Transportation

- Keep the device in original or similar packaging while transporting it.
- Keep all wrappers after unpacking them for future use. In case of any failure occurred, you need to return the device to the factory with the original wrapper. Transportation without the original wrapper may result in damage on the device and the company shall not take any responsibilities.
- DO NOT drop the product or subject it to physical shock. Keep the device away from magnetic interference.

Power Supply

- The input voltage for the device should meet the Limited Power Source (5 VDC, 2 A) according to the IEC61010-1 standard. Please refer to technical specifications for detailed information.
- Use the power adapter provided by qualified manufacturer. Refer to the product specification for detailed power requirements.
- Make sure the plug is properly connected to the power socket.
- DO NOT connect multiple devices to one power adapter, to avoid over-heating or fire hazards caused by overload.

Battery

- Improper use or replacement of the battery may result in explosion hazard. Replace with the same or equivalent type only. The battery type is 18650 with the protection board, and the battery size should be within 19 mm × 70 mm. The rated voltage and capacity are 3.6 VDC/3.35 Ah (12.06 Wh). Dispose of used batteries in conformance with the instructions provided by the battery manufacturer.
- For long-term storage of the battery, make sure it is fully charged every half year to ensure the battery quality. Otherwise, damage may occur.
- Do not charge other battery types with the supplied charger. Confirm there is no flammable material within 2 m of the charger during charging.
- DO NOT place the battery near heating or fire source. Avoid direct sunlight.
- DO NOT swallow the battery to avoid chemical burns.
- DO NOT place the battery in the reach of children.
- The battery cannot be charged with external power source directly.

Maintenance

- If the product does not work properly, please contact your dealer or the nearest service center.

We shall not assume any responsibility for problems caused by unauthorized repair or maintenance.

- Wipe the device gently with a clean cloth and a small quantity of ethanol, if necessary.
- If the equipment is used in a manner not specified by the manufacturer, the protection provided by the device may be impaired.
- It is recommended to reboot the device every 2 hours when using it to ensure the device performance.

Using Environment

- Make sure the running environment meets the requirement of the device. The operating temperature shall be -30°C to 55°C (-22°F to 131°F), and the operating humidity shall be 95% or less.
- DO NOT expose the device to extremely hot, cold, dusty, corrosive, saline-alkali, or damp environments.
- This device can only be safely used in the region below 2000 meters above the sea level.
- Avoid equipment installation on vibratory surface or places subject to shock (neglect may cause equipment damage).
- DO NOT aim the lens at the sun or any other bright light.

Emergency

- If smoke, odor, or noise arises from the device, immediately turn off the power, unplug the power cable, and contact the service center.

Manufacture Address

Room 313, Unit B, Building 2, 399 Danfeng Road, Xixing Subdistrict, Binjiang District, Hangzhou, Zhejiang 310052, China
Hangzhou Microimage Software Co., Ltd.

COMPLIANCE NOTICE: The thermal series products might be subject to export controls in various countries or regions, including without limitation, the United States, European Union, United Kingdom and/or other member countries of the Wassenaar Arrangement. Please consult your professional legal or compliance expert or local government authorities for any necessary export license requirements if you intend to transfer, export, re-export the thermal series products between different countries.

Table of Contents

Chapter 1 Overview	1
1.1 Device Description	1
1.2 Main Function	1
1.3 Appearance	1
Chapter 2 Preparation	3
2.1 Cable Connection	3
2.2 Install Battery	3
2.3 Power On/Off	4
2.4 Menu Description	5
Chapter 3 Image Settings	6
3.1 Adjust Diopter	6
3.2 Adjust Focus	6
3.3 Adjust Brightness	7
3.4 Adjust Contrast	7
3.5 Select Scene	7
3.6 Set Palettes	8
3.7 Correct Defective Pixel	9
3.8 Image Pro	10
3.9 Flat Field Correction	11
3.10 Adjust Digital Zoom	11
3.11 Set OSD	11
3.11.1 Synchronize Time	11
3.12 Set Brand Logo	12
Chapter 4 Burning Prevention	13
Chapter 5 Hot Tracking	14
Chapter 6 Measure Distance	15
Chapter 7 Picture and Video	16
7.1 Capture Picture	16
7.2 Set Audio	16
7.3 Record Video	16

Thermal Telescope User Manual

7.4 Export Files	17
Chapter 8 Client Software Connection	18
Chapter 9 CVBS Output	19
Chapter 10 Language Settings.....	20
Chapter 11 Unit Settings.....	21
Chapter 12 Maintenance	22
12.1 View Device Information	22
12.2 Upgrade Device	22
12.3 Restore Device.....	22
Chapter 13 Frequently Asked Questions	23
13.1 Why is the monitor off?	23
13.2 The image is not clear, how to adjust it?	23
13.3 Capturing or recording fails. What's the problem?	23
13.4 Why the PC cannot identify the device?	23
Chapter 14 Appendix.....	24
14.1 Device Command.....	24
14.2 Device Communication Matrix	24

Chapter 1 Overview

1.1 Device Description

The thermal telescope is equipped with high-sensitivity IR detector, and adopts advanced thermal imaging technology, to get clear view in poor visibility or dark environment.

It helps to view the target and measure the distance. It can view the moving target and meet the outdoor condition. The device can be widely used for searching and rescuing, hunting, etc.

1.2 Main Function

- Distance Measurement: The device can detect the distance between the target and the device.
- Hot Tracking: The device can detect the highest temperature in the scene and mark the spot.
- Client Software Connection: The device can capture snapshots, record videos, and set parameters by HIKMICRO Sight App after being connected to your phone via hotspot.
- Image Correction: The device supports DPC (Defective Pixel Correction) and FFC (Flat Field Correction) which can optimize the image quality.

1.3 Appearance

The appearance of thermal telescopes is shown below. Please take the actual product for reference.

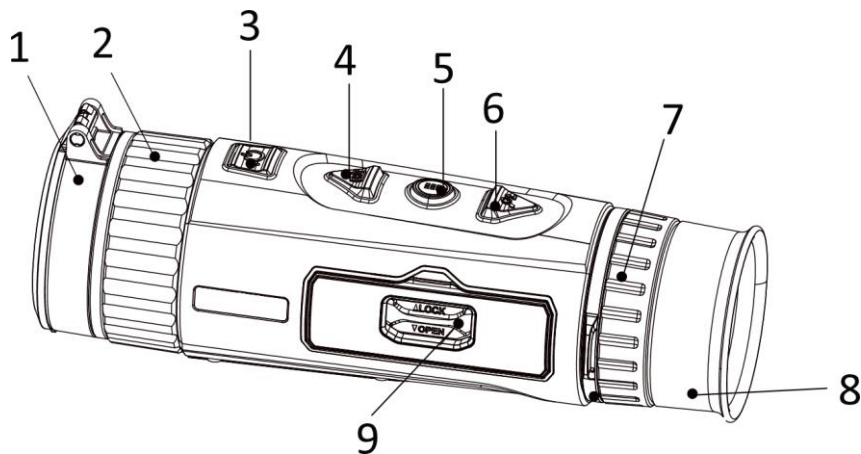

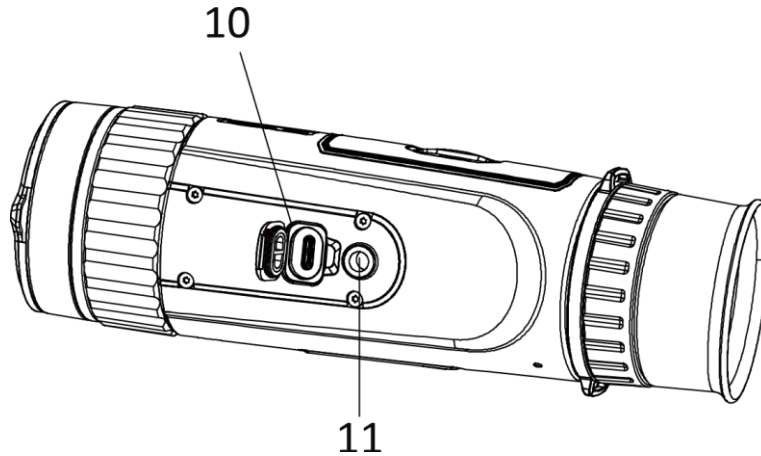

Figure 1-1 Buttons and Interfaces

Table 1-1 Button and Interface Description

No.	Component	Function
1	Lens Cover	Protect the lens.
2	Focus Ring	Adjust the focal length.
3	Power Key	<ul style="list-style-type: none"> ● Press: Standby mode/wake up device ● Hold: Power on/off
4	Capture Key	<ul style="list-style-type: none"> ● Press: capture ● Hold: start/stop recording
5	Menu Key	<ul style="list-style-type: none"> ● Hold: enter/exit menu. ● Press: switch palettes
6	Zoom Key	Press to switch digital zoom.
7	Diopter Adjustment Ring	Adjust the dioptic correction.
8	Eyepiece	View the target.
9	Battery Compartment	Install battery in it.
10	Data Exchange Interface	Charge the device and transmit data.
11	Tripod Mount	Mount the tripod.

Chapter 2 Preparation

2.1 Cable Connection

Connect the device and power adaptor with a type-C cable to power on the device. Alternatively, connect the device and PC to export files.

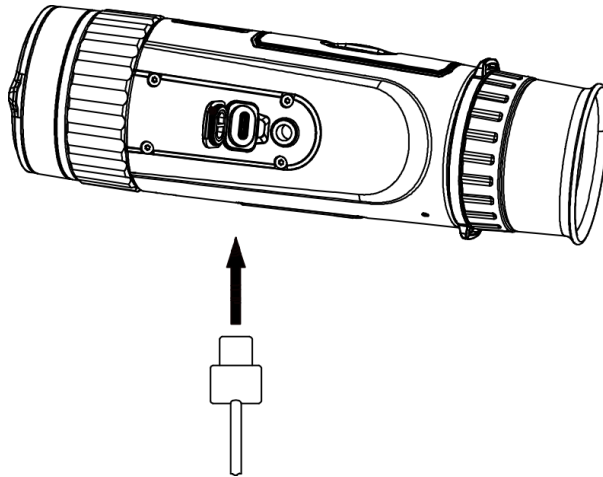

Figure 2-1 Cable Connection

2.2 Install Battery

Insert the battery into the battery compartment.

Steps

1. Unlock the battery compartment cover.

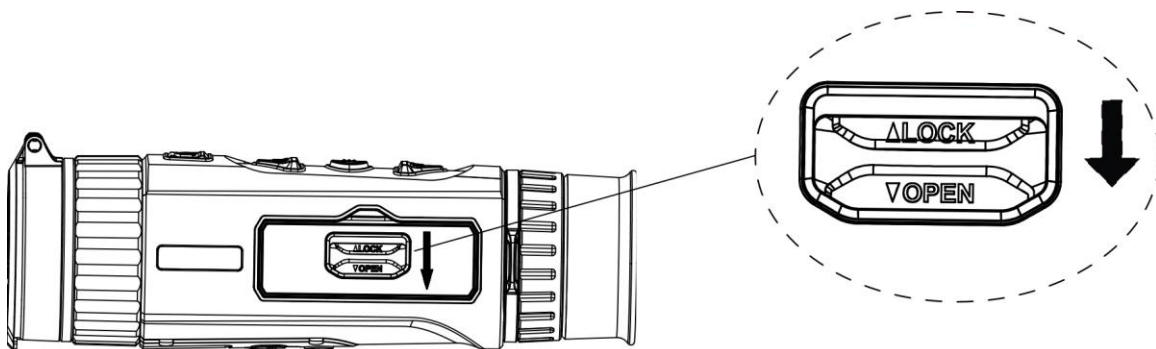

Figure 2-2 Unlock Battery Compartment Cover

2. Open the battery compartment cover.

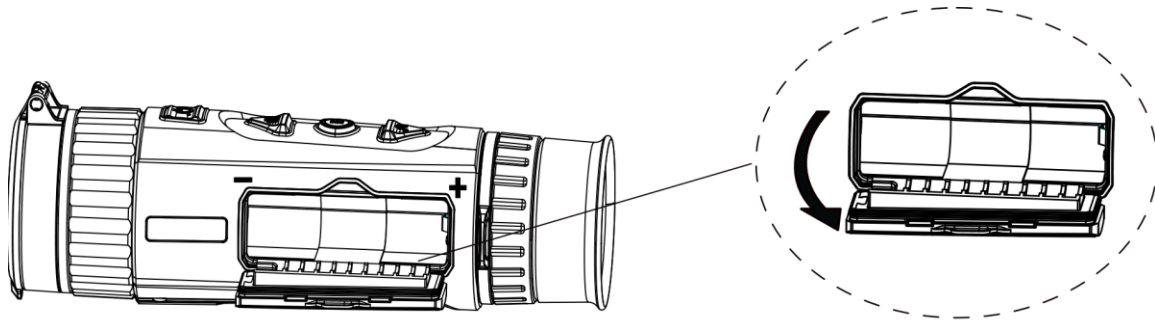

Figure 2-3 Open Battery Compartment Cover

3. Insert the battery into the battery compartment as the positive and negative marks indicate.

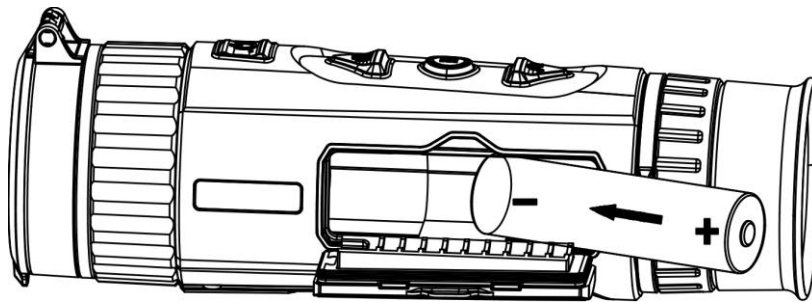

Figure 2-4 Install Battery

4. Close the battery compartment cover and lock it.

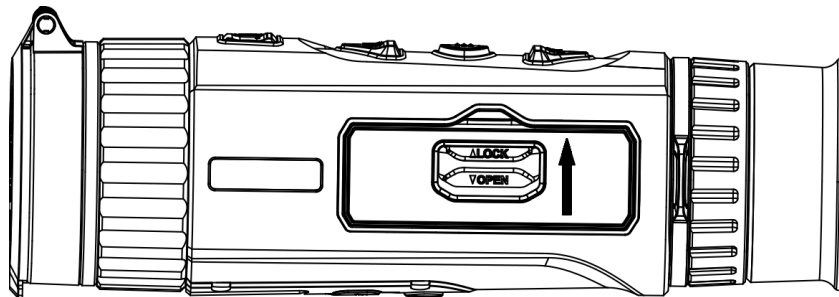

Figure 2-5 Complete Installation

Take the battery away if the device is not used for a long time.

2.3 Power On/Off

Power On

When the battery is sufficiently charged, hold  for about 2 seconds to power on the device.





Power Off

When the device is turned on, hold  for about 2 seconds to power off the device.



Auto Power Off

Set the auto power off time for your device, and then the device will automatically shut down as the set time.

Steps





1. Hold  to go to the menu.
2. Rotate the wheel to select , and press  to select the auto power off time as required.
3. Hold  to save and exit.

Note

- See the battery icon for the battery status.  means the battery is fully charged, and  means that the battery is low.
 - When the low power note shows, charge the battery.
 - The auto power off countdown will start again when the device exits standby mode, or the device is restarted.
-

2.4 Menu Description

When the device is turned on, hold  to show the menu.

In the menu, you can press  and  to select functions, press  to configure the selected function, and hold  to exit the menu.

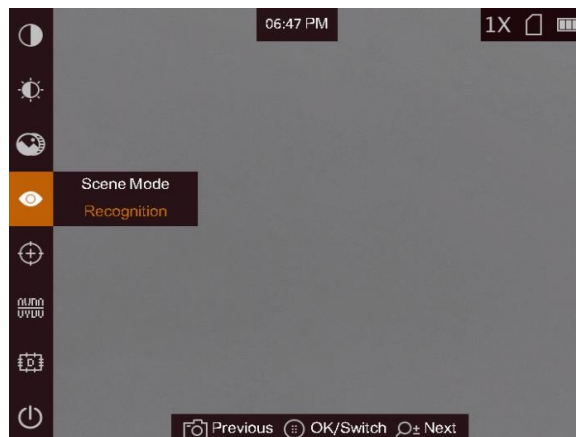

Figure 2-6 Menu Interface

Chapter 3 Image Settings

3.1 Adjust Diopter

Steps

1. Power on the device.
2. Hold the device and make sure the eyepiece covers your eye.
3. Adjust the diopter adjustment ring until the OSD text or image is clear.

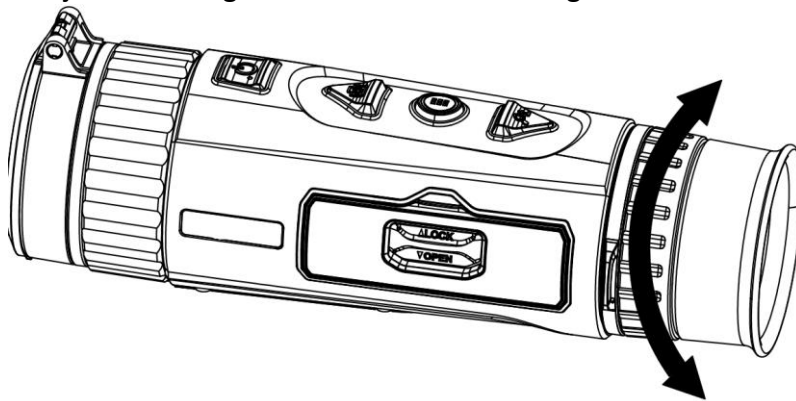

Figure 3-1 Adjust Diopter

Note

When adjusting diopter, DO NOT touch the surface of lens to avoid smearing the lens.

3.2 Adjust Focus

Steps

1. Power on the device.
2. Open the lens cover.
3. Hold the device and make sure the eyepiece covers your eye.
4. Adjust the focus ring until the image is clear.

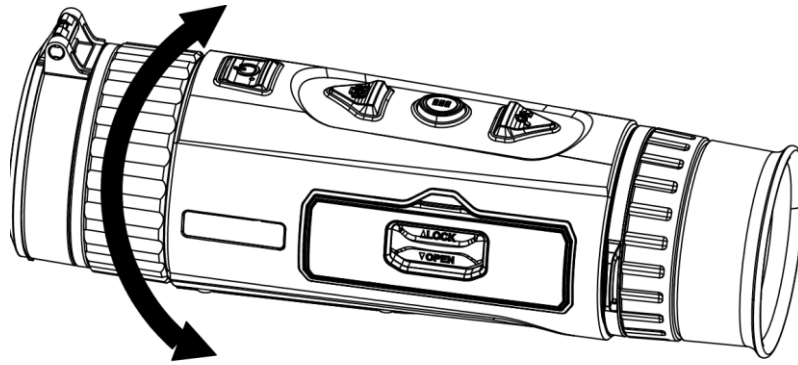

Figure 3-2 Adjust Focus

 **Note**

When adjusting focus, DO NOT touch the surface of lens to avoid smearing the lens.

3.3 Adjust Brightness





In the menu mode, select  and press  to adjust brightness. In white hot mode, the higher the value of brightness is, the brighter the image is. The image effect in white hot mode is showed as picture below and effect in black hot mode is opposite.



Figure 3-3 Adjust Brightness in White Hot Mode



3.4 Adjust Contrast



In the menu mode, select  and press  to adjust image contrast.

3.5 Select Scene

You can select proper scene according to actual using scene to improve the display effect.

Steps

1. Hold  to go to the menu.
2. Select  and press  to switch scene.

-  refers to recognition mode and is recommended in normal scene.
-  refers to jungle mode and is recommended in hunting environment.

3. Hold  to save settings and exit.

3.6 Set Palettes

You can select different palettes to display the same scene in different effects. In the live view interface, press  to switch palettes.

White Hot

The hot part is light-colored in view. The higher the temperature is, the lighter the color is.

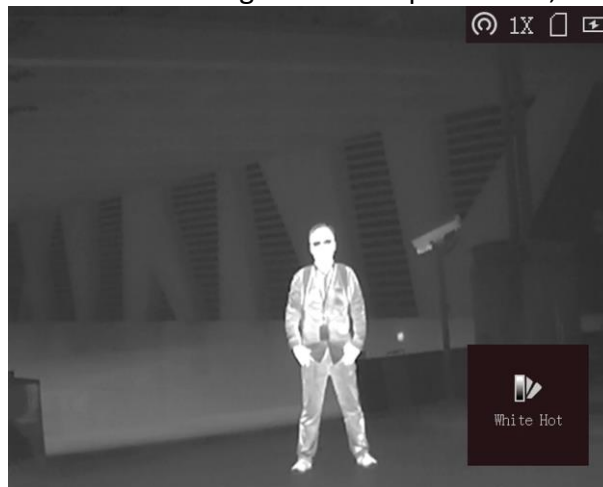

Black Hot

The hot part is black-colored in view. The higher the temperature is, the darker the color is.

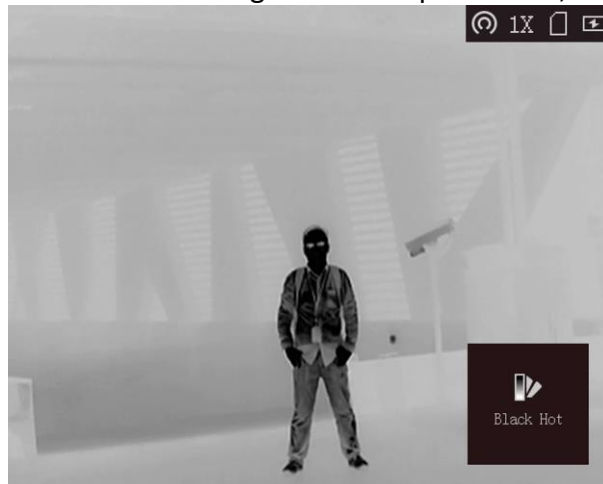

Red Hot

The hot part is red-colored in view. The higher the temperature is, the redder the color is.



Fusion









From high temperature to low temperature, the image is colored in from white, yellow, red, pink to purple.



3.7 Correct Defective Pixel

The device can correct the defective pixels on the screen which are not performed as expected.

Steps

1. Hold  to show the menu.
2. Select .
3. Press  to select the axis direction. If you select **X**, the cursor moves left and right; if you select **Y**, the cursor moves up and down.
4. Press  or  to move the cursor to the defective pixel.
5. Press  to set the axis as **N**, and press  or  to select **DPC**.
6. Press  to correct the defective pixel.

Note

- The selected defective pixel can be magnified and displayed at the bottom right of the interface.

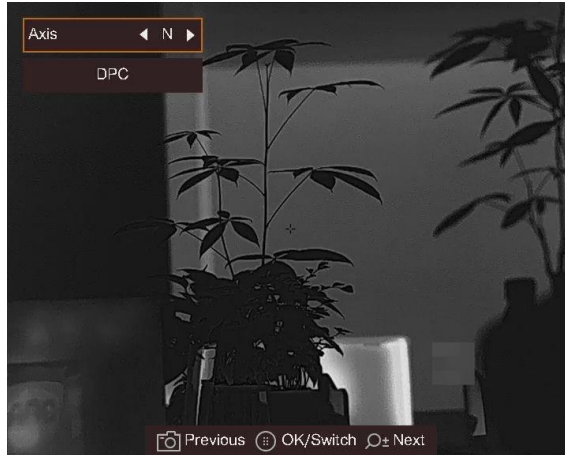

Figure 3-5 Correct Defective Pixel

- If the screen OSD blocks the dead pixel, the device performs mirror display automatically.

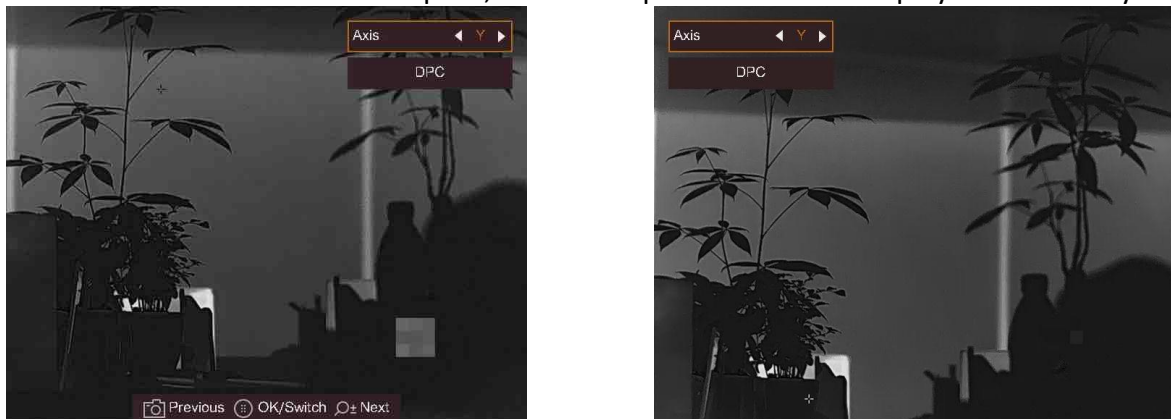





Figure 3-6 Mirror Effect

3.8 Image Pro

Image pro refers to image detail enhancement. When you enable this function, the details of whole live view interface will be enhanced.

Steps

1. Hold  to show the menu.
2. Select .
3. Press  to enable this function.
4. Hold  to return to the live view interface, and view the target.







Result

The details of the whole live view image will be enhanced.

3.9 Flat Field Correction

This function can correct non-uniformity of display.

Steps

1. Hold  to go to the menu.
2. Select  and press  to switch FFC mode.
 - Manual: Hold  in live view to correct the non-uniformity of display.
 - Auto: The device performs FFC automatically according to the set schedule when switching on the camera.
 - External: Cover the lens cover, then hold  in live view to correct the non-uniformity of display.
3. Hold  to save the settings and exit.

3.10 Adjust Digital Zoom

You can zoom the image by using this function.

Press  in the view mode, the live view switches between 1 ×, 2 ×, 4 ×, and 8 ×.

Note











This function varies according to different camera models.

3.11 Set OSD

This function can display or hide the ODS information on the live view interface.

3.11.1 Synchronize Time





Steps

1. Hold  to show the menu.
2. Select  and press  to enter the time setting interface.
3. Press  to switch the time system, and press  and  to select the time and date to be synchronized.
4. Press  to select the hour, minute, second, year, month, or day to be synchronized, and press  and  again to change the number.
5. Hold  to save settings and exit.

3.12 Set Brand Logo

You can add brand logo on the live view interface.

Steps

1. Hold  to show the menu.
2. Select .
3. Press  to enable **Brand Logo**.
4. Hold  to save the settings and exit.

Result

The brand logo is displayed at the bottom right of the image.

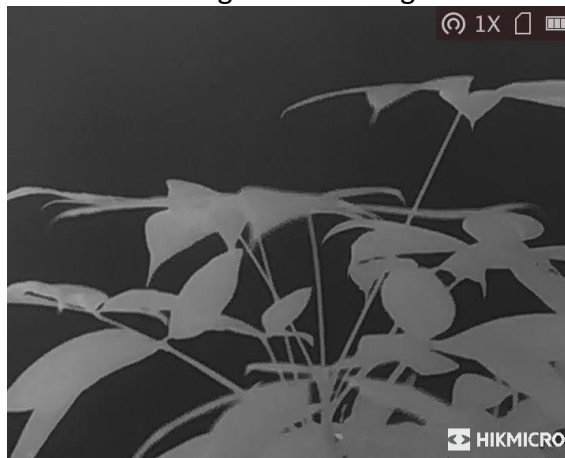

Figure 3-2 Brand Logo Display





Note

After enabling this function, the brand logo only displays on the live view interface, captures and videos.

Chapter 4 Burning Prevention

This function can prevent the detector of the thermal channel from being burned. When you enable this function, the shield will close if the grey scale of the detector reaches a certain value.

Steps

1. Hold  to show the menu.
2. Select  and press  to enable or disable the burn-prevention function.
3. Hold  to save settings and exit.





Note

When the burn-prevention function is disabled, the shield should be opened if it closes.



Chapter 5 Hot Tracking

The device can detect the highest temperature spot in the scene and mark it on display.

Steps

1. Hold  to show the menu.
2. Select  and press  to mark the spot of highest temperature.
3. Hold  to save settings and exit.

Result

When the function is enabled,  displays in the spot of highest temperature. When the scene changes, the  moves.

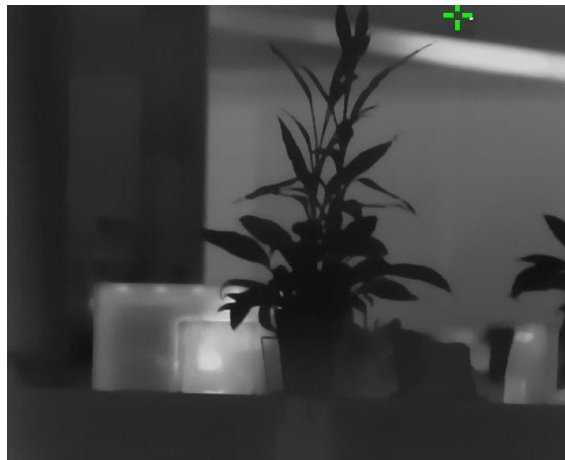

Figure 5-1 Hot Tracking Effect







Chapter 6 Measure Distance

The device can detect the distance between the target and the observation position.

Before You Start



When measuring the distance, keep the hand and the position steady. Otherwise, the accuracy may be affected.

Steps

1. Hold  to show the menu.
2. Select  and press  to go to the setting interface.
 - 1) Press  to select the target from **Deer**, **Grey Wolf**, **Brown Bear**, and **Custom**.
 - 2) Press  to select height, and press  and  to set the target height.

Note

The available height ranges from 0.1 m to 9.9 m.

- 3) Press  to confirm.
3. Align the center of top mark with the edge of target top. Press .
The cursor blinks on the top edge of the target.
4. Align the center of bottom mark with the edge of target bottom. Press .

Result

The left top of the image displays the distance measurement result and the height of the target.



Figure 6-1 Measurement Result

Note

Go to distance measurement interface, and press  to view the result of the previous measuring target.

Chapter 7 Picture and Video

You can manually record video or capture picture when displaying live view.

7.1 Capture Picture

On the main live view page, press  to capture picture.





Note

When capturing succeeds, the image freezes for 1 second and a prompt shows on the display. For exporting captured pictures, refer to ***Export Files***.

7.2 Set Audio

If you enable the audio function, the sound will be recorded with the video. When there is too loud noise in the video, you can disable this function.

Steps

1. Hold  to show the menu.
2. Select .
3. Press  to enable or disable this function.
4. Hold  to save and exit.

7.3 Record Video

Steps



1. In the main live view, hold  and start recording.



Figure 7-1 Start Recording

The left top of image displays the information of recording time.

2. Hold  again to stop recording.

What to do next

For exporting recording files, refer to *Export Files*.

7.4 Export Files

This function is used to export recorded videos and captured pictures.

Before You Start

- Turn off hotspot function.
- Turn on the device after connecting it to your PC, and keep the device on for 10 to 15 seconds before other operations.
- Remove batteries from the device before connecting to your PC, or it may cause device damage.

Steps

1. Connect the device and PC with cable.

Note

Make sure the device is turned on when connecting the cable.

2. Open computer disk and select the disk of device. Go to the **DCIM** folder and find the folder named after the capture year and month. For example, if you capture a picture or record a video on June 2021, go to **DCIM → 202106** to find the picture or video.
3. Select and copy the files to PC.
4. Disconnect the device from your PC.
-



Note

- The device displays images when you connect it to PC. But functions such as recording, capturing and hotspot are disabled.
 - When you connect the device to PC for the first time, it installs the drive program automatically.
-

Chapter 8 Client Software Connection

Connect the device to the HIKMICRO Sight App via hotspot, then you can capture picture, record video, or configure parameters on your phone.

Steps

1. Hold  to show the menu of device.
2. Press  to enable hotspot function.
3. Turn on the WLAN of your phone and connect to the hotspot.
 - Hotspot Name: HIK-IPTS Serial No.
 - Hotspot Password: the last 9 digits of serial No.
4. Search the HIKMICRO Sight App on App Store (iOS System) or Google Play™ (Android System) to download it, or scan the QR code to download and install the app.



Android System



iOS System

5. Open the App and connect your phone with the device. You can view the interface of device on your phone.

Note

- The device cannot connect to the app if entering wrong password several times. Refer to **Restore Device** to reset the device, and connect the app again.
 - The device should be activated for the first use. The default password must be changed after the activation.
-



Chapter 9 CVBS Output

The CVBS output is used to debug the device. You can also view the device image on the display unit for details.

Before You Start

Connect the device to the display unit via CVBS interface of the aviation plug.

Steps

1. Hold  to show the menu.
2. Select , and press  to switch on CVBS.







Note

The CVBS cable is not included in the package. Please purchase it by yourself.

Chapter 10 Language Settings

You can select the device language in this function.





Steps

1. Hold  to show the menu.
2. Select  and press  to enter the language configuration interface.
3. Press  or  to select the language as required, and press  to confirm.

Chapter 11 Unit Settings

You can switch the unit for the distance measurement function.

Steps

1. Hold  to show the menu.
2. Select , and press  to switch the unit. **m** and **yard** are selectable.
3. Hold the  save settings and exit.

Chapter 12 Maintenance

This part introduces the operation of checking device information, upgrading device, and restoring to defaults, etc.

12.1 View Device Information

Steps

1. Hold  to show the menu of device.
2. Select , and press . You can view the device information such as version, and serial No.

12.2 Upgrade Device

Before You Start

- Please get the upgrade package (including Main Firmware and FPGA Firmware) first.
- Make sure the hotspot function is disabled.
- Remove batteries from the device before connecting to your PC.
- Turn on the device after connecting it to your PC, and keep the device on for 10 to 15 seconds before other operations.

Steps

1. Connect the device to your PC with cable, and then turn on the device.
2. Open the detected disk, copy the upgrade file and paste it to the root directory of the device.
3. Hold  to reboot the device, and the device upgrades automatically. The upgrading process will be displayed in the main interface.



Note

During the upgrade, make sure the device is connected to your PC. Otherwise, it may cause unnecessary upgrade failure, firmware damage, etc.

4. Repeat the above steps to upgrade all firmwares one by one.

12.3 Restore Device

Steps

1. Hold  to show the menu of device.
2. Select , and press  to restore the device to defaults according to the prompt.

Chapter 13 Frequently Asked Questions

13.1 Why is the monitor off?

Check whether the device is off-battery. Check the monitor after charging the device for 5 minutes.

13.2 The image is not clear, how to adjust it?

Adjust the diopter adjustment knob until the image is clear. Refer to section Adjust Diopter.

13.3 Capturing or recording fails. What's the problem?

Check the following items.

- Whether the device is connected to your PC. Capturing or recording is disabled in this status.
- Whether the storage space is full.
- Whether the device is low-battery.

13.4 Why the PC cannot identify the device?

Check the following items.

- Whether the device is connected to your PC with supplied USB cable.
- If you use other USB cables, make sure the cable length is no longer than 1 m.
- Whether the hotspot function is turned on. If so, go to device menu and turn off hotspot.

Chapter 14 Appendix

14.1 Device Command

Scan the following QR code to get device common serial port commands.

Note that the command list contains the commonly used serial port commands for HIKMICRO thermal cameras.



14.2 Device Communication Matrix

Scan the following QR code to get device communication matrix.

Note that the matrix contains all communication ports of HIKMICRO thermal cameras.





HIKMICRO

See the World in a New Way



Facebook: HIKMICRO Outdoor Instagram: hikmicro_outdoor

YouTube: HIKMICRO Outdoor

LinkedIn: HIKMICRO