



Thermal Image Scope
PANTHER 2.0 Series

User Manual V5.5.64 202311



Contact Us

CONTENTS

1	Overview.....	1
1.1	Main Function	1
1.2	Appearance.....	1
2	Preparation.....	4
2.1	Install Battery	4
2.1.1	Battery Instruction	4
2.1.2	Battery Installation.....	4
2.2	Cable Connection	5
2.3	Mount Device on Rail.....	6
2.4	Power On/Off	7
2.5	Menu Description.....	7
2.6	App Connection	8
2.7	Firmware Status.....	9
2.7.1	Check Firmware Status	9
2.7.2	Upgrade Device.....	9
2.8	Zeroing	10
3	Image Settings.....	12
3.1	Adjust Diopter	12
3.2	Adjust Focus	12
3.3	Adjust Brightness	13
3.4	Adjust Contrast.....	13
3.5	Adjust Tone.....	13
3.6	Adjust Sharpness.....	14
3.7	Select Scene	14
3.8	Set Palettes.....	14
3.9	Correct Defective Pixel.....	16
3.10	Flat Field Correction	17
3.11	Set Picture in Picture Mode	18
3.12	Adjust Digital Zoom	18
4	Zeroing	20
4.1	Select Zeroing Profile	20
4.2	Set Reticle Style	21

Thermal Image Scope User Manual

4.3	Correct Reticle	21
5	Measure Distance	24
6	Ballistic Calculation for Hunting.....	26
7	General Settings.....	28
7.1	Set OSD	28
7.2	Set Brand Logo	28
7.3	Burning Prevention	29
7.4	Capture and Video	29
7.4.1	Capture Picture	29
7.4.2	Set Audio	29
7.4.3	Record Video.....	30
7.4.4	Prerecord Video	30
7.4.5	Hot Tracking.....	30
7.5	Export Files	31
7.5.1	Export Files via HIKMICRO Sight	31
7.5.2	Export Files via PC	32
8	System Settings.....	34
8.1	Adjust Date.....	34
8.2	Synchronize Time	34
8.3	Set Language	34
8.4	Set Unit	35
8.5	View Device Information	35
8.6	Restore Device	35
9	Frequently Asked Questions.....	36
9.1	Why is the monitor off?	36
9.2	The image is not clear, how to adjust it?.....	36
9.3	Capturing or recording fails. What's the problem?	36
9.4	Why the PC cannot identify the device?	36

1 Overview

HIKMICRO PANTHER 2.0 Thermal Image Scope provides clear image under harsh environment conditions like darkness, fog, smoke, dust, rain, snow, etc. The scope is mainly applied to scenarios such as hunting.

1.1 Main Function

- **Distance Measurement:** Built-in laser range finder provides an accurate distance between the target and the observation position.
- **Zeroing:** The reticle helps you to aim at the target fast and accurately. See *Zeroing*.
- **Audio & Recoil-activated Recording:** The device can record audio and support recoil-activated recording.
- **App Connection:** The device can capture snapshots, record videos, and set parameters by HIKMICRO Sight app after being connected to your phone via hotspot.

1.2 Appearance

There are two types of thermal image scopes. The appearance description of the two types are shown below. Please take the actual product for reference.



Note

Pictures in this manual are for illustration purpose only. Please take the actual product for reference.

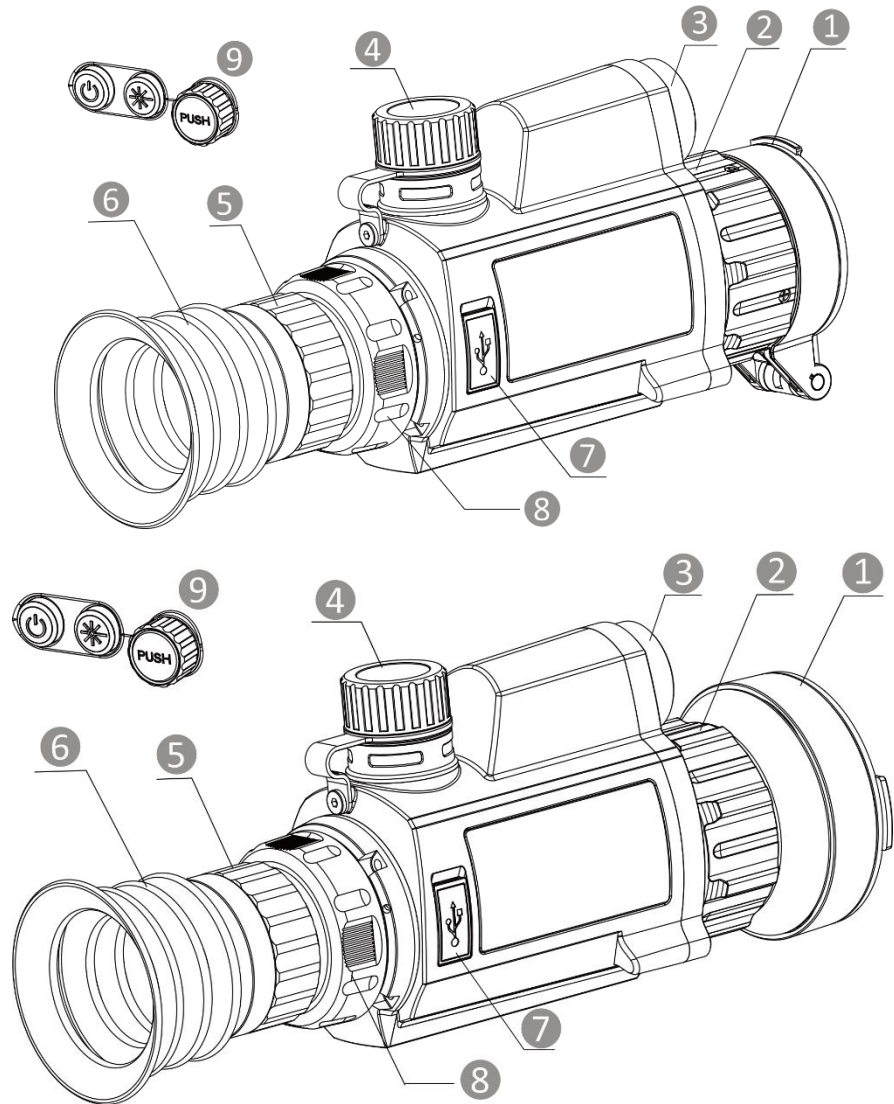

Figure 1-1 Appearance

Table 1-1 Description of Buttons and Components





No.	Component	Description
1	Lens Cover	Protects the lens.
2	Focus Ring	Adjusts focus to obtain clear targets.
3	Laser Range Finder	Measures the distance with laser.
4	Battery Compartment	For holding the battery.
5	Aperture Adjustment Ring	To adjust the size of aperture.

Thermal Image Scope User Manual

No.	Component	Description
6	Eyepiece	The piece placed closest to the eye to view the target.
7	Type-C Interface	To connect the device to power supply or transmit data with a type-C cable.
8	Fixing Ring	To fix the eyepiece.
9	Buttons	To set functions and parameters.

Button Description

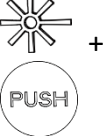
Table 1-2 Button Description

Icon	Button	Function
	Power	<ul style="list-style-type: none"> ● Press: Standby mode/Wake up device. ● Hold: Power on/off.
	Measure	<ul style="list-style-type: none"> ● Press: Turn on/off laser ranging. ● Hold: Start/Stop recording videos.
	Wheel	<p>Non-Menu Mode:</p> <ul style="list-style-type: none"> ● Press: Switch palettes. ● Hold: Enter the menu. ● Rotate: Switch digital zoom. <p>Menu Mode:</p> <ul style="list-style-type: none"> ● Press: Confirm/Set parameters. ● Hold: Save and exit menu. ● Rotate: Move up/move down.
	Measure + Wheel	Press to capture snapshots.
	Power + Measure	Press to correct non-uniformity of display (FFC).

2 Preparation

2.1 Install Battery

2.1.1 Battery Instruction

- The battery type is 18650 with the protection board, and the battery size should be 19 mm × 70 mm. The rated voltage is 3.6 VDC, and the battery capacity is 3200 mAh (11.52 Wh).
- Charge the battery for more than 4 hours before first use.
- Remove the battery if the device is not used for a long time.
- Please purchase the battery recommended by the manufacturer if necessary.

2.1.2 Battery Installation

Insert the batteries into the battery compartment.

Steps

1. Turn the battery cover counterclockwise to loosen it.

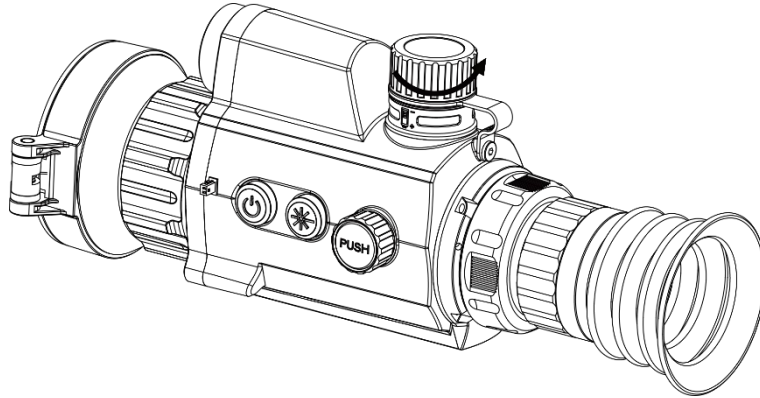

Figure 2-1 Loosen the Cover

2. Insert the battery into the battery compartment with the positive mark inward.

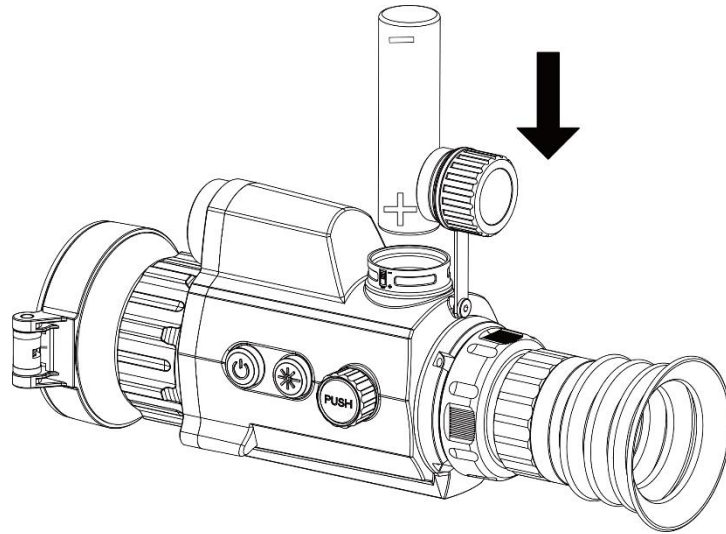

Figure 2-2 Insert the Battery

3. Turn the battery cover clockwise to tighten it.

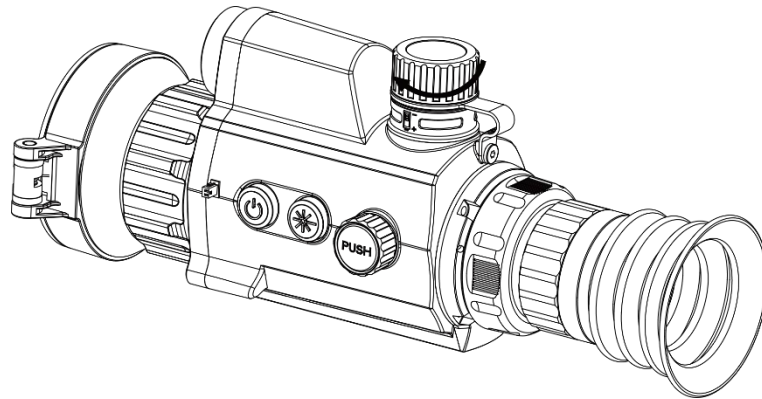

Figure 2-3 Tighten the Cover

2.2 Cable Connection

Connect the device and power adaptor with a type-C cable to power on the device. Alternatively, connect the device and PC to export files.

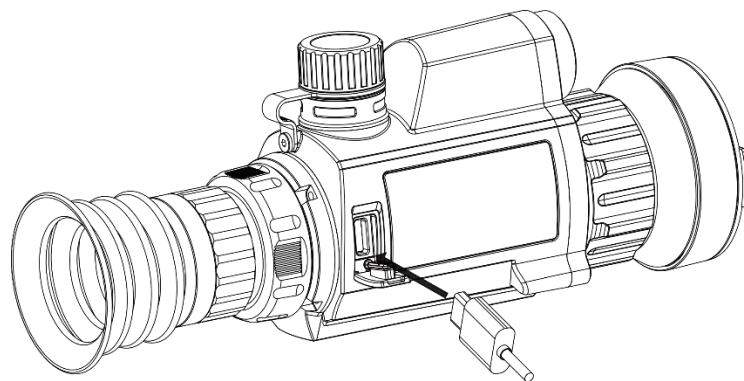

Figure 2-4 Cable Connection

2.3 Mount Device on Rail

Steps

1. Align the screw holes on the device with those on the rail.

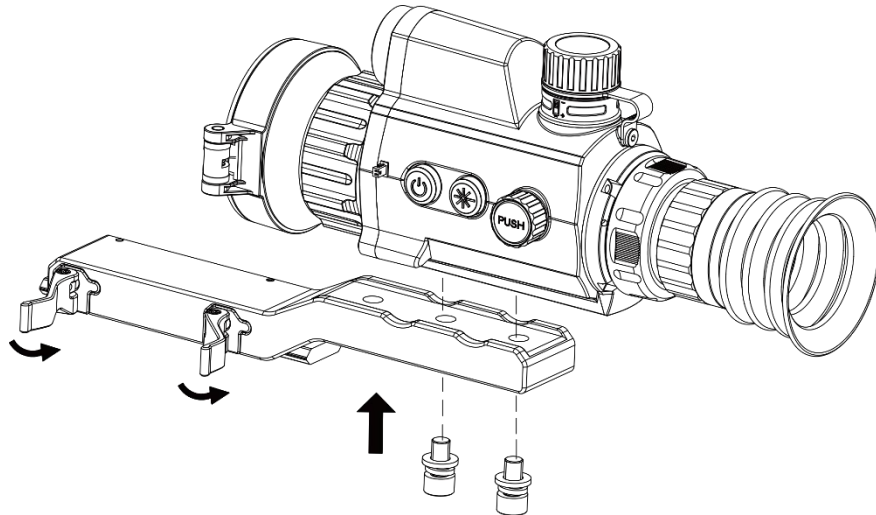

Figure 2-5 Unscrew the Ring Top

2. Insert the screws into the holes and tighten them securely.

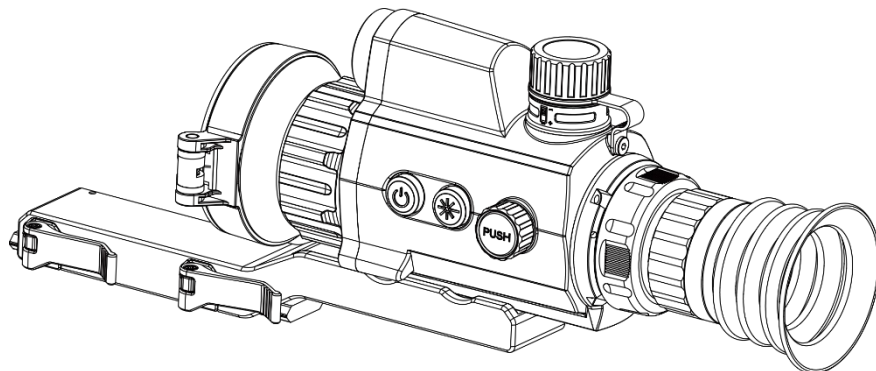

Figure 2-6 Place the Device in the Ring

3. Tighten the levers to secure the device.



Note

The rail is not included in the package. Please purchase separately it as needed.

2.4 Power On/Off

Power On

When the device is connected to cable or the battery is enough, hold  to power on the device.

Power Off

When the device is turned on, hold  to power off the device.





Note

- Power-off countdown will appear when you power off the device. You can press any key to interrupt the countdown and cancel the power-off.
 - Automatic low battery power-off cannot be canceled.
-

Auto Power Off



You can set the auto power off time for your device.

Steps

1. Hold the wheel to show the menu.
 2. Rotate the wheel to select  **General Settings**, and select .
 3. Rotate the wheel to select the auto power off time as required, and press the wheel to confirm.
 4. Hold the wheel to save and exit.
-



Note

- See the battery icon for the battery status.  means the battery is fully charged, and  means that the battery is low.
 - When the low power note shows, charge the battery.
 - The auto power off takes effect only when the device enters the standby mode and the device isn't connected with HIKMICRO Sight app at the same time.
 - The auto power off countdown will start again when the device reenters standby mode, or the device is restarted.
-

2.5 Menu Description

In the live view interface, hold the wheel to show the menu.

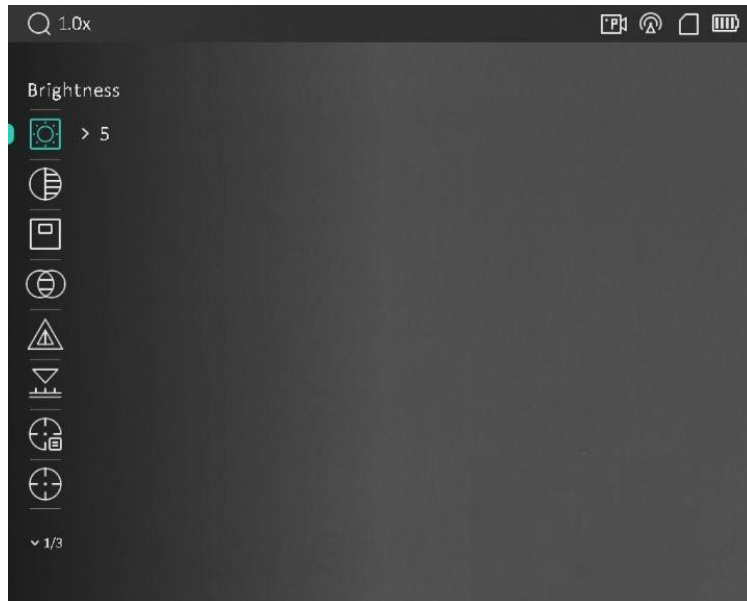

Figure 2-7 Menu Description

2.6 App Connection

Connect the device to the HIKMICRO Sight app via hotspot, then you can capture picture, record video, or configure parameters on your phone.

Steps

1. Search the HIKMICRO Sight on App Store (iOS System) or Google Play™ (Android System) to download it, or scan the QR code to download and install the app.



Android System



iOS System

2. Hold the wheel to show the menu.
3. Rotate the wheel to select  .
4. Press the wheel to enter the setting interface.
5. Rotate the wheel to select **Hotspot**. The hotspot function is enabled.
6. Turn on the WLAN of your phone and connect to the hotspot.
 - Hotspot Name: HIKMICRO_Serial No.

- Hotspot Password: Serial No.

7. Open the app and connect your phone with the device. You can view the interface of device on your phone.



Note

- The device cannot connect to the app if you enter wrong password several times. Refer to **Restore Device** to reset the device, and connect the app again.
 - The device should be activated for the first use. The default password must be changed after the activation.
-

2.7 Firmware Status

2.7.1 Check Firmware Status

Steps

1. Open the HIKMICRO Sight and connect your device to the app.
2. Check if there is an upgrade prompt on the device management interface. If there is no upgrade prompt, the firmware is the latest version. Otherwise, the firmware is not the latest version.

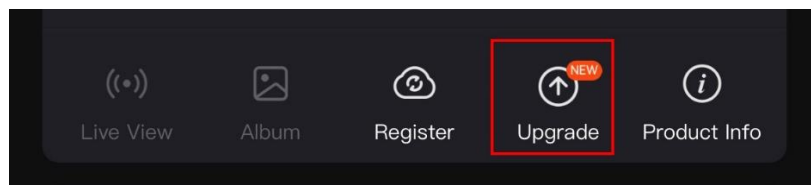

Figure 2-8 Check Firmware Status

3. (Optional) If the firmware is not the latest version, upgrade the device. See **Upgrade Device**.

2.7.2 Upgrade Device

Upgrade Device via HIKMICRO Sight

Before You Start

Install HIKMICRO Sight on your phone and connect your device to the app.

Steps

1. Tap the upgrade prompt to enter the firmware upgrade interface.
2. Tap **Upgrade** to start upgrade.



Note

The upgrading operation may vary due to app updates. Please take the actual app version for reference.

Upgrade Device via PC

Before You Start

Please get the upgrade package first.

Steps

1. Connect the device to your PC with cable.
 2. Open the detected disk, copy the upgrade file and paste it to the root directory of the device.
 3. Disconnect the device from your PC.
 4. Reboot the device, and the device upgrades automatically. The upgrading process will be displayed in the main interface.
-



Caution

During the upgrade package transmission, make sure the device is connected to your PC. Otherwise, it may cause unnecessary upgrade failure, firmware damage, etc.

2.8

Zeroing

You can enable the reticle to view the position of the target. Functions such as freeze and zoom help to adjust the reticle more accurately. See *Zeroing* for detailed instructions.

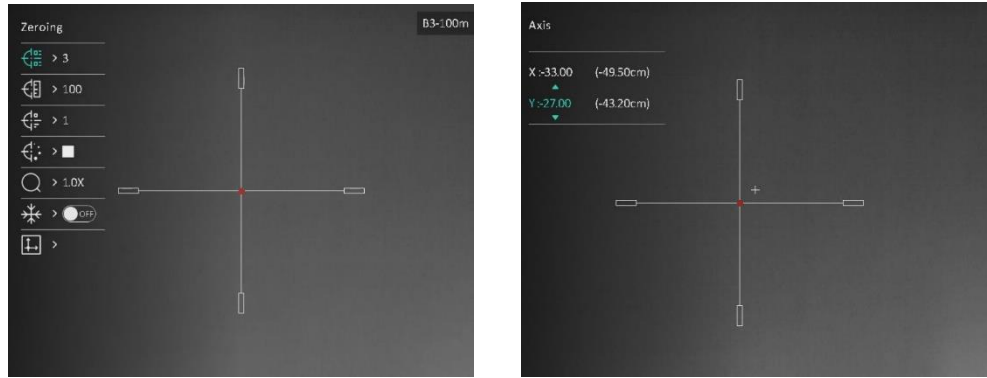

Figure 2-9 Zeroing

3 Image Settings

3.1 Adjust Diopter

Steps

1. Power on the device.
2. Open the lens cover.
3. Hold the device and make sure the eyepiece covers your eye.
4. Adjust the diopter adjustment ring until the OSD information or image is clear.

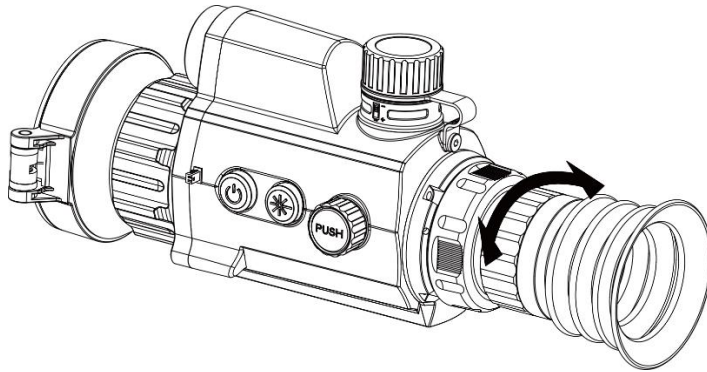

Figure 3-1 Adjust Diopter



Note

When adjusting diopter, DO NOT touch the surface of lens to avoid smearing the lens.

3.2 Adjust Focus

Steps

1. Power on the device.
2. Hold the device and make sure the eyepiece covers your eye.
3. Adjust the focus ring until the image is clear.



Note

When focusing, do not touch the surface of lens to avoid smearing the lens.

3.3 Adjust Brightness

You can adjust the brightness of the screen in the menu.

Steps

1. Hold the wheel to show the menu.
2. Rotate the wheel to select  and press the wheel to confirm.
3. Rotate the wheel to adjust display brightness.
4. Hold the wheel to save settings and exit.

3.4 Adjust Contrast

Steps

1. Hold the wheel to show the menu.
2. Rotate the wheel to select  and press the wheel to confirm.
3. Rotate the wheel to adjust contrast.
4. Hold the wheel to save settings and exit.

3.5 Adjust Tone

Steps

1. In the menu, rotate the wheel to select .
2. Press and rotate the wheel to select a tone. **Warm** and **Cold** are selectable.
3. Hold the wheel to save settings and exit.

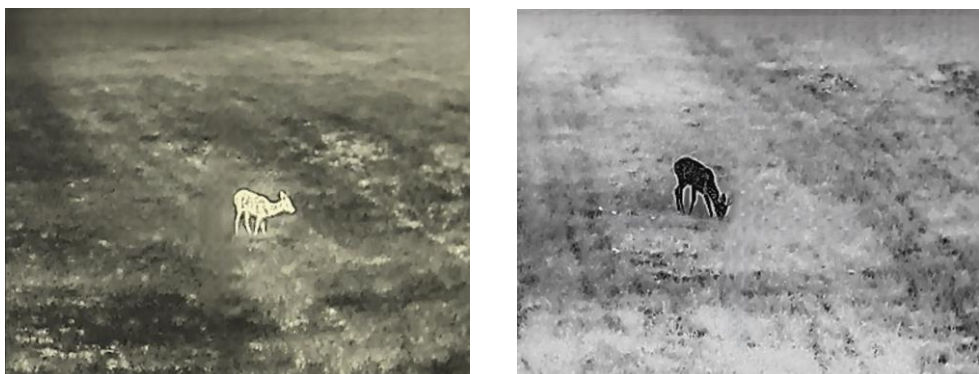

Figure 3-2 Adjust Tone

3.6 Adjust Sharpness

Steps

1. In the menu, rotate the wheel to select .
2. Press and rotate the wheel to adjust sharpness.
3. Hold the wheel to save settings and exit.



Figure 3-3 Sharpness Adjustment Comparison

3.7 Select Scene

You can select proper scene according to actual using scene to improve the display effect.

Steps

1. In the menu, rotate the wheel to select .
2. Press the wheel to enter the setting interface.
3. Press the wheel to switch scene.
 - **Recognition:** Recognition refers to recognition mode and is recommended in normal scene.
 - **Jungle:** Jungle refers to jungle mode and is recommended in hunting environment.
4. Hold the wheel to save settings and exit.

3.8 Set Palettes

You can select different palettes to display the same scene in different effects. Press the wheel in the live view interface to switch palettes.

White Hot

The hot part is light-colored in view. The higher the temperature is, the lighter the color is.



Black Hot

The hot part is black-colored in view. The higher the temperature is, the darker the color is.



Red Hot

The hot part is red-colored in view. The higher the temperature is, the redder the color is.



Fusion





From high temperature to low temperature, the image is colored in from white, yellow, red, pink to purple.



3.9 Correct Defective Pixel

The device can correct the defective pixels on the screen which are not performed as expected.

Steps

1. In the menu, select  **Function Settings**, and press the wheel to enter the sub-menu.
2. Rotate the wheel to select , and press the wheel to enter the DPC setting interface.
3. Rotate the wheel to select  or  axis and press the wheel to confirm. If you select **X-axis**, the cursor moves left and right; if you select **Y-axis**, the cursor moves up and down.

4. Rotate the wheel to move the cursor until it reaches the defective pixel.
5. Select , and press the wheel to correct the dead pixel.



Figure 3-4 Correct Defective Pixel









Note

- The selected defective pixel can be magnified and displayed on the right of the interface.
 - If the screen OSD blocks the defective pixel, move the cursor to reach the defective pixel, then the device performs mirror display automatically.
-

3.10 Flat Field Correction

This function can correct non-uniformity of display.

Steps

1. In the menu, select  **Function Settings** and press the wheel to confirm.
2. Rotate the wheel to select  **Image Calib.**, and press and rotate the wheel to select a FFC mode.
 - Manual FFC: In live view, press  and  to perform FFC.
 - Auto FFC: The device performs FFC automatically.
 - External: Cover the lens cover, then press  and  in live view to perform FFC.
3. Hold the wheel to save and exit.



Note

- You will hear a click and the image will freeze for a second when the device performs FFC.
 - You can also press  and  to perform FFC in auto FFC mode.
-

3.11 Set Picture in Picture Mode

Steps

1. In the menu, rotate the wheel to select .
2. Press the wheel to enable PIP mode. The details show in the upper center.
 - When reticle is enabled, the PIP view is the detail of reticle.
 - When reticle is not enabled, the PIP view is the detail of central part.



Figure 3-5 PIP



Note

If the PIP function is enabled, only the PIP view zooms when adjusting the digital zoom ratio.

3.12 Adjust Digital Zoom

In the live view interface, rotate the wheel to adjust digital zoom of the device.

Steps

1. In the menu, and rotate the wheel to select .
2. Press the wheel to enter the setting interface, and rotate the wheel to select a zoom mode.
 - **Multiple:** The digital zoom ratio can be set to 1×, 2×, 4×, and 8×.
 - **Continuous:** The digital zoom ratio can be set from 1.0× to 8.0× continuously.
3. Hold the wheel to save and exit.
4. In the live view interface, rotate the wheel to switch the digital zoom of the device.

4 Zeroing

4.1 Select Zeroing Profile

You can configure and save the reticle settings in zeroing profiles according to various situation.

Steps

1. In the menu, rotate the wheel to select .
2. Rotate the wheel to select a zeroing profile.
3. Hold the wheel to save and exit.

Result

The right top of the image displays the reticle information. For example, B3-100m means you are using the No. 3 reticle in zeroing profile B, and the set distance is 100 m.

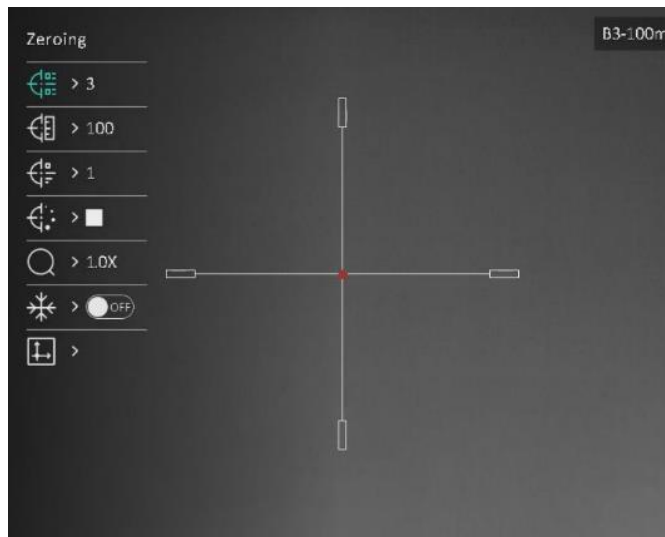

Figure 4-1 Using a Reticle



Note

There are 5 zeroing profiles in total, and you can configure 5 reticles in each zeroing profile.



4.2 Set Reticle Style

You can select a reticle in the current zeroing profile, and set parameters such as type, color, and position for the reticle.

Before You Start

Select a zeroing profile first.

Steps

1. In the menu, rotate the wheel to select . Press the wheel to enter the setting interface.
2. Rotate the wheel to select  or .
3. Press and rotate the wheel to switch types and colors for your reticle.
4. Press again to confirm
5. Hold the wheel to exit according to the prompt.
 - **OK:** Save the parameter and exit.
 - **CANCEL:** Exit and not save the parameters.



Note

- If the PIP function is enabled, the aimed target can be magnified on the interface.
 - In black hot mode and white hot mode, if you set the reticle color as white or black, the color of the reticle will be inverted automatically to better aim at the target.
-

4.3 Correct Reticle





Correcting the reticle can help you aim at the target with high accuracy by marking the offset between the big reticle and small reticle. Functions such as **Freeze** and **Zoom** help to adjust the reticle more accurately.

Before You Start

Select a zeroing profile first.

Steps

1. In the menu, rotate the wheel to select . Press the wheel to enter the setting interface.

2. Select  **Zeroing**, and press the wheel to confirm. Rotate the wheel to select a reticle you want to correct.
3. Set the distance to the target.
 - 1) Rotate the wheel to select  **Distance**.
 - 2) Press the wheel to select the number you want to change.
 - 3) Rotate the wheel to change the number, and press the wheel to finish the setting.
4. Select  **Zoom**, and press the wheel to confirm. Rotate the wheel to set the digital zoom ratio.
5. Aim at the target and pull the trigger.
6. Align the reticle with the point of impact.
 - 1) Aim the big reticle at the target.
 - 2) Select  **Freeze**. Press the wheel to enable the function.
 - 3) Rotate the wheel to set the coordinates until the big reticle aligns with the point of impact. Press the wheel to select **Axis**. If you select **X**, the reticle moves left and right; if you select **Y**, the reticle moves up and down. Hold the wheel to finish setting.

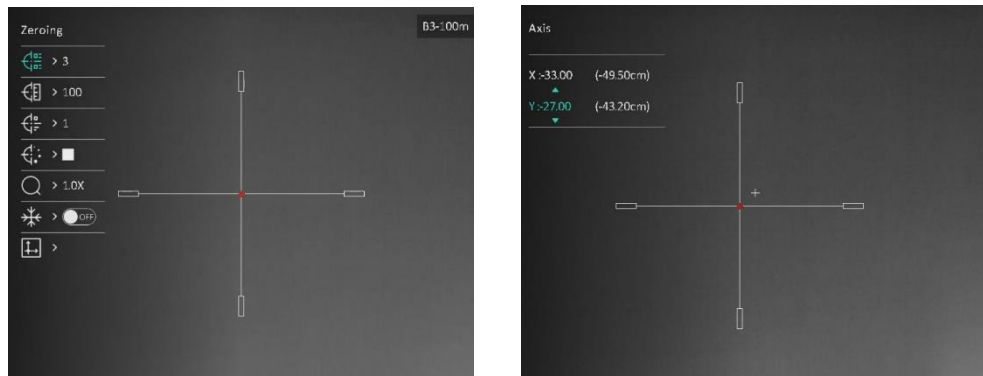

Figure 4-2 Enable Freeze



Note

- When you switch the reticle No., a prompt will appear on the interface. Select **OK** to save the parameters for the current reticle.
- When enabling the freeze function in reticle, you can adjust the position of the cursor on a frozen image. This function can prevent image flutter.

7. Hold the wheel to exit the setting interface according to the prompt.
 - **OK**: Save the parameter and exit.
 - **CANCEL**: Exit but not save the parameters.

8. Pull the trigger again to verify that the aiming point aligns with the point of impact.
9. (Optional) Repeat 2 to 8 to set the position for other reticles in this zeroing profile.

5 Measure Distance

The device can detect the distance between the target and the observation position with laser.

Before You Start

When measuring the distance, keep the hand and the position steady. Otherwise, the accuracy may be affected.

Steps

1. In the menu, rotate the wheel to select . Press the wheel to enter the setting interface.
2. Rotate the wheel to select a laser ranging mode. Press the wheel to confirm.



Note

The device can measure the distance continuously, and the measurement duration can be selected. The measurement result will be refreshed every 1 s.

3. Hold the wheel to save the setting and return to the live view interface.
4. Aim the cursor at the target and press  to measure the target distance.



Note

- Press  in the live view interface to turn on/off the laser ranging,
- Laser ranging cannot be enabled when device battery is low.

Result

The right top of the image displays the distance measurement result.



Figure 5-1 Distance Measurement Result



Caution

The laser radiation emitted from the device can cause eye injuries, burning of skin or inflammable substances. Before enabling the laser ranging function, make sure no human or inflammable substances are in front of the laser lens.



6 Ballistic Calculation for Hunting

The function helps you have a better experience in various conditions. Multiple parameters are used in calculation to ensure precision and flexibility of use.

Before You Start

- Make sure the **Ballistic Calculation** switch is on.
- Make sure the reticle is enabled.
- Make sure you have finished zeroing.

Steps

1. In the menu, rotate the wheel to select . Press the wheel to enter the setting interface.
2. Rotate the wheel to select **Ballistic Profile**, and press the wheel to switch the profile. You can configure and save the settings in respective profiles.
3. Rotate the wheel to select the following parameters, and press the wheel to input the data.
 - Initial Velocity: The velocity varies in different conditions.
 - Zero Range: The range you have zeroed the device at.
 - Ballistic Coefficient: The measure of its ability to overcome air resistance.
 - Sight Height: The distance between the bore and the center of the lens.
 - Altitude: Set this to your normal altitude.
 - Temperature: Set this to your normal temperature.
4. Press the wheel to switch digit, and rotate the wheel to change the number.
5. Hold the wheel to save and exit.
6. Aim the cursor at the target and press  to measure the target distance. The screen will display the recommended aiming point  and the drop distance in the upper right corner of the interface.

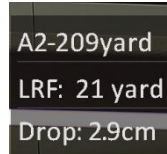

Figure 6-1 Drop Distance

7. (Optional) To adjust the distance, repeat above step.



Note



- 5 ballistic profiles can be saved.
 - The more parameters you specify, the more accurate the recommended aiming point will be.
 - The drop distance is related to the input parameters. Please refer to the actual situation.
-

7 General Settings

7.1 Set OSD

This function can display or hide the OSD information on the live view interface.

Steps

1. In the menu, select  **Function Settings**.
2. Rotate the wheel to select , and press the wheel to enter OSD setting interface.
3. Rotate the wheel to select the **Time, Date, or OSD**, and press the wheel to turn on or turn off the selected OSD information.
4. Hold the wheel to save and exit.





Note

If you turn off **OSD**, all OSD information on the live view will not be displayed.

7.2 Set Brand Logo

You can add brand logo to the live view interface, snapshots, and videos.

Steps

1. In the menu, select  **Function Settings**.
2. Rotate the wheel to select .
3. Press the wheel to enable **Brand Logo**.
4. Hold the wheel to save the settings and exit.



Result

The brand logo is displayed at the bottom left of the image.

7.3 Burning Prevention

This function can prevent the detector of the thermal channel from being burned. When you enable this function, the shield will close if the grey scale of the detector reaches a certain value.

Steps

1. In the menu, select  **Function Settings** and press the wheel to confirm.
2. Rotate the wheel to select , and press the wheel to enable the burn-prevention function.
3. Hold the wheel to save the settings and exit.



Note

Avoid direct sunlight and enable the burning prevention function to reduce the risk of sensor damage from the heat.

7.4 Capture and Video

7.4.1 Capture Picture

In the live view interface, press  and wheel to capture picture.



Note

- When capturing succeeds, the image freezes for 1 second and a prompt shows on the display.
 - For exporting pictures, refer to *Export Files*.
-

7.4.2 Set Audio

If you turn on the audio function, the sound will be recorded with the video. When there is too loud noise in the video, you can turn off this function.

Steps

1. In the menu, and rotate the wheel to select .
2. Press the wheel to enable or disable this function.

3. Hold the wheel to save settings and exit.

7.4.3 Record Video

Steps

1. In the live view interface, hold * to start recording.



Figure 7-1 Start Recording

The upper left image displays the information of recording time.

2. Hold * again to stop recording.

7.4.4 Prerecord Video

After you enable this function and select the prerecording time, the device can automatically start recording the 7 seconds before the recoil-activation and end recording the 7 seconds after the recoil-activation.

Steps

1. In the menu, rotate the wheel to select .
2. Press the wheel to enter the setting interface. Rotate the wheel enable the function.
3. Hold the wheel to save settings and exit.

7.4.5 Hot Tracking

The device can detect the highest temperature spot in the scene and mark it on display.

Steps

1. In the menu, rotate the wheel to select .

2. Press the wheel enable hot tracking.
3. Hold the wheel to save the settings and exit.

Result



When the function is enabled,  displays in the spot of highest temperature. When the scene changes, the  moves.



Figure 7-2 Hot Tracking

7.5 Export Files

7.5.1 Export Files via HIKMICRO Sight

You can access device albums and export files to your phone via HIKMICRO Sight.

Before You Start

Install HIKMICRO Sight on your mobile phone.

Steps

1. Open HIKMICRO Sight and connect your device to the app. See *App Connection*.
2. Tap **Media** to access device albums.

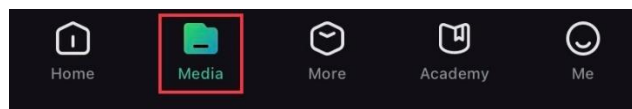

Figure 7-3 Access Device Albums

3. Tap **Local** or **Device** to view the photos and videos.
 - **Local:** You can view the files captured on app.
 - **Device:** You can view the files of the current device.



Note

The photos or videos may not show in **Device**. Please pull down to refresh the page.

4. Tap to select a file, and tap **Download** to export the file to your local phone albums.

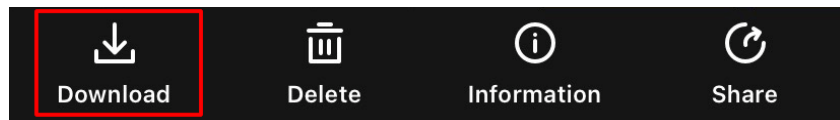

Figure 7-4 Export Files



Note

- Go to **Me** -> **About** -> **User Manual** on the app to see more detailed operations.
 - You can also access device albums by tapping bottom left icon in the live view interface.
 - The exporting operation may vary due to app updates. Please take the actual app version for reference.
-

7.5.2 Export Files via PC

This function is used to export recorded videos and captured pictures.

Before You Start

Make sure the device is turned on when connecting the cable.

Steps

1. Connect the device and PC with cable.
-



Note

Make sure the device is turned on when connecting the cable.

2. Open computer disk and select the disk of device. Go to the DCIM folder and find the folder named after the capture year and month. For example, if you capture a picture or record a video on June 2023, go to **DCIM** -> **202306** to find the picture or video.
3. Select and copy the files to PC.
4. Disconnect the device from your PC.





Note

- The device displays images when you connect it to PC. But functions such as recording, capturing and hotspot are disabled.
 - When you connect the device to PC for the first time, it installs the drive program automatically.
-

8 System Settings



8.1 Adjust Date

Steps

1. In the menu, select  **General Settings**.
2. Rotate the wheel to select , and press the wheel to enter the configuration interface.
3. Press the wheel to select the year, month, or day, and rotate the wheel to change the number.
4. Hold the wheel to save settings and exit.

8.2 Synchronize Time

Step

1. In the menu, select  **General Settings**.
2. Rotate the wheel to select , and press the wheel to enter the configuration interface.
3. Press and rotate the wheel to switch the clock system. 24-hour and 12-hour clock are selectable. If you select 12-hour clock, press the wheel, and then rotate the wheel to select AM or PM.
4. Press the wheel to select the hour or minute, and rotate the wheel to change the number.
5. Hold the wheel to save settings and exit.

8.3 Set Language

You can select the device language in this function.

Steps



1. In the menu, select  **General Settings**.

2. Rotate the wheel to select , and press the wheel to enter the configuration interface.
3. Rotate the wheel to select the language as required, and press the wheel to confirm.
4. Hold the wheel to save settings and exit.

8.4 Set Unit



You can switch the unit for distance measurement.

Steps

1. In the menu, select  **General Settings**.
2. Rotate the wheel to select , and press the wheel to enter the configuration interface.
3. Rotate the wheel to select the unit as required.
4. Hold the wheel to save settings and exit.



8.5 View Device Information

Steps

1. In the menu, select  **General Settings**.
2. Rotate the wheel to select , and press the wheel to confirm. You can view the device information such as version and serial No.
3. Hold the wheel to save settings and exit.

8.6 Restore Device

Steps

1. In the menu, select  **General Settings**.
2. Rotate the wheel to select . Press the wheel to restore the device to defaults according to the prompt.

9 Frequently Asked Questions

9.1 Why is the monitor off?

Check the following items.

- Check whether the device is off-battery.
- Check the monitor after charging the device for 5 minutes.

9.2 The image is not clear, how to adjust it?

Adjust the diopter adjustment ring or focus ring until the image is clear.
Refer to *Adjust Diopter* or *Adjust Focus*.

9.3 Capturing or recording fails. What's the problem?

Check the following items.

- Whether the device is connected to your PC. Capturing or recording is disabled in this status.
- Whether the storage space is full.
- Whether the device is low-battery.

9.4 Why the PC cannot identify the device?

Check the following items.

- Whether the device is connected to your PC with supplied USB cable.
- If you use other USB cables, make sure the cable length is no longer than 1 m.

Legal Information

©2023 Hangzhou Microimage Software Co., Ltd. All rights reserved.

About this Manual

The Manual includes instructions for using and managing the Product. Pictures, charts, images and all other information hereinafter are for description and explanation only. The information contained in the Manual is subject to change, without notice, due to firmware updates or other reasons. Please find the latest version of this Manual at the HIKMICRO website (www.hikmicrotech.com/).

Please use this Manual with the guidance and assistance of professionals trained in supporting the Product.

Trademarks Acknowledgement



and other HIKMICRO's trademarks and logos are the properties of HIKMICRO in various jurisdictions.

Other trademarks and logos mentioned are the properties of their respective owners.

LEGAL DISCLAIMER

TO THE MAXIMUM EXTENT PERMITTED BY APPLICABLE LAW, THIS MANUAL AND THE PRODUCT DESCRIBED, WITH ITS HARDWARE, SOFTWARE AND FIRMWARE, ARE PROVIDED "AS IS" AND "WITH ALL FAULTS AND ERRORS". HIKMICRO MAKES NO WARRANTIES, EXPRESS OR IMPLIED, INCLUDING WITHOUT LIMITATION, MERCHANTABILITY, SATISFACTORY QUALITY, OR FITNESS FOR A PARTICULAR PURPOSE. THE USE OF THE PRODUCT BY YOU IS AT YOUR OWN RISK. IN NO EVENT WILL HIKMICRO BE LIABLE TO YOU FOR ANY SPECIAL, CONSEQUENTIAL, INCIDENTAL, OR INDIRECT DAMAGES, INCLUDING, AMONG OTHERS, DAMAGES FOR LOSS OF BUSINESS PROFITS, BUSINESS INTERRUPTION, OR LOSS OF DATA, CORRUPTION OF SYSTEMS, OR LOSS OF DOCUMENTATION, WHETHER BASED ON BREACH OF CONTRACT, TORT (INCLUDING NEGLIGENCE), PRODUCT LIABILITY, OR OTHERWISE, IN CONNECTION WITH THE USE OF THE PRODUCT, EVEN IF HIKMICRO HAS BEEN ADVISED OF THE POSSIBILITY OF SUCH DAMAGES OR LOSS.

YOU ACKNOWLEDGE THAT THE NATURE OF THE INTERNET PROVIDES FOR INHERENT SECURITY RISKS, AND HIKMICRO SHALL NOT TAKE ANY RESPONSIBILITIES FOR ABNORMAL OPERATION, PRIVACY LEAKAGE OR OTHER DAMAGES RESULTING FROM CYBER-ATTACK, HACKER ATTACK, VIRUS INFECTION, OR OTHER INTERNET SECURITY RISKS; HOWEVER, HIKMICRO WILL PROVIDE TIMELY TECHNICAL SUPPORT IF REQUIRED.

YOU AGREE TO USE THIS PRODUCT IN COMPLIANCE WITH ALL APPLICABLE LAWS, AND YOU ARE SOLELY RESPONSIBLE FOR ENSURING THAT YOUR USE CONFORMS TO THE APPLICABLE LAW. ESPECIALLY, YOU ARE RESPONSIBLE, FOR USING THIS PRODUCT IN A MANNER THAT DOES NOT INFRINGE ON THE RIGHTS OF THIRD PARTIES, INCLUDING WITHOUT LIMITATION, RIGHTS OF PUBLICITY, INTELLECTUAL PROPERTY RIGHTS, OR DATA PROTECTION AND OTHER PRIVACY RIGHTS. YOU SHALL NOT USE THIS PRODUCT FOR ILLEGAL HUNTING ANIMALS, INVASION OF PRIVACY OR ANY OTHER PURPOSE WHICH IS ILLEGAL OR DETRIMENTAL TO THE PUBLIC INTEREST. YOU SHALL NOT USE THIS PRODUCT FOR ANY PROHIBITED END-USES, INCLUDING THE DEVELOPMENT OR PRODUCTION OF WEAPONS OF MASS DESTRUCTION, THE DEVELOPMENT OR PRODUCTION OF CHEMICAL OR BIOLOGICAL WEAPONS, ANY ACTIVITIES IN THE CONTEXT RELATED TO ANY NUCLEAR EXPLOSIVE OR UNSAFE NUCLEAR FUEL-CYCLE, OR IN SUPPORT OF HUMAN RIGHTS ABUSES.

PLEASE FOLLOW ALL THE PROHIBITIONS AND EXCEPTIONAL CAVEATS OF ALL APPLICABLE LAWS AND REGULATIONS, IN PARTICULAR, THE LOCAL FIREARMS AND/OR HUNTING LAWS AND REGULATIONS. PLEASE ALWAYS CHECK NATIONAL PROVISIONS AND REGULATIONS BEFORE PURCHASE OR USE OF THIS PRODUCT. PLEASE NOTE THAT YOU MAY HAVE TO APPLY FOR PERMITS, CERTIFICATES, AND/OR LICENSES BEFORE ANY PURCHASING, SELLING, MARKETING AND/OR USING OF THE PRODUCT. HIKMICRO SHALL NOT BE LIABLE FOR ANY SUCH ILLEGAL OR IMPROPER PURCHASING, SELLING, MARKETING, AND END USES AND ANY SPECIAL, CONSEQUENTIAL, INCIDENTAL, OR INDIRECT DAMAGES ARISING THEREOF.

IN THE EVENT OF ANY CONFLICTS BETWEEN THIS MANUAL AND THE APPLICABLE LAW, THE LATTER PREVAILS.

Regulatory Information

These clauses apply only to the products bearing the corresponding mark or information.

EU Conformity Statement



This product and - if applicable - the supplied accessories too are marked with "CE" and comply therefore with the applicable harmonized European standards listed under the Directive 2014/30/EU (EMCD), Directive 2014/35/EU (LVD), Directive 2011/65/EU (RoHS), Directive 2014/53/EU.

Hereby, Hangzhou Microimage Software Co., Ltd. declares that this device (refer to the label) is in compliance with Directive 2014/53/EU.

The full text of the EU declaration of conformity is available at the following internet address:

<https://www.hikmicrotech.com/en/support/download-center/declaration-of-conformity/>

Frequency Bands and Power (for CE)

The frequency bands and transmitting power (radiated and/or conducted) nominal limits applicable to the following radio equipment are as follows:

Wi-Fi 2.4 GHz (2.4 GHz to 2.4835 GHz), 20 dBm

For the device without a supplied power adapter, use the power adapter provided by a qualified manufacturer. Refer to the product specification for detailed power requirements.

For the device without a supplied battery, use the battery provided by a qualified manufacturer. Refer to the product specification for detailed battery requirements.

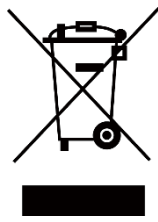

Directive 2012/19/EU (WEEE Directive): Products marked with this symbol cannot be disposed of as unsorted municipal waste in the European Union. For proper recycling, return this product to your local supplier upon the purchase of equivalent new equipment, or dispose of it at designated collection points. For more information see: www.recyclethis.info



Directive 2006/66/EC and its amendment 2013/56/EU (Battery Directive): This product contains a battery that cannot be disposed of as unsorted municipal waste in the European Union. See the product documentation for specific battery information. The battery is marked with this symbol, which may include lettering to indicate cadmium (Cd), lead (Pb), or mercury (Hg). For proper recycling, return the battery to your supplier or to a designated collection point. For more information see: www.recyclethis.info.

INFORMATIONEN FÜR PRIVATE HAUSHALTE

1. Getrennte Erfassung von Altgeräten:

Elektro- und Elektronikgeräte, die zu Abfall geworden sind, werden als Altgeräte bezeichnet. Besitzer von Altgeräten haben diese einer vom unsortierten Siedlungsabfall getrennten Erfassung zuzuführen. Altgeräte gehören insbesondere nicht in den Hausmüll, sondern in spezielle Sammel- und Rückgabesysteme.

2. Batterien und Akkus sowie Lampen:

Besitzer von Altgeräten haben Altbatterien und Altakkumulatoren, die nicht vom Altgerät umschlossen sind, die zerstörungsfrei aus dem Altgerät entnommen werden können, im Regelfall vor der Abgabe an einer Erfassungsstelle vom Altgerät zu trennen. Dies gilt nicht, soweit Altgeräte einer Vorbereitung zur Wiederverwendung unter Beteiligung eines öffentlich-rechtlichen Entsorgungsträgers zugeführt werden.

3. Möglichkeiten der Rückgabe von Altgeräten:

Besitzer von Altgeräten aus privaten Haushalten können diese bei den Sammelstellen der öffentlich-rechtlichen Entsorgungsträger oder bei den von Herstellern oder Vertriebern im Sinne des ElektroG eingerichteten Rücknahmestellen unentgeltlich abgeben. Rücknahmepflichtig sind Geschäfte mit einer Verkaufsfläche von mindestens 400 m² für Elektro- und Elektronikgeräte sowie diejenigen Lebensmittelgeschäfte mit einer Gesamtverkaufsfläche von mindestens 800 m², die mehrmals pro Jahr oder dauerhaft Elektro- und Elektronikgeräte anbieten und auf dem Markt

bereitstellen. Dies gilt auch bei Vertrieb unter Verwendung von Fernkommunikationsmitteln, wenn die Lager- und Versandflächen für Elektro- und Elektronikgeräte mindestens 400 m² betragen oder die gesamten Lager- und Versandflächen mindestens 800 m² betragen. Vertrieber haben die Rücknahme grundsätzlich durch geeignete Rückgabemöglichkeiten in zumutbarer Entfernung zum jeweiligen Endnutzer zu gewährleisten. Die Möglichkeit der unentgeltlichen Rückgabe eines Altgerätes besteht bei rücknahmepflichtigen Vertriebern unter anderem dann, wenn ein neues gleichartiges Gerät, das im Wesentlichen die gleichen Funktionen erfüllt, an einen Endnutzer abgegeben wird.

4. Datenschutz-Hinweis:

Altgeräte enthalten häufig sensible personenbezogene Daten. Dies gilt insbesondere für Geräte der Informations- und Telekommunikationstechnik wie Computer und Smartphones. Bitte beachten Sie in Ihrem eigenen Interesse, dass für die Löschung der Daten auf den zu entsorgenden Altgeräten jeder Endnutzer selbst verantwortlich ist.



5. Bedeutung des Symbols „durchgestrichene Mülltonne“:



Das auf Elektro- und Elektronikgeräten regelmäßig abgebildete Symbol einer durchgestrichenen Mülltonne weist darauf hin, dass das jeweilige Gerät am Ende seiner Lebensdauer getrennt vom unsortierten Siedlungsabfall zu erfassen ist.

Symbol Conventions

The symbols that may be found in this document are defined as follows.

Symbol	Description
 Note	Provides additional information to emphasize or supplement important points of the main text.
 Caution	Indicates a potentially hazardous situation, which if not avoided, could result in equipment damage, data loss, performance degradation, or unexpected results.
 Danger	Indicates a hazard with a high level of risk, which if not avoided, will result in death or serious injury.

Safety Instruction

These instructions are intended to ensure that user can use the product correctly to avoid danger or property loss. Please read all the safety information carefully before using.

Transportation

- Keep the device in original or similar packaging while transporting it.
- Keep all wrappers after unpacking them for future use. In case of any failure occurred, you need to return the device to the factory with the original wrapper. Transportation without the original wrapper may result in damage on the device and the company shall not take any responsibilities.
- Do not drop the product or subject it to physical shock. Keep the device away from magnetic interference.

Power Supply

- The input voltage for the device should meet the Limited Power Source (5 VDC, 2 A) according to the IEC61010-1 standard. Please refer to actual products and technical specifications for detailed information.
- Make sure the plug is properly connected to the power socket.
- DO NOT connect multiple devices to one power adapter, to avoid overheating or fire hazards caused by overload.
- The power source should meet limited power source or PS2 requirements according to IEC 62368-1 standard.

Battery

- The battery type is 18650 with the protection board, and the battery size should be 19 mm × 70 mm. The rated voltage and capacity are 3.6 VDC/3200 mAh (11.52 Wh). Dispose of used batteries in conformance with the instructions provided by the battery manufacturer.
- Make sure the battery temperature is between 0 °C to 45 °C (32 °F to 113 °F) when charging.
- For long-term storage of the battery, make sure it is fully charged every half year to ensure the battery quality. Otherwise, damage may occur.
- Do not charge other battery types with the supplied charger. Confirm there is no flammable material within 2 m of the charger during charging.
- DO NOT place the battery near heating or fire source. Avoid direct

sunlight.

- DO NOT swallow the battery to avoid chemical burns.
- DO NOT place the battery in the reach of children.
- The battery cannot be charged with external power source directly.
- The device cannot be charged, please use the supplied charger to charge the battery.
- Please purchase the adapter by yourself. The using environment of the adapter should be consistent with that of the device.

Maintenance

- If the product does not work properly, please contact your dealer or the nearest service center. We shall not assume any responsibility for problems caused by unauthorized repair or maintenance.
- Wipe the device gently with a clean cloth and a small quantity of ethanol, if necessary.
- If the equipment is used in a manner not specified by the manufacturer, the protection provided by the device may be impaired.
- Clean the lens with soft and dry cloth or wiping paper to avoid scratching it.

Using Environment

- Make sure the running environment meets the requirement of the device. The operating temperature shall be -30 °C to 55 °C (-22 °F to 131 °F), and the operating humidity shall be from 5% to 95%.
- DO NOT expose the device to high electromagnetic radiation or dusty environments.
- DO NOT aim the lens at the sun or any other bright light.
- Place the device in a dry and well-ventilated environment.
- Avoid equipment installation on vibratory surface or places subject to shock (neglect may cause equipment damage).

Emergency

If smoke, odor, or noise arises from the device, immediately turn off the power, unplug the power cable, and contact the service center.

Laser

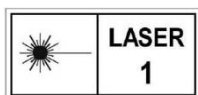

When any laser equipment is in use, make sure that the device lens is not exposed to the laser beam, or it may burn out. The laser radiation emitted from the device can

cause eye injuries, burning of skin or inflammable substances. Before enabling the laser ranging function, make sure no human or inflammable substances are in front of the laser lens. Do not place the device where minors can fetch it. The wavelength is 905 nm, and the max. power output is less than 0.252 mW. According to IEC 60825-1:2014, this laser product is classified as Class 1 laser product.

Manufacture Address

Room 313, Unit B, Building 2, 399 Danfeng Road, Xixing Subdistrict, Binjiang District, Hangzhou, Zhejiang 310052, China

Hangzhou Microimage Software Co., Ltd.

COMPLIANCE NOTICE: The thermal series products might be subject to export controls in various countries or regions, including without limitation, the United States, European Union, United Kingdom and/or other member countries of the Wassenaar Arrangement. Please consult your professional legal or compliance expert or local government authorities for any necessary export license requirements if you intend to transfer, export, re-export the thermal series products between different countries.



HIKMICRO

See the World in a New Way



Facebook: HIKMICRO Outdoor Instagram: hikmicro_outdoor

YouTube: HIKMICRO Outdoor

LinkedIn: HIKMICRO

Web: www.hikmicrotech.com

E-mail: support@hikmicrotech.com

UD32895B-A