

THUNDER TQ35

Thermal Image Scope



Key Features

- 640 × 512 thermal resolution, high sensitivity detector, NETD < 35 mK (25°C, F# = 1.0)
- Image processing technology: Adaptive AGC, DDE, 3D DNR
- 1024 × 768 resolution 0.39-inch OLED display
- Supports distance measurement, and hotspot function
- Supports video recording and snapshot, built-in EMMC (16 GB)
- Supports digital zoom and cursor function, palettes of color adjustable
- Up to 3.25 hours continuous working

Specification

THERMAL MODULE	
Image Sensor	Uncooled Focal Plane Arrays
Max. Resolution	640 × 512
Frame Rate	50 Hz
Pixel Interval	12 μm
Response Waveband	8 μm to 14 μm
NETD	< 35 mK (25°C, F# = 1.0)
Lens (Focal Length)	35 mm
Detection Range	1800 m
IFOV	0.343 mrad
Field of View	12.5° × 10.0°
Min. Focusing Distance	3.5 m
Aperture	F1.0
Magnification	1.8x

IMAGE DISPLAY	
Display	1024 × 768, 0.39 inch, OLED
Palettes	Black hot, white hot, red hot, fusion
Exit Pupil	6 mm
Eye Relief	45 mm
Diopter (Range)	-5 D to 3 D
SYSTEM	
Digital Zoom	1X, 2X, 4X, 8X
Reticle	Yes
Hotspot	Yes
Distance Measurement	Yes
Record Video	On-board video recording
Capture Snapshot	Yes
Hot Track	Yes
Standby Mode	Yes
PIP	Yes
Storage	Built-in EMMC (16 GB)
DPC	Yes
Uniformity Correction	Auto, Manual, External Correction
POWER SUPPLY	
Battery Type	Replaceable Applicable type: CR123A, RCR123A
Battery Operating Time	3.25 h (25°C, with hotspot off)
Battery Capacity Display	Yes
Anti-reverse Battery Connection	Yes
Overvoltage Protection	Yes
Type-C Power Supply	5 VDC, 2 A Supports external power supply
GENERAL	
Work Temperature/Humidity	-20°C to 55°C (-4°F to 131°F)
Protection Level	IP67
Vibration & Shock	750 g/1 ms
Dimension	186.6 mm × 59.4 mm × 67.1 mm
Weight	415 g without eyepiece and batteries

Available Model

HM-TR16-35XG/W-TQ35

Dimension

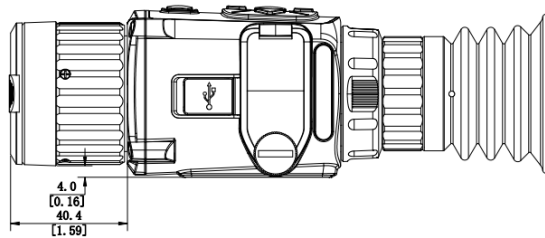
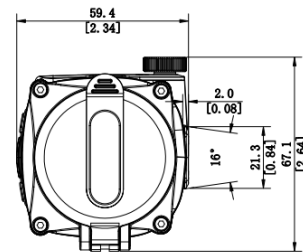
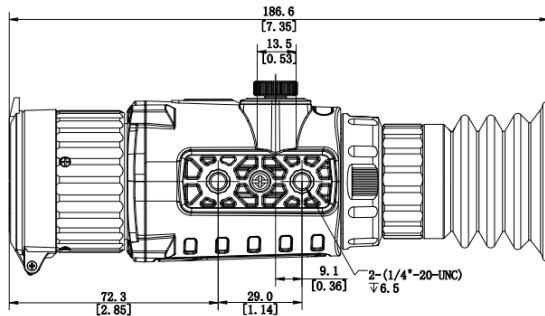

Unit:mm[Inch]

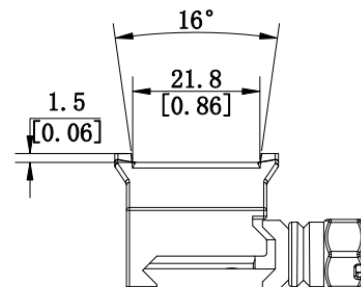
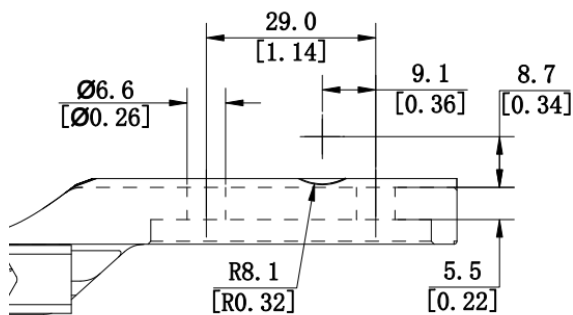

Unit:mm[Inch]

Accessories

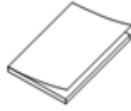

Quick Start Guide
(x1)



Battery CR123A (x2)

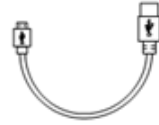

Type-C Cable (x1)

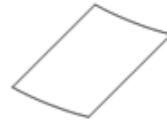

Dust-free Cloth
(x1)



Tightening Plate
(x1)



Bag (x1)

Optional

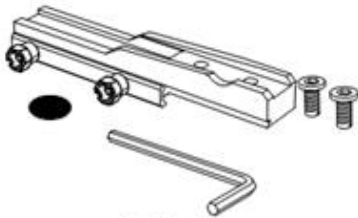

Rail System

Rail (x1)

Tightening Plate (x1)

Screws (x2)

Wrench (x1)

COMPLIANCE NOTICE: The thermal series products might be subject to export controls in various countries or regions, including without limitation, the United States, European Union, United Kingdom and/or other member countries of the Wassenaar Arrangement. Please consult your professional legal or compliance expert or local government authorities for any necessary export license requirements if you intend to transfer, export, re-export the thermal series products between different countries.



 HIKMICRO Outdoor  hikmicro_outdoor  HIKMICRO Outdoor  HIKMICRO  info@hikmicrotech.com  <http://hikmicrotech.com/en>

room 313, unit B, building 2, 399 danfeng road, xixing subdistrict, binjiang district, hangzhou, zhejiang
@hangzhou microimage software co., Ltd .2020 | data subject to change without notice!