

## G41H Handheld Thermal Camera



The HIKMICRO G41 high-performance handheld thermal camera is ideal for industrial, predictive, oil and gas, and utility maintenance inspections. HIKMICRO G41 has a high sensitivity (NETD < 35 mK) and high resolution (480 x 360) HIKMICRO VOx detector, and the temperature calibration is up to 2200°C. Advanced features help thermal imaging professionals to easily survey equipment and find signs of malfunction, such as GPS and compass annotations, continuous digital zoom, and 1-Tap level and span. Connect HIKMICRO Viewer App or HIKMICRO Analyzer software to transfer, analyze, and share pictures, and generate reports for free.

### Key Features

- Thermal resolution: 480 x 360 (172,800 pixels), NETD : < 35 mK (@ 25 °C, F#=1.0)
- Temperature measurement range : -20 °C to 2000 °C (-4 °F to 3632 °F)
- Accuracy: Max ( $\pm 2^{\circ}\text{C}/3.6^{\circ}\text{F}$ ,  $\pm 2\%$ )
- 1.x to 8.x continuous digital zoom
- Manual, automatic, and 1-Tap Level and Span
- GPS & compass annotation functions
- Long-distance laser light supplement for thermography targets
- LED light supplement provides light in dark scenarios

## ▪ Specification

<b>Infrared Image</b>	
IR Resolution	480 x 360 (172,800 pixels)
SuperIR	960 x 720 (691,200 pixels)
NETD	< 35 mK (@ 25 °C, F#=1.0)
Image Frequency	50 Hz
Detector Pitch	17 μm
Spectral Range	7.5 to 14 μm
Focal Length	25 mm
F-number	F 1.0
Field of View (FOV)	18.7° × 14°
Spatial Resolution (IFOV)	0.68 mrad
Min. Focus Distance	0.3 m (0.98 ft)
Focus Mode	Laser Assisted AF/Continuous AF/AF/Manual Focus/Touch AF
Focus Speed	Approx. 2 second
<b>Image Display</b>	
Visual Camera	3264 × 2448 (8 MP)
Display	800 × 480 Resolution, 4.3" LCD Touch Screen
Screen Brightness	Manual/Auto
Digital Zoom	1.x to 8.x continuous
Color Palettes	White Hot, Black Hot, Rainbow, Ironbow, Red Hot, Fusion, Rain, Blue Red
Focus Mode Palette	Above/Below/Interval
Color Alarm	Above/Below/Interval/Insulation/Condensation
Image Modes	Infrared/Visual/Fusion/PIP/Blending
<b>Measurement and Analysis</b>	
Object Temperature Range	-20 °C to 2000 °C (-4 °F to 3632 °F)
Accuracy	Max (±2°C/3.6°F, ±2%)
Measurement Tools	Center Spot, Hot Spot, Cold Spot User-definable: Delta T, 10 spots, 1 line, 5 rectangles, and 5 circle
Level and Span Mode	Auto/Manual/1-Tap Touch-screen
Inspection Route	Yes
<b>Data Storage and Communication</b>	
Storage Media	Removable 64 GB Micro SD Card
Image Storage Capacity	Approx. 60,000 Images
Annotations	Voice note: max. 60 seconds; Text note: max. 200 characters
Video Storage Capacity	Approx. 54 hours
Video File Format	MP4 video and radiometric video
Image Format	Radiometric JPEG
Radiometric Infrared-Video Streaming (Compressed)	Over UVC, Wi-Fi

General	
Wi-Fi	802.11 b/g/n (2.4 GHz and 5 GHz)
Bluetooth	Bluetooth 4.2
USB Interface	USB Type-C
HDMI Interface	Yes
Laser Pointer	Yes
Laser	Yes, Class II, Wavelength: 635 nm; Power: < 1 mW
Laser Distance Meter	Indoor distance: 50 m (164 ft); Outdoor distance: 10 m (33 ft).
GPS & Compass	Yes
Battery Type	Interchangeable and rechargeable Li-ion battery
Battery Operating Time	Approx. 4 hours
Battery Charging Time	Approx. 4 hours fully charged
Power Saving Mode	Yes
Protection Level	IP54, IEC 60529
Drop Test Height	2 m (6.56 ft), IEC 60068-2-31
Safety	IEC 61010-1
EMC	EN 301 489-1, EN 301 489-17, EN IEC 61000-6-2, EN IEC 61000-6-3, EN IEC 61326-1, EN IEC 61326-2-2
Vibration	2 g, IEC 60068-2-6
Shock	25 g, IEC 60068-2-27
Working Temperature Range	-20°C to 50°C ( -4°F to 122°F)
Storage Temperature Range	-20°C to 60°C ( -4°F to 140°F)
Relative Humidity	< 95% non-condensing
Weight	Approx. 1058 g (2.33 lb)
Dimension	284.7 × 120.6 × 124.5 mm (11.21 × 4.75 × 4.9 in)
Tripod Mounting	UNC ¼"-20
LED Light	Yes

## ▪ Available Model

HM-TP74H-25SVF/W-G41H

## ▪ Dimension

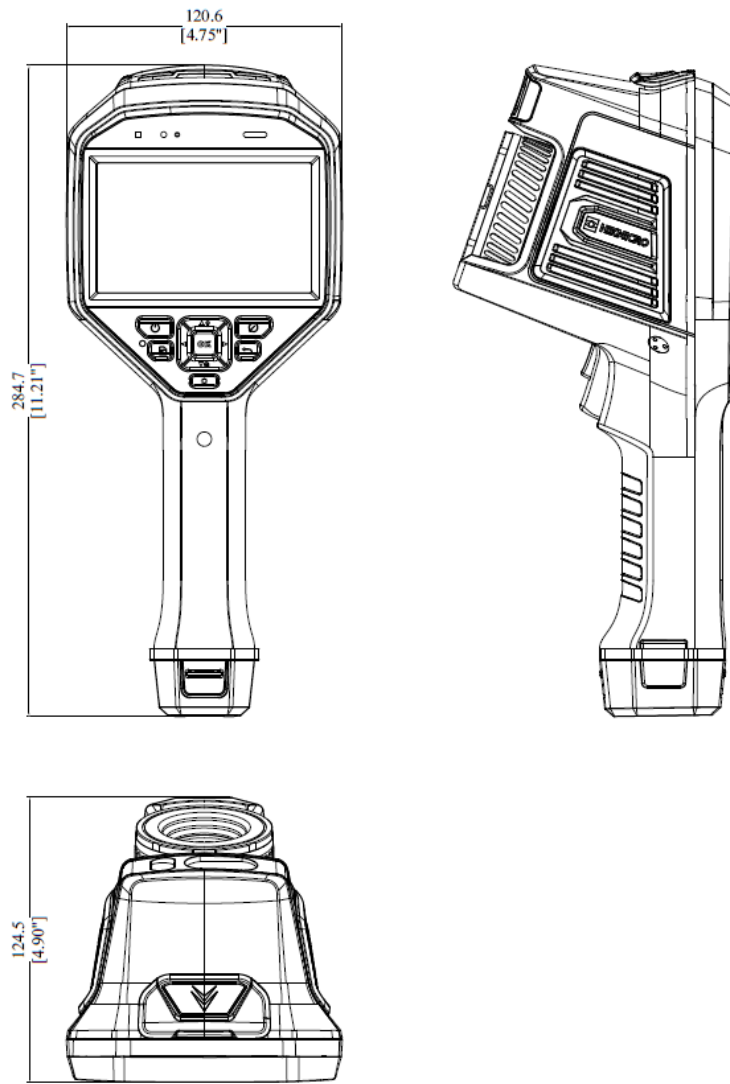

Unit: mm [inch]

## ▪ Optional Accessories



HM-701ZJ-G01-SHIELD  
Handheld Thermography  
Accessory



HM-G605-LENS1  
0.5x wide angle lens, for  
G41 and G61



HM-SP01-POUCH  
M/G/SP Series Pouch



INR18650-35E-1S2P  
G Series Battery



HM-5202ZC2  
G Series Charging Base



HM-G620-LENS1  
2x telephoto lens, for G41  
and G61









HM-G630-LENS1  
3x telephoto lens, for G41  
and G61



COMPLIANCE NOTICE: The thermal series products might be subject to export controls in various countries or regions, including without limitation, the United States, European Union, United Kingdom and/or other member countries of the Wassenaar Arrangement. Please consult your professional legal or compliance expert or local government authorities for any necessary export license requirements if you intend to transfer, export, re-export the thermal series products between different countries.



 HIKMICRO Thermography  hikmicro\_thermography  HIKMICRO Thermography  HIKMICRO  info@hikmicrotech.com  <http://hikmicrotech.com/en>

© 2023 Hangzhou HIKMICRO Sensing Technology Co., Ltd. All Rights Reserved.  
Data subject to change without notice!