



# Handheld Thermography Camera

HIKMICRO M Series User Manual

## Legal Information

© Hangzhou Microimage Software Co., Ltd. All rights reserved.

### About this Manual

The Manual includes instructions for using and managing the Product. Pictures, charts, images and all other information hereinafter are for description and explanation only. The information contained in the Manual is subject to change, without notice, due to firmware updates or other reasons. Please find the latest version of this Manual at the HIKMICRO website (<http://www.hikmicrotech.com>).

Please use this Manual with the guidance and assistance of professionals trained in supporting the Product.

### Trademarks

 **HIKMICRO** and other HIKMICRO's trademarks and logos are the properties of HIKMICRO in various jurisdictions.

Other trademarks and logos mentioned are the properties of their respective owners.

### Disclaimer

TO THE MAXIMUM EXTENT PERMITTED BY APPLICABLE LAW, THIS MANUAL AND THE PRODUCT DESCRIBED, WITH ITS HARDWARE, SOFTWARE AND FIRMWARE, ARE PROVIDED "AS IS" AND "WITH ALL FAULTS AND ERRORS". HIKMICRO MAKES NO WARRANTIES, EXPRESS OR IMPLIED, INCLUDING WITHOUT LIMITATION, MERCHANTABILITY, SATISFACTORY QUALITY, OR FITNESS FOR A PARTICULAR PURPOSE. THE USE OF THE PRODUCT BY YOU IS AT YOUR OWN RISK. IN NO EVENT WILL HIKMICRO BE LIABLE TO YOU FOR ANY SPECIAL, CONSEQUENTIAL, INCIDENTAL, OR INDIRECT DAMAGES, INCLUDING, AMONG OTHERS, DAMAGES FOR LOSS OF BUSINESS PROFITS, BUSINESS INTERRUPTION, OR LOSS OF DATA, CORRUPTION OF SYSTEMS, OR LOSS OF DOCUMENTATION, WHETHER BASED ON BREACH OF CONTRACT, TORT (INCLUDING NEGLIGENCE), PRODUCT LIABILITY, OR OTHERWISE, IN CONNECTION WITH THE USE OF THE PRODUCT, EVEN IF HIKMICRO HAS BEEN ADVISED OF THE POSSIBILITY OF SUCH DAMAGES OR LOSS.

YOU ACKNOWLEDGE THAT THE NATURE OF THE INTERNET PROVIDES FOR INHERENT SECURITY RISKS, AND HIKMICRO SHALL NOT TAKE ANY RESPONSIBILITIES FOR ABNORMAL OPERATION, PRIVACY LEAKAGE OR OTHER DAMAGES RESULTING FROM CYBER-ATTACK, HACKER ATTACK, VIRUS INFECTION, OR OTHER INTERNET SECURITY RISKS; HOWEVER, HIKMICRO WILL PROVIDE TIMELY TECHNICAL SUPPORT IF REQUIRED. YOU AGREE TO USE THIS PRODUCT IN COMPLIANCE WITH ALL APPLICABLE LAWS, AND YOU ARE SOLELY RESPONSIBLE FOR ENSURING THAT YOUR USE CONFORMS TO THE

## Handheld Thermography Camera HIKMICRO M Series User Manual

---

APPLICABLE LAW. ESPECIALLY, YOU ARE RESPONSIBLE, FOR USING THIS PRODUCT IN A MANNER THAT DOES NOT INFRINGE ON THE RIGHTS OF THIRD PARTIES, INCLUDING WITHOUT LIMITATION, RIGHTS OF PUBLICITY, INTELLECTUAL PROPERTY RIGHTS, OR DATA PROTECTION AND OTHER PRIVACY RIGHTS. YOU SHALL NOT USE THIS PRODUCT FOR ANY PROHIBITED END-USES, INCLUDING THE DEVELOPMENT OR PRODUCTION OF WEAPONS OF MASS DESTRUCTION, THE DEVELOPMENT OR PRODUCTION OF CHEMICAL OR BIOLOGICAL WEAPONS, ANY ACTIVITIES IN THE CONTEXT RELATED TO ANY NUCLEAR EXPLOSIVE OR UNSAFE NUCLEAR FUEL-CYCLE, OR IN SUPPORT OF HUMAN RIGHTS ABUSES.

PLEASE FOLLOW ALL THE PROHIBITIONS AND EXCEPTIONAL CAVEATS OF ALL APPLICABLE LAWS AND REGULATIONS, IN PARTICULAR, THE LOCAL FIREARMS AND/OR HUNTING LAWS AND REGULATIONS. PLEASE ALWAYS CHECK NATIONAL PROVISIONS AND REGULATIONS BEFORE PURCHASE OR USE OF THIS PRODUCT. PLEASE NOTE THAT YOU MAY HAVE TO APPLY FOR PERMITS, CERTIFICATES, AND/OR LICENSES BEFORE ANY PURCHASING, SELLING, MARKETING AND/OR USING OF THE PRODUCT. HIKMICRO SHALL NOT BE LIABLE FOR ANY SUCH ILLEGAL OR IMPROPER PURCHASING, SELLING, MARKETING, AND END USES AND ANY SPECIAL, CONSEQUENTIAL, INCIDENTAL, OR INDIRECT DAMAGES ARISING THEREOF.

IN THE EVENT OF ANY CONFLICTS BETWEEN THIS MANUAL AND THE APPLICABLE LAW, THE LATTER PREVAILS.

## Regulatory Information

---

### Note

These clauses apply only to the products bearing the corresponding mark or information.

---

### FCC Compliance Statement

Please take attention that changes or modification not expressly approved by the party responsible for compliance could void the user's authority to operate the equipment. This device complies with Part 15 of the FCC Rules. Operation is subject to the following two conditions:

- (1) This device may not cause harmful interference, and
- (2) This device must accept any interference received, including interference that may cause undesired operation.

Note: Due to the device size limit, the above statement may not be disclaimed on the device. This equipment complies with FCC radiation exposure limits set forth for an uncontrolled environment.

Note: This product has been tested and found to comply with the limits for a Class B digital device, pursuant to Part 15 of the FCC Rules. These limits are designed to provide reasonable protection against harmful interference in a residential installation. This product generates, uses, and can radiate radio frequency energy and, if not installed and used in accordance with the instructions, may cause harmful interference to radio communications. However, there is no guarantee that interference will not occur in a particular installation. If this product does cause harmful interference to radio or television reception, which can be determined by turning the equipment off and on, the user is encouraged to try to correct the interference by one or more of the following measures:

- Reorient or relocate the receiving antenna.
- Increase the separation between the equipment and receiver.
- Connect the equipment into an outlet on a circuit different from that to which the receiver is connected.
- Consult the dealer or an experienced radio/TV technician for help.

### EU Conformity Statement



This product and - if applicable - the supplied accessories too are marked with "CE" and comply therefore with the applicable harmonized European standards listed under the EMC Directive 2014/30/EU, RE Directive 2014/53/EU, the RoHS Directive 2011/65/EU

# Handheld Thermography Camera HIKMICRO M Series User Manual

## Frequency Bands and Power (for CE)

The frequency bands and transmitting power (radiated and/or conducted) nominal limits applicable to the following radio equipment are as follows:

Equipment Model	Frequency Band and Power
M11, M11W, M20, M20W, M30, M60 Series*	Wi-Fi 2.4 GHz (2.4 GHz to 2.4835 GHz): 20 dBm; Bluetooth 2.4 GHz (2.4 GHz to 2.4835 GHz): 20 dBm Wi-Fi 2.4 GHz (2.4 GHz to 2.4835 GHz): 20 dBm; Wi-Fi 5 GHz (5.15 GHz to 5.25 GHz): 23 dBm; Wi-Fi 5 GHz (5.25 GHz to 5.35 GHz): 23 dBm; Wi-Fi 5 GHz (5.47 GHz to 5.725GHz): 23 dBm; Wi-Fi 5 GHz (5.725 GHz to 5.875 GHz): 14 dBm
M10, M11, M11W, M20, M20W, M30, M60 Series	Wi-Fi 2.4 GHz (2.4 GHz to 2.4835 GHz): 20 dBm; Bluetooth 2.4 GHz (2.4 GHz to 2.4835 GHz): 20 dBm

\*For M11, M11W, M20, M20W, M30, M60 Series, please pay attention to the following notes when the device is operating in 5 GHz:

According to Article 10 (10) of Directive 2014/53/EU, when operating in the 5150 to 5350 MHz frequency range, this device is restricted to indoor use in: Austria (AT), Belgium (BE), Bulgaria (BG), Croatia (HR), Cyprus (CY), the Czech Republic (CZ), Denmark (DK), Estonia (EE), Finland (FI), France (FR), Germany (DE), Greece (EL), Hungary (HU), Iceland (IS), Ireland (IE), Italy (IT), Latvia (LV), Liechtenstein (LI), Lithuania (LT), Luxembourg (LU), Malta (MT), Netherlands (NL), Northern Ireland (UK(NI)), Norway (NO), Poland (PL), Portugal (PT), Romania (RO), Slovakia (SK), Slovenia (SI), Spain (ES), Sweden (SE), Switzerland (CH), and Turkey (TR).

5.15-5.35GHzバンドは室内でのみ使用になります。

Use the battery provided by a qualified manufacturer. Refer to the product specification for detailed battery requirements.



2012/19/EU (WEEE directive): Products marked with this symbol cannot be disposed of as unsorted municipal waste in the European Union. For proper recycling, return this product to your local supplier upon the purchase of equivalent new equipment, or dispose of it at designated collection points.

For more information, see: [www.recyclethis.info](http://www.recyclethis.info)

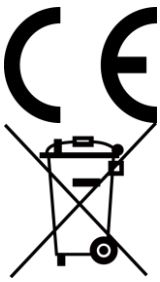

Regulation (EU) 2023/1542 (Battery Regulation): This product contains a battery and it is in conformity with the Regulation (EU) 2023/1542. The battery cannot be disposed of as unsorted municipal waste in the European Union. See the product documentation for specific battery information. The battery is marked with this symbol, which may include lettering to indicate cadmium (Cd), or lead (Pb). For proper recycling, return the battery to your supplier or to a designated collection point. For more information see: [www.recyclethis.info](http://www.recyclethis.info).

## Industry Canada ICES-003 Compliance

This device meets the CAN ICES-003(B)/NMB-003(B) standards requirements.

This device complies with Industry Canada licence-exempt RSS standard(s). Operation is subject to the following two conditions:

- (1) this device may not cause interference, and
- (2) this device must accept any interference, including interference that may cause undesired operation of the device.

This equipment complies with IC RSS-102 radiation exposure limits set forth for an uncontrolled environment.

\*For M11, M11W, M20, M20W, M30, M60 Series, please pay attention to the following notes when the device is operating in 5 GHz:

- (i) The device for operation in the band 5150-5250 MHz is only for indoor use to reduce the potential for harmful interference to co-channel mobile satellite systems;
- (ii) The maximum antenna gain permitted for devices in the bands 5250-5350 MHz and 5470-5725 MHz shall comply with the e.i.r.p. limit; and
- (iii) The maximum antenna gain permitted

Le présent appareil est conforme aux CNR d'Industrie Canada applicables aux appareils radioexempts de licence. L'exploitation est autorisée aux deux conditions suivantes :

- (1) l'appareil ne doit pas produire de brouillage, et
- (2) l'utilisateur de l'appareil doit accepter tout brouillage radioélectrique subi, même si le brouillage est susceptible d'en compromettre le fonctionnement.

ce matériel est conforme aux limites de dose d'exposition aux rayonnements, CNR-102 énoncée dans un autre environnement.

- (i) Les dispositifs fonctionnant dans la bande 5150-5250 MHz sont réservés uniquement pour une utilisation à l'intérieur afin de réduire les risques de brouillage préjudiciable aux systèmes de satellites mobiles utilisant les mêmes canaux.
- (ii) Le gain d'antenne maximal autorisé pour les appareils dans les bandes 5250-5350 MHz et 5470-5725 MHz doivent respecter le pire limiter; et
- (iii) Le gain d'antenne maximal autorisé pour les appareils dans la bande 5725-5875 MHz doivent respecter le pire limites

for devices in the band 5725-5875 MHz shall comply with the e.i.r.p. limits specified for point-to-point and non point-to-point operation as appropriate.

spécifiées pour le point-à-point et l'exploitation non point à point, le cas échéant.

## KC

B급 기기: 이 기기는 가정용(B급) 전자파적합기기로서 주로 가정에서 사용하는 것을 목적으로 하며, 모든 지역에서 사용할 수 있습니다.

## NCC

取得審驗證明之低功率射頻器材，非經核准，公司、商號或使用者均不得擅自變更頻率、加大功率或變更原設計之特性及功能。

低功率射頻器材之使用不得影響飛航安全及干擾合法通信；經發現有干擾現象時，應立即停用，並改善至無干擾時方得繼續使用。

前述合法通信，指依電信管理法規定作業之無線電通信。

低功率射頻器材須忍受合法通信或工業、科學及醫療用電波輻射性電機設備之干擾。應避克影響附近雷達系統之操作。

## INFORMATIONEN FÜR PRIVATE HAUSHALTE

Getrennte Erfassung von Altgeräten:

Elektro- und Elektronikgeräte, die zu Abfall geworden sind, werden als Altgeräte bezeichnet. Besitzer von Altgeräten haben diese einer vom unsortierten Siedlungsabfall getrennten Erfassung zuzuführen. Altgeräte gehören insbesondere nicht in den Hausmüll, sondern in spezielle Sammel- und Rückgabesysteme.

Batterien und Akkus sowie Lampen:

Besitzer von Altgeräten haben Altbatterien und Altakkumulatoren, die nicht vom Altgerät umschlossen sind, die zerstörungsfrei aus dem Altgerät entnommen werden können, im Regelfall vor der Abgabe an einer Erfassungsstelle vom Altgerät zu trennen. Dies gilt nicht, soweit Altgeräte einer Vorbereitung zur Wiederverwendung unter Beteiligung eines öffentlich-rechtlichen Entsorgungsträgers zugeführt werden.

Möglichkeiten der Rückgabe von Altgeräten:

Besitzer von Altgeräten aus privaten Haushalten können diese bei den Sammelstellen der öffentlich-rechtlichen Entsorgungsträger oder bei den von Herstellern oder Vertreibern im Sinne des ElektroG eingerichteten Rücknahmestellen unentgeltlich abgeben.

Rücknahmepflichtig sind Geschäfte mit einer Verkaufsfläche von mindestens 400 m<sup>2</sup> für Elektro- und Elektronikgeräte sowie diejenigen Lebensmittelgeschäfte mit einer Gesamtverkaufsfläche von mindestens 800 m<sup>2</sup>, die mehrmals pro Jahr oder dauerhaft

Elektro- und Elektronikgeräte anbieten und auf dem Markt bereitstellen. Dies gilt auch bei Vertrieb unter Verwendung von Fernkommunikationsmitteln, wenn die Lager- und Versandflächen für Elektro- und Elektronikgeräte mindestens 400 m<sup>2</sup> betragen oder die gesamten Lager- und Versandflächen mindestens 800 m<sup>2</sup> betragen. Vertreiber haben die Rücknahme grundsätzlich durch geeignete Rückgabemöglichkeiten in zumutbarer Entfernung zum jeweiligen Endnutzer zu gewährleisten. Die Möglichkeit der unentgeltlichen Rückgabe eines Altgerätes besteht bei rücknahmepflichtigen Vertreibern unter anderem dann, wenn ein neues gleichartiges Gerät, das im Wesentlichen die gleichen Funktionen erfüllt, an einen Endnutzer abgegeben wird.

### Datenschutz-Hinweis:

Altgeräte enthalten häufig sensible personenbezogene Daten. Dies gilt insbesondere für Geräte der Informations- und Telekommunikationstechnik wie Computer und Smartphones. Bitte beachten Sie in Ihrem eigenen Interesse, dass für die Löschung der Daten auf den zu entsorgenden Altgeräten jeder Endnutzer selbst verantwortlich ist.

Bedeutung des Symbols „durchgestrichene Mülltonne“:





Das auf Elektro- und Elektronikgeräten regelmäßig abgebildete Symbol einer durchgestrichenen Mülltonne weist darauf hin, dass das jeweilige Gerät am Ende seiner Lebensdauer getrennt vom unsortierten Siedlungsabfall zu erfassen ist.



## Symbol Conventions

The symbols that may be found in this document are defined as follows.

Symbol	Description
 <b>Danger</b>	Indicates a hazardous situation which, if not avoided, will or could result in death or serious injury.
 <b>Caution</b>	Indicates a potentially hazardous situation which, if not avoided, could result in equipment damage, data loss, performance degradation, or unexpected results.
 <b>Note</b>	Provides additional information to emphasize or supplement important points of the main text.

## Safety Instruction

These instructions are intended to ensure that user can use the product correctly to avoid danger or property loss.

### Laws and Regulations

- Use of the product must be in strict compliance with the local electrical safety regulations.

### Transportation

- Keep the device in original or similar packaging while transporting it.
- Keep all wrappers after unpacking them for future use. In case of any failure occurred, you need to return the device to the factory with the original wrapper. Transportation without the original wrapper may result in damage on the device and the company shall not take any responsibilities.
- DO NOT drop the product or subject it to physical shock. Keep the device away from magnetic interference.

### Power Supply

- Input voltage for device should meet the Limited Power Source (5 VDC, 2 A) according to the IEC61010-1 standard. Please refer to technical specifications for detailed information.
- Make sure the plug is properly connected to the power socket.
- DO NOT connect multiple devices to one power adapter, to avoid over-heating or fire hazards caused by overload.

### Battery

- This device is not suitable for use in locations where children are likely to be present.
- CAUTION: Risk of explosion if the battery is replaced by an incorrect type. Replace with the same or equivalent type only. Dispose of used batteries in conformance with the instructions provided by the battery manufacturer.
- Improper replacement of the battery with an incorrect type may defeat a safeguard (for example, in the case of some lithium battery types).
- Do not dispose of the battery into fire or a hot oven, or mechanically crush or cut the battery, which may result in an explosion.
- Do not leave the battery in an extremely high temperature surrounding environment, which may result in an explosion or the leakage of flammable liquid or gas.
- Do not subject the battery to extremely low air pressure, which may result in an explosion or the leakage of flammable liquid or gas.
- Dispose of used batteries according to the instructions.

# Handheld Thermography Camera HIKMICRO M Series User Manual

---

- Use the battery provided by a qualified manufacturer. Refer to the product specification for detailed battery requirements.
- DO NOT charge other battery types with the supplied charger. Confirm there is no flammable material within 2 m of the charger during charging.
- When the device is powered off and the RTC battery is full, the time settings can be kept for 6 months.
- The lithium battery voltage is 3.7 V, and the battery capacity is 5000 mAh.
- The battery is certified by UL2054.

## Maintenance

- If the product does not work properly, please contact your dealer or the nearest service center. We shall not assume any responsibility for problems caused by unauthorized repair or maintenance.
- Wipe the device gently with a clean cloth and a small quantity of ethanol, if necessary.
- If the equipment is used in a manner not specified by the manufacturer, the protection provided by the device may be impaired.
- Please notice that the current limit of USB 3.0 PowerShare port may vary with the PC brand, which is likely to result in incompatibility issue. Therefore, it's advised to use regular USB 3.0 or USB 2.0 port if the USB device fails to be recognized by PC via USB 3.0 PowerShare port.

## Using Environment

- Make sure the running environment meets the requirement of the device. The operating temperature shall be -10°C to 50°C (14°F to 122°F), and the operating humidity shall be 95% or less.
- DO NOT expose the device to high electromagnetic radiation or dusty environments.
- DO NOT aim the lens at the sun or any other bright light.
- When any laser equipment is in use, make sure that the device lens is not exposed to the laser beam, or it may burn out.
- The device is suitable for indoor conditions.
- The pollution degree is 2.
- Overvoltage category: 0 for Handheld Thermography Camera.
- Overvoltage category: II for power adapter.

## Calibration Service

Please contact the local dealer for the information on maintenance points. For more detailed calibration services, please visit <https://www.hikmicrotech.com/en/support/>.

## Technical Support

The <https://www.hikmicrotech.com/en/contact-us/> portal will help you as a HIKMICRO customer to get the most out of your HIKMICRO products. The portal gives you access to

our support team, software and documentation, service contacts, etc.

## Emergency

- If smoke, odor, or noise arises from the device, immediately turn off the power, unplug the power cable, and contact the service center.

## Laser Light Supplement Warning



- Warning: The laser radiation emitted from the device can cause eye injuries, burning of skin or inflammable substances. Prevent eyes from direct laser. Before enabling the Light Supplement function, make sure no human or inflammable substances are in front of the laser lens. The wave length is 650 nm, the maximum power is 1 mW, and the beam divergence is 1 mrad. The laser meets the IEC 60825-1:2014, EN 60825-1: 2014 + A11: 2021 and EN 50689: 2021 standard.
- Instantaneous exposure to this class 2 laser product is safe, but gazing at this laser product may cause dizziness, flash blindness and visual afterimage. Move your head away or close your eyes to avoid the laser radiation. Besides, prevent eyes from direct laser and wear a pair of goggles for your safety. The operating wavelength of the eyewear should be longer than laser peak wavelength and its optical density should be higher than OD5+.
- DO NOT maintain the camera when it is powered on, or it may cause electric shock! If the product does not work properly, please contact your dealer or the nearest service center. We shall not assume any responsibility for problems caused by unauthorized repair or maintenance.
- Laser maintenance: It is not necessary to maintain the laser regularly. If the laser does not work, the laser assembly needs to be replaced in the factory under warranty. Keep the device power off when replacing laser assembly. Caution-Use of controls or adjustments or performance of procedures other than those specified herein may result in hazardous radiation exposure.

## Limited Warranty

Scan the QR code for the product warranty policy.



## **Manufacture Address**

Room 313, Unit B, Building 2, 399 Danfeng Road, Xixing Subdistrict, Binjiang District,  
Hangzhou, Zhejiang 310052, China

Hangzhou Microimage Software Co., Ltd

COMPLIANCE NOTICE: The thermal series products might be subject to export controls in various countries or regions, including without limitation, the United States, European Union, United Kingdom and/or other member countries of the Wassenaar Arrangement.

Please consult your professional legal or compliance expert or local government authorities for any necessary export license requirements if you intend to transfer, export, re-export the thermal series products between different countries.

# Contents

Chapter 1 Overview .....	1
1.1 Device Description.....	1
1.2 Main Function .....	1
1.3 Appearance.....	2
Chapter 2 Preparation .....	6
2.1 Charge Device.....	6
2.1.1 Charge Device via Charging Base .....	6
2.1.2 Charge Device via Cable Interface .....	8
2.2 Power On/Off .....	8
2.2.1 Set Auto Power-off Duration.....	8
2.3 Sleep and Wake .....	9
2.4 Operation Method.....	9
2.5 Menu Description .....	10
Chapter 3 Display Settings.....	13
3.1 Focus Lens.....	13
3.2 Set Screen Brightness.....	14
3.3 Set Auto-Rotation .....	14
3.4 Set Display Mode.....	14
3.5 Switch and Manage Palettes.....	15
3.5.1 Set Alarm Mode Palettes .....	18
3.5.2 Set Focus Mode Palettes.....	20
3.6 Adjust Display Temperature Range .....	21
3.6.1 Level Only Adjustment in Manual Mode .....	22
3.6.2 Level or Span Adjustment in Manual Mode .....	23
3.7 Set Live SuperIR.....	24
3.8 Set Macro Mode .....	24
3.9 Set Color Distribution .....	24

3.10 Adjust Digital Zoom .....	25
3.11 Display OSD Info.....	26
<b>Chapter 4 Temperature Measurement .....</b>	<b>27</b>
4.1 Set Measurement Parameters .....	27
4.1.1 Set Unit .....	28
4.2 Set Image Measurement .....	29
4.3 Set Measurement Tool.....	29
4.3.1 Measure by Custom Spot .....	30
4.3.2 Measure by Line.....	31
4.3.3 Measure by Rectangle.....	32
4.3.4 Measure by Circle .....	33
4.3.5 Measure $\Delta T$ and $\Delta T$ Alarm .....	35
4.4 Temperature Alarm .....	36
4.4.1 Set Alarms for Exceptional Temperatures .....	36
4.5 Clear All Measurements .....	37
<b>Chapter 5 Condensation Alarm .....</b>	<b>38</b>
<b>Chapter 6 Picture and Video .....</b>	<b>39</b>
6.1 Capture Images .....	39
6.2 Record Video.....	42
6.3 Set File Naming Rule .....	44
6.4 View and Manage Local Files.....	44
6.4.1 Manage Albums.....	45
6.4.2 Manage Files.....	45
6.4.3 Edit Images .....	46
6.4.4 Import and Manage Tag Note Templates .....	48
6.5 Export Files .....	49
6.5.1 Export Files to PC .....	49
6.5.2 Export Files to Mobile Devices .....	50
6.5.3 Export Files via Bluetooth .....	50

Chapter 7 Thermal View Mobile Client Connection .....	52
7.1 Connect APP via Device WLAN .....	52
7.2 Connect APP via Device Hotspot.....	52
Chapter 8 Connect Device to Wi-Fi .....	54
Chapter 9 Set Device Hotspot.....	55
Chapter 10 Pair Bluetooth Devices .....	57
Chapter 11 Cast Device Screen to PC .....	58
Chapter 12 Light Settings .....	59
12.1 Set LED Light .....	59
12.2 Set Laser .....	59
Chapter 13 Maintenance.....	60
13.1 View Device Information.....	60
13.2 Set Date and Time.....	60
13.3 Upgrade Device .....	60
13.3.1 Upgrade Device by Upgrade File .....	60
13.3.2 Upgrade Device by APP .....	61
13.4 Restore Device.....	61
13.5 Initialize Memory Card.....	61
13.6 Save and Export Log .....	62
13.7 About Calibration .....	62
Chapter 14 FAQ .....	63



# Chapter 1 Overview

## 1.1 Device Description

Thermographic Handheld Camera is a device with both visual images and thermal images. It can measure temperature, record videos, take snapshots, trigger alarms, and it can connect to client software via Wi-Fi or hotspot. The built-in high-sensitivity IR detector and high-performance sensor detects the variation of temperature and measure the real-time temperature.

The picture-in-picture technique of the camera and the fusion of visual view and thermal view, enhances the details of the images display. It supports multiple color palettes types for temperature display. It helps to find the risky part and lower your property loss, but it can not be used for human body temperature test.

The device is easy to use, and adopts ergonomic design. It is widely applied to substations, electricity prevention detection of companies, and reconnaissance survey of construction field.

## 1.2 Main Function

### Temperature Measurement

Device detects the real-time temperature, and display it on the screen.

### Storage

Device is equipped with memory module to store videos, snapshots, and important data.

### Fusion

Device can display fusion of thermal view and optical view.

### Live SuperIR

Device supports the function during live view to enhance image quality and offer more target details. A **SuperIR** icon displays in the image when the function is ON.

---

### Note

The function is supported by certain models in the series. See the actual device for reference.

---

### Palettes

Device supports multiple color palettes for temperature display. You can also set palettes

---

for a specific temperature range in alarm mode palettes and focus mode palettes to make it prominent from the rest.

### Condensation Alarm

Device detects target humidity and marks the area of humidity higher than the set threshold with green.

---

#### Note

Condensation alarm is only supported by certain models.

---

### Client Software Connection

- Mobile Phone: Use HIKMICRO Viewer to view live image, capture snapshots, and record videos on your phone. You can also, analyze pictures offline, generate and share a report via the app.

Search HIKMICRO Viewer in your APP store to download the APP.

- PC: Use HIKMICRO Analyzer to analyze pictures offline professionally, generate a custom format report on your PC, and browse live view of the device. Download the client software from <https://www.hikmicrotech.com/en/industrial-products/hikmicro-analyzer-software.html>

### Bluetooth

Device can be connected to headset via Bluetooth, and you can hear the voice in the recording or capture. Besides, the device can be connected to mobile phones with Android system via Bluetooth, and you can transmit image files to the phone.

### Digital Zoom

Device supports digital zoom from 1.0× to 8.0×.

### LED Light

LED light supplement makes the device a torch in required scenarios.

### Laser Light

Long-distance laser light supplement.

## 1.3 Appearance

---

#### Note

The appearances of different models may vary. Please take the actual product for reference.

---

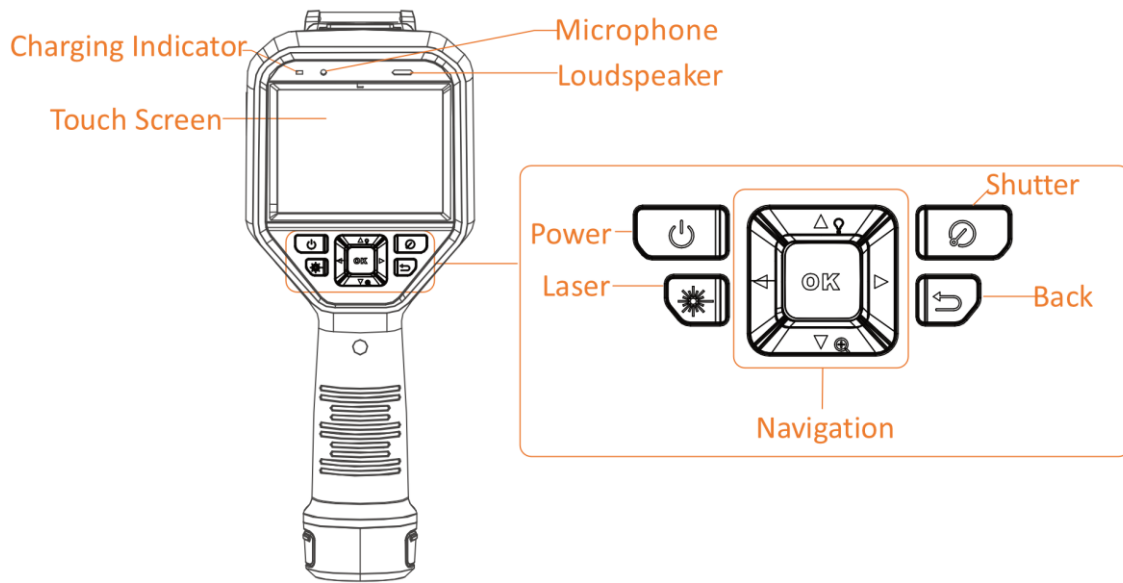

Figure 1-1 Appearance (Front View)

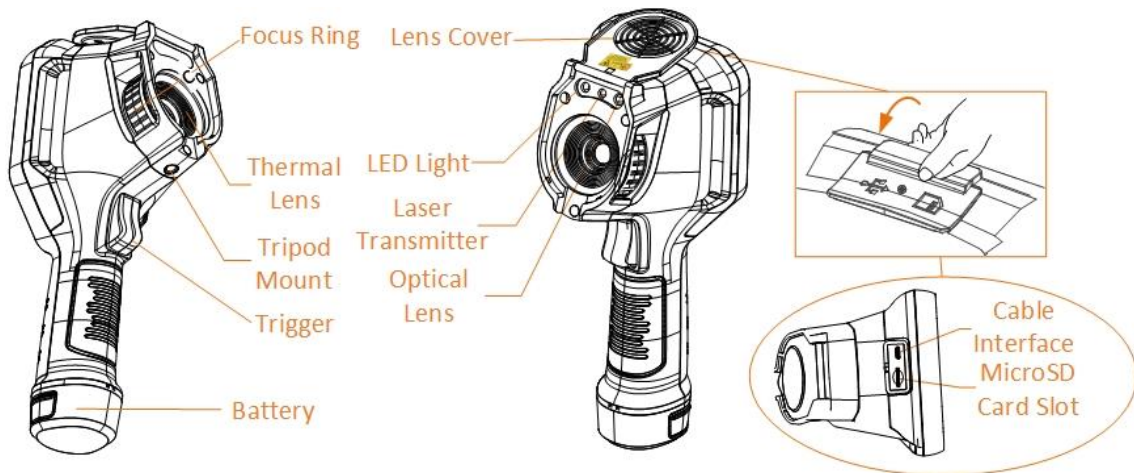

Figure 1-2 Appearance (Side View) I

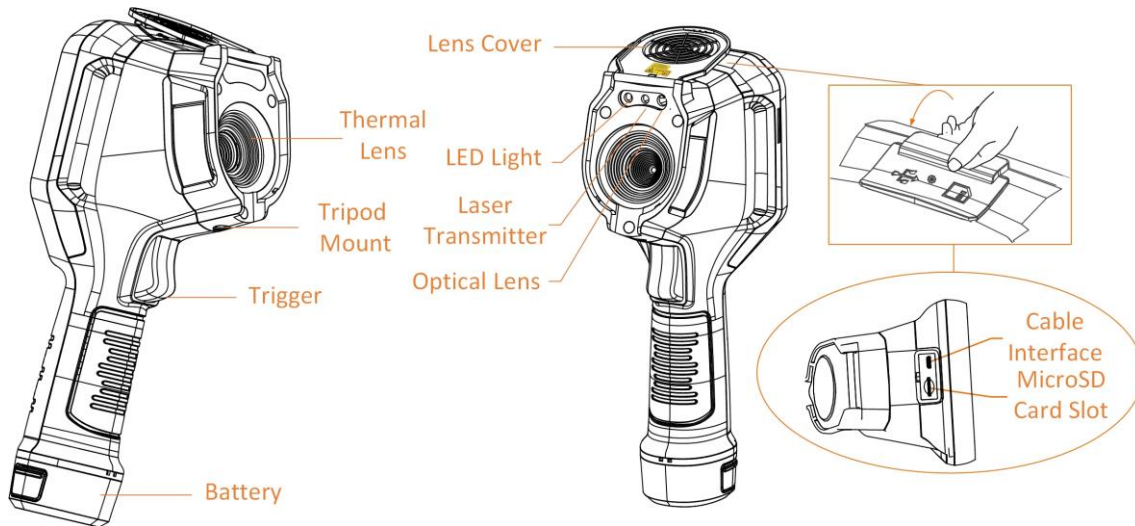

Figure 1-3 Appearance (Side View) II

**Note**

The warning sign is inside the lens cover.

Table 1-1 Interface Description

Component	Function
Laser Button	Hold the button to turn on laser, and release the button to turn off laser.
Navigation Button	Menu Mode: <ul style="list-style-type: none"> <li>• Press <math>\Delta</math>, <math>\nabla</math>, <math>\triangleright</math> and <math>\triangleleft</math> to select parameters.</li> <li>• Press <math>\triangleright</math> to enter the submenu.</li> <li>• Press <math>\triangleleft</math> to return to the previous menu.</li> <li>• Press <math>\text{OK}</math> to confirm.</li> </ul>
	Non-Menu Mode: <ul style="list-style-type: none"> <li>• Press <math>\Delta</math> to turn on/off the LED light.</li> <li>• Press <math>\nabla</math> to start digital zoom.</li> </ul>
Shutter Button	Cover the lens, and press to perform the correction.
Back Button	Exit the menu or return to previous menu.
Focus Ring	Adjust lens to make the image clear. Refer to <i>Focus Lens</i> .
	<p><b>Note</b></p> <p>Only supported by certain models.</p>

---

## Handheld Thermography Camera HIKMICRO M Series User Manual

---

Component	Function
Trigger	<ul style="list-style-type: none"><li>• Menu Mode: Pull the trigger to return to the live view interface.</li><li>• Non-Menu Mode: Pull the trigger to capture snapshots. Hold the trigger to record videos.</li></ul>
Cable Interface	Charge the device or export files with USB type-A to type C cable.

 **Caution**

The laser radiation emitted from the device can cause eye injuries, burning of skin or inflammable substances. Before enabling the light supplement function, make sure no human or inflammable substances are in front of the laser lens.

## Chapter 2 Preparation

### 2.1 Charge Device

---

#### Caution

The built-in cell battery that powers the real time clock (RTC) of the device may drain during longtime transportation or storage. It is recommended to recharge the RTC battery for the well-functioning of the device clock.

To fully charge the RTC battery, the following requirements should be met:

- The rechargeable lithium batteries should be installed on the device.
  - The device should keep working for more than 8 hours before shutting down.
- 

#### Note

In the first use, charge the device for more than 4 hours in the power-off status.

---

### 2.1.1 Charge Device via Charging Base

#### Steps

---

#### Note

Please charge the device with the cable and power adapter supplied by the manufacturer (or according to the input voltage from the specifications).

---

1. Hold the device, and press both battery lock catches of the device.

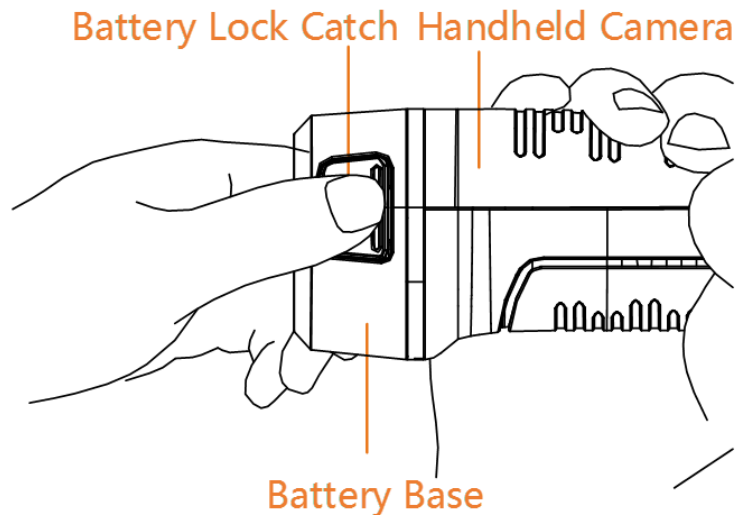

**Figure 2-1 Remove Battery**

2. Hold the lock catches, and draw the battery base to take out the battery.
3. Insert the battery into the charging base. You can see the charging status via the pilot lamp on the charging base.

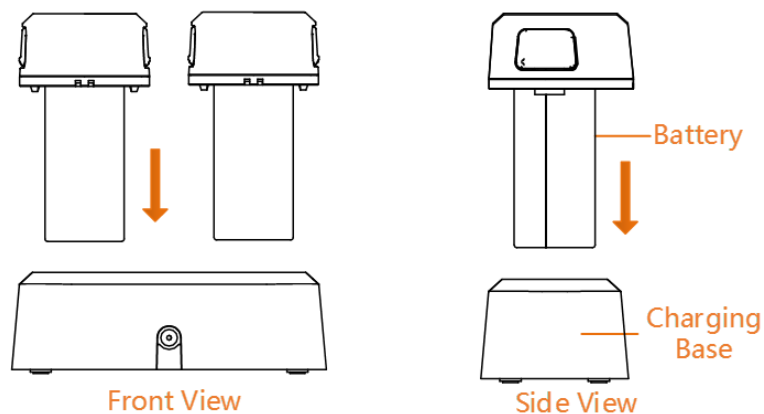

**Figure 2-2 Charge Battery**

4. When the battery is fully charged, draw the battery from the charging base.
5. Align the ribbed piece on battery with the notch of the device, and insert battery into the device.

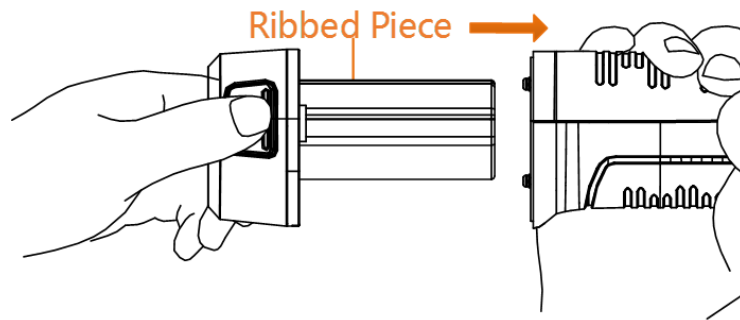

Figure 2-3 Insert Battery

## 2.1.2 Charge Device via Cable Interface

### Before You Start

Please make sure the battery is installed before charging.

### Steps

1. Open the top cover of the device.
2. Plug the Type-C male connector of the charging cable to the device and the other type-A connector to power adapter.

---

### Note

The power delivered by the charger must be between min 9.8 Watts required by the radio equipment, and max 10 Watts in order to achieve the maximum charging speed.

---

## 2.2 Power On/Off

### Power On

Remove the lens cover, and hold  for over three seconds to turn on the device. You can observe the target when the interface of the device is stable.

---

### Note

It may take at least 30 s until the device is ready for using when you power on it.

---

### Power Off

When the device is turned on, hold  for three seconds to power off the device.

### 2.2.1 Set Auto Power-off Duration

Go to **Settings > Device Settings > Auto Power-off** to set the automatic shutdown time for



device as required.

## 2.3 Sleep and Wake

Sleep and wake function is used to save energy and increase battery time. The function is only supported by certain models of this series.

### Sleep and Wake Manually

Press  to enter sleep mode and press it again to wake the device up.

### Set Auto Sleep

In live view, press  to call the main menu. Go to **Settings > Device Settings > Auto Sleep** to set waiting time before auto sleep. When there is no button pressing or screen tapping operation on device for more than the set waiting time, device enters sleep mode automatically.

Press  to wake the device up.

### Device Sleep, Scheduled Capture and Video Recording

When the device is recording a video clip or on scheduled capturing, auto sleep will not be triggered. However, press  will stop the video recording or scheduled capture and force the device into sleep mode.

## 2.4 Operation Method

The device supports both touch-screen control and button control.

### Touch-screen control

Tap on the screen to set parameters and configurations.

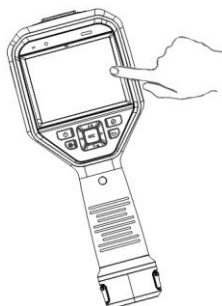

Figure 2-4 Touch-screen Control

### Button control

Press the navigation buttons to set parameters and configurations.

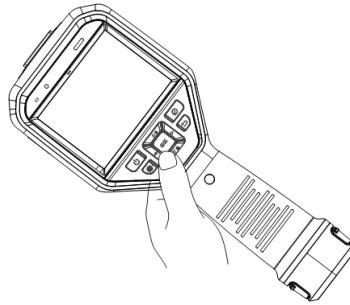

Figure 2-5 Button Control

- Press  $\Delta$ ,  $\nabla$ ,  $\triangleleft$ , and  $\triangleright$  to select parameters.
- Press  $\triangleright$  to enter the submenu.
- Press  $\triangleleft$  to return to the previous menu.
- Press  $\text{OK}$  to confirm.

## 2.5 Menu Description

### Live View Interface

Device screen displays the live view of thermal camera after starting-up.

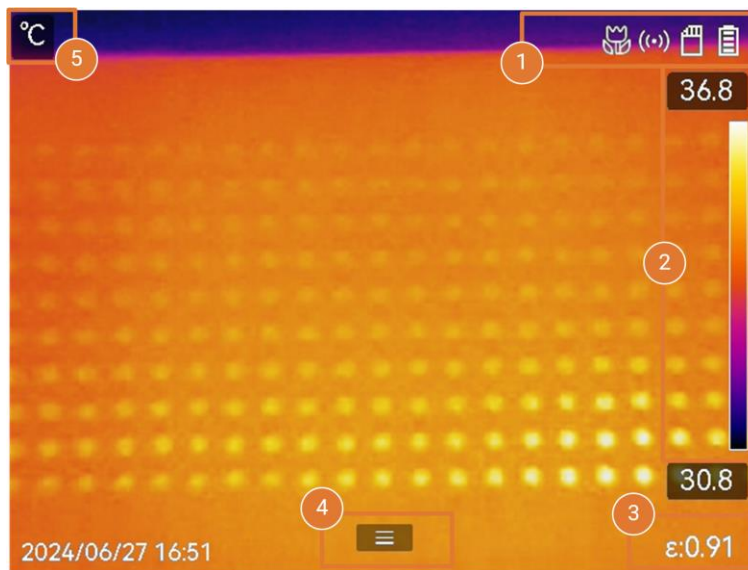





Figure 2-6 Live View Interface

Table 2-1 Live View Interface Description

No.	Descriptions
1	Status bar, where device working status, such as, battery and connections, are displayed.
2	Palette bar and display temperature range. The upper and lower values of

No.	Descriptions
	<p>the palette bar represent the max. temperature and the min. temperature of the current display temperature range respectively.</p> <hr/> <p><b>Note</b></p> <ul style="list-style-type: none"> <li>• If a "~" appears before a temperature value, it means that your device is not well prepared for accurate temperature measurement. Take target temperatures when the sign disappears.</li> <li>• It is available to show or hide the palettes bar in live view. Tap  &gt; <b>Display Settings &gt; Temperature Scale.</b></li> </ul> <hr/>
3	Shows current target emissivity.
4	Main menu icon. Press  or tap  to call main menu.
5	Shows current temperature values and unit.

## Main Menu

Supported operations in the main menu from left to right are settings, local file browsing and managing, display mode configuration, temperature measurement, palettes changing, and level & span.



Figure 2-7 Main Menu

## Swipe-down Menu

In live view interface, swiping on screen from upper to lower to call the swipe-down menu. With this menu, you can turn on/off device function, change display theme, and adjust screen brightness.

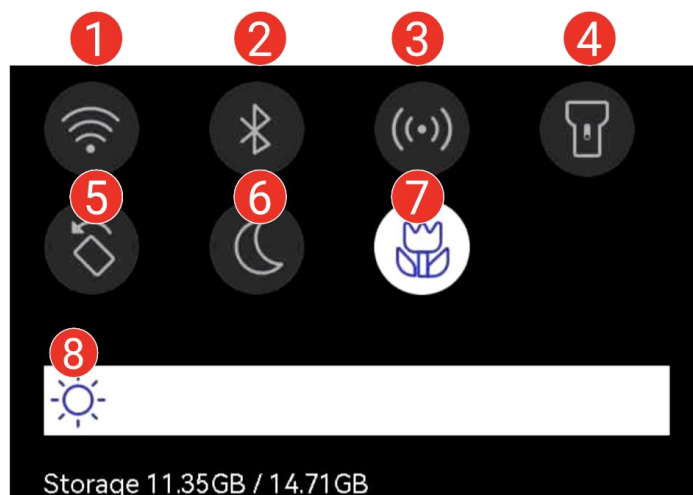

Figure 2-8 Swipe-down Menu

Table 2-2 Swipe-down Menu Description

No.	Descriptions
1	Tap once to turn on/ off Wi-Fi. Tap and hold to enter Wi-Fi configuration interface. For Wi-Fi configuration, see <i><u>Connect Device to Wi-Fi</u></i> for instructions.
2	Tap once to turn on/ off Bluetooth. Tap and hold to enter Bluetooth configuration interface. For Bluetooth configuration, see <i><u>Pair Bluetooth Devices</u></i> for instructions.
3	Tap once to turn on/ off hotspot. Tap and hold to enter hotspot configuration interface. For hotspot configuration, see <i><u>Set Device Hotspot</u></i> for instructions.
4	Turn on/ off LED light.
5	Turn on/off auto rotation, and the status bar, main menu and temperature scale shift from the horizontal direction to the vertical direction. See <i><u>Set Auto-Rotation</u></i> for instructions.
6	Switch themes. Day and night are supported.
7	Turn on/off the macro mode.
8	Adjust screen brightness.

## Chapter 3 Display Settings

---

### Note

Your device will periodically perform a self-calibration to optimize image quality and measurement accuracy. In this process the image will pause briefly and you'll hear a "click" as a shutter moves in front of the detector. The self-calibration will be more frequent during start up or in very cold or hot environments. This is a normal part of operation to ensure optimum performance for your device.

---

### 3.1 Focus Lens

Adjust the lens focal length properly before you set any other configurations, or it may affect the image display and temperature accuracy.

#### Steps

1. Power on the device.
2. Aim the device lens to the appropriate scene.
3. Adjust the focus ring clockwise or counterclockwise, see the figure below.

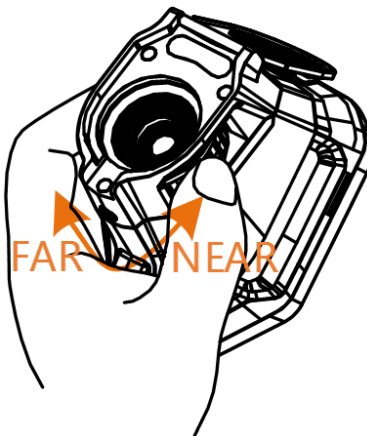



Figure 3-1 Focus Lens

### Note

- Adjusting focal length is only supported by certain models. Please take the actual product for reference.
- DO NOT touch the lens to avoid affecting the display effect.



## 3.2 Set Screen Brightness

Call the swipe-down menu, or go to **Settings > Device Settings > Screen Brightness**. Swipe the brightness bar or press /  to adjust the screen brightness.

## 3.3 Set Auto-Rotation

The device supports display auto-rotation where the status bar, shortcut bar and main menu shift from the horizontal direction to the vertical direction.

Switch on the auto-rotation function as follows:

- In live view, swipe down the screen to enter the swipe-down menu, and tap  .
- In live view, press  or tap  to call main menu, and go to **Settings > Device Settings > Auto-Rotation**.

## 3.4 Set Display Mode

You can set the thermal/visual view of the device. **Thermal, Fusion, PIP, Visual, and Blending** are selectable.

### Steps

1. Select  from the main menu.
2. Tap on the icons to select a display mode.



In **Thermal** mode, the device displays the thermal view.



In **Fusion** mode, the device displays the combined view of thermal channel and visual channel.

**Parallax Correction** adjusts the overlap effect at different distances. The images from the two channels overlap best at the set distance.



In **PIP** (Picture in Picture) mode, the device displays thermal view inside the visual view.

---

### Note

Select **PIP**, and enter PIP setting interface.

- Adjust position: Tap the PIP view, and drag it to the target position on screen.
- Adjust size: Tap one of the PIP view corners, and drag it to adjust the size.



In **Visual** mode, the device displays the visual view.







In **Blending** mode, the device displays the mixture view of thermal and visual channels. Press navigation buttons to select the **Level**. The lower the value is, the denser the visual effect is.

3. Press  to exit.

## 3.5 Switch and Manage Palettes

Palettes are color combination standing for different temperatures. Device offers several kinds of palettes serving different purposes. You can switch and manage frequently used palettes.

### Steps

1. Press  to call the main menu.
2. Select  from the main menu to show the frequently used palette types.
3. Select  to show all supported palette types. Select a palette type and press  to switch.

### Common Palettes

When you select a common palette type, the whole live image switch to the selected color combination. Available common palettes are as follows.

#### White Hot

The hot part is light-colored in view.

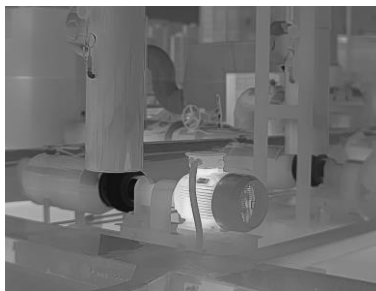

Figure 3-2 White Hot Example

#### Black Hot

The hot part is black-colored in view.



**Figure 3-3 Black Hot Example**

## **Rainbow**

The target displays multiple colors, it is suitable for scene without obvious temperature difference.

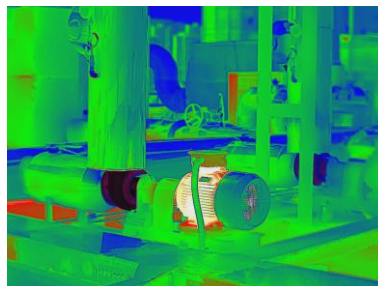

**Figure 3-4 Rainbow Example**

## **Ironbow**

The target is colored as heated iron.

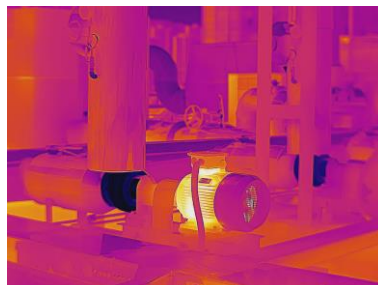

**Figure 3-5 Ironbow Example**

## **Red Hot**

The hot part is red-colored in view.





Figure 3-6 Red Hot Example

**Fusion**

The hot part is yellow-colored and the cold part is purple-colored in view.

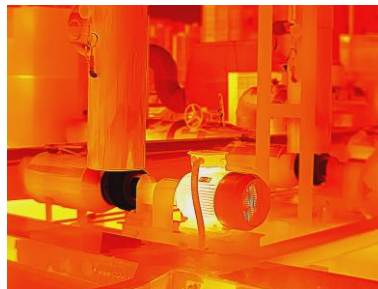

Figure 3-7 Fusion Example

**Rain**

The hot part in the image is colored, and the else is blue.

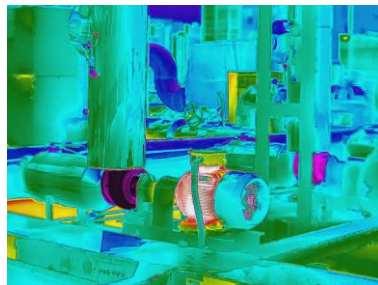

Figure 3-8 Rain Example

**Blue Red**

The hot part in the image is colored red, and the else is blue.

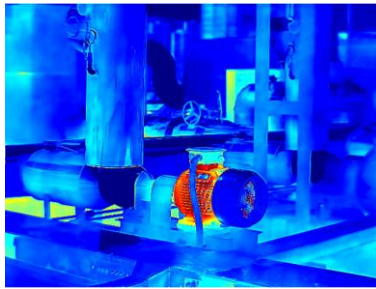

Figure 3-9 Blue Red Example

## Focus Mode Palettes



Focus mode palettes allows to mark the targets of certain temperature range with fusion palettes and the others with white hot palettes. ***Set Focus Mode Palettes*** for instructions.

## Alarm Mode Palettes

Alarm mode palettes allows to mark targets of certain temperature range with a specific color and the rest with white hot palettes. See ***Set Alarm Mode Palettes*** for instructions.

## Condensation Alarm

Condensation alarm marks the surface where the relative humidity exceeds the set threshold. See ***Condensation Alarm*** for instructions.

4. Set frequently used palettes.
  - 1) Select .
  - 2) Check palette types.
  - 3) Press  to save and exit.

## 3.5.1 Set Alarm Mode Palettes

Alarm mode palettes allows to mark the targets of certain temperature range with a different color from the rest.

### Steps











1. Select  from the main menu.
2. Tap the icons to select an alarm mode palette type.

Table 3-1 Icon Description

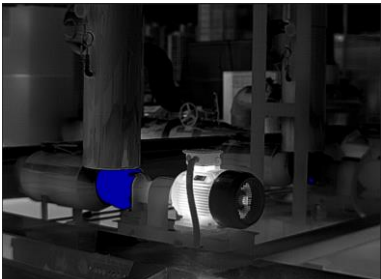
Icon	Alarm Mode	Description	Example
	Above Alarm	Set the alarm temperature, and the targets with the temperature higher than the set value are displayed in red.	
	Below Alarm	Set the alarm temperature, and targets with the temperature lower than the set value are displayed in blue.	
	Interval Alarm	Set the alarm temperature section (e.g., 90 °C to 150 °C), and targets with the temperature in the range are displayed in yellow.	
	Insulation Alarm	<p>With user-input <b>Indoor Temp.</b> and <b>Outdoor Temp.</b>, the device calculates the insulation level of room/building during detection. If suspected area with insulation level lower than the set value, the area is mark with cyan.</p> <p>In practice, the <b>Insulation Level</b> is recommended to be between 60 to 80. Larger number means higher insulation demand.</p> <hr/> <p> <b>Note</b> Insulation detection should be conducted indoor.</p> <hr/>	

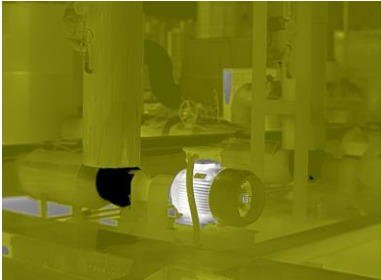
3. Set a temperature range.
  - Press  $\Delta$  and  $\nabla$  to select between upper limit and lower limit. Press  $\triangleleft$  and  $\triangleright$  to adjust the temperature.
  - Tap on the screen to select an interest area. The device automatically adjusts the upper and lower temperature limit of the selected scene. Press  $\triangleleft$  and  $\triangleright$  to fine-tune the temperature.
4. Press  to exit.

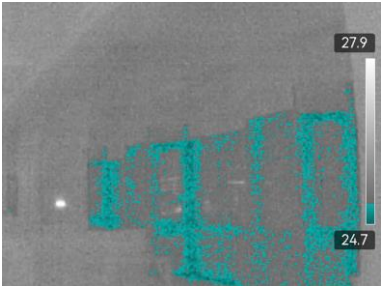



## 3.5.2 Set Focus Mode Palettes

Focus mode palettes allows to mark the targets of certain temperature range with fusion palettes and the others with white hot palettes.

### Steps

1. Select **Palettes** from the main menu.
2. Tap the icons to select an alarm rule type.

Table 3-2 Icon Description

Icon	Palettes Mode	Description	Example
	Above Focus	Set the temperature threshold, and the targets with the temperature higher than the set value are displayed with fusion palettes.	
	Below Focus	Set the temperature threshold, and targets with the temperature lower than the set value are displayed with fusion palettes.	

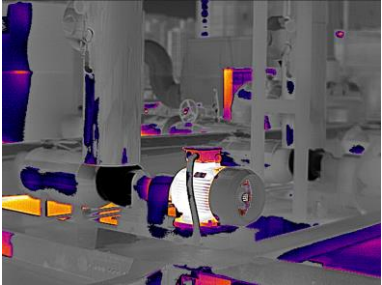



Icon	Palettes Mode	Description	Example
	Interval Focus	Set the temperature range (e.g., 90 °C to 150 °C), and targets in the range are displayed with fusion palettes.	

3. Set a temperature range.
  - Press  $\Delta$  and  $\nabla$  to select between upper limit and lower limit. Press  $\triangleleft$  and  $\triangleright$  to adjust the temperature.
  - Tap on the screen to select an interest area. The device automatically adjusts the upper and lower temperature limit of the selected scene. Press  $\triangleleft$  and  $\triangleright$  to fine-tune the temperature.
4. Press  to exit.

## 3.6 Adjust Display Temperature Range

Set a temperature range for screen display and the palette only works for targets within the temperature range. You can adjust the temperature range.

### Steps

1. Select an adjustment mode.
  - 1) In live view, press  to call the main menu.
  - 2) Tap .
  - 3) Choose **Auto** or **Manual**.
2. Adjust the display temperature range.
 

**Auto Adjustment**      Select . The device adjusts display temperature range according to the actual targets temperature automatically.

**Manual Adjustment**      There are two modes to manually adjust display temperature range. You can go to **Settings > Temp Measurement Settings > Manual Level and Span Mode** to choose the preferred mode. See *Level Only Adjustment in Manual Mode* and *Level or Span Adjustment in Manual Mode* for more instructions.
3. Optional: Tap **Image Mode** and **Palettes** icons to change the settings during level and span manual adjustment.

## Note

In **Visual** display mode, **Level & Span** cannot be switched on using the shortcut key. In **Level & Span**, the size and position of PIP view are not configurable.

---

## 3.6.1 Level Only Adjustment in Manual Mode

Manually adjust the maximum temperature and the minimum temperature respectively to expand or reduce the temperature range.

### Before You Start

Go to **Settings > Temp Measurement Settings > Manual Level and Span Mode** and enable **Level Only**.

### Steps







1. In live view, press  to call the main menu.
2. Tap  to select **Manual** mode.
3. Tap on an interest area of the screen.  
A circle is displayed around the area, and the temperature range readjusts to show as many details of the area as possible, according to the selected area.
4. Fine-tune the temperature range for display.
  - 1) Press  or , or tap on the value on screen to lock or unlock a value.
  - 2) Press  or , or scroll the adjustment wheel on the screen to fine-tune the maximum temperature and the minimum temperature respectively.



Figure 3-10 Level Only Adjustment

5. Press  to confirm.

## Note

In **Manual** level & span mode, press  on the left side of temperature scale to quickly adjust the temperature range.

---



### 3.6.2 Level or Span Adjustment in Manual Mode

Increase or decrease the individual values of both the maximum temperature and the minimum temperature while remaining the same temperature range. You can also expand or reduce the temperature range evenly.

#### Before You Start

Go to **Settings > Temp Measurement Settings > Manual Level and Span Mode** and enable **Level or Span**.

#### Steps

1. In live view, press  to call the main menu.
2. Tap  to select **Manual** mode.
3. Tap on an interest area of the screen.  
A circle is displayed around the area, and the temperature range readjusts to show as many details of the area as possible, according to the selected area.
4. Fine-tune the temperature range for display.
  - 1) Press  $\Delta$  or  $\nabla$  to increase or decrease the individual values of both maximum temperature and the minimum temperature while remaining the same temperature range.
  - 2) Press  $\triangleleft$  or  $\triangleright$  to expand or reduce the temperature range evenly.

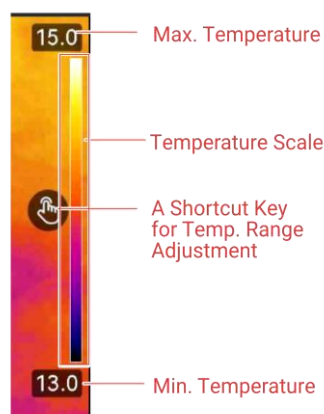



Figure 3-11 Level or Span Adjustment

5. Press  to confirm.

---

#### Note

In **Manual** level & span mode, press  on the left side of temperature scale to quickly adjust the temperature range.

---

## 3.7 Set Live SuperIR

It adopts super resolution technology in live streaming, making live image clearer and with more details.

Go to **Settings > Capture Settings > SuperIR** to turn on the function. The **SuperIR** icon appears in the lower right corner of the screen.

---

### Note

- **SuperIR** only takes effect when the display mode is **Thermal** and level and span is set to **Auto**. If you change display mode or level and span mode when the **SuperIR** is ON, the function is automatically OFF without notice.
  - **SuperIR** in live streaming and in captured radiometric images share the same ON/OFF switch. Some models in this series may not support it in live streaming, take your actual device for reference.
- 



## 3.8 Set Macro Mode

Macro mode is used when users perform close inspect on electronic parts such as PCBs. A macro lens should be mounted and Macro Mode be enabled before using.

### Before You Start

Purchase a macro lens applicable to your device in advance.

### Steps

1. Install the macro lens to your device. Refer to the user manual of your macro lens for instructions.
2. Press  and go to **Settings > Capture Settings > Macro Mode** to enable the function.
  - In macro mode, **Temperature Range, External Optics Transmittance, External Optics Temperature**, and digital zoom are not allowed to change.
  - Emissivity is set to default (0.91), adjustable.
3. Press  to return to live view, and inspect electronic components with the device. Macro mode icon  displays in the upper right corner.
4. Exit **Macro Mode** and dismount the macro lens after inspection. The parameter settings return to the status before macro mode.

## 3.9 Set Color Distribution

Color distribution function provides different image display effects in auto level & span. Liner and histogram color distribution modes can be selected for different application



scenes.

## Before You Start

Select **Auto** in level & span.

## Steps

1. Go to **Settings > Capture Settings > Color Distribution**.
2. Select a color distribution mode.
  - **Linear**: Linear mode is used to detect small high temperature targets in low temperature background. Linear color distribution enhances and displays more details of high temperature targets, which is good for checking small high temperature defective areas such as cable connectors.
  - **Histogram**: Histogram mode is used to detect temperature distribution in large areas. Histogram color distribution enhances high temperature targets and remains some details of low temperature objects in the area, which is good for discovering small low temperature targets such as cracks.
3. Return to previous menu to save the settings.

---

### Note

This function is only supported in auto level & span.

---

## Example

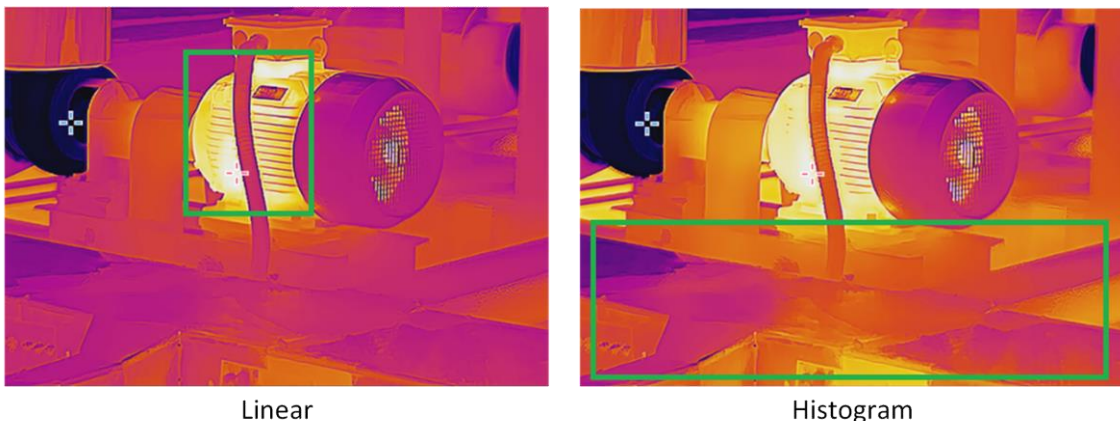
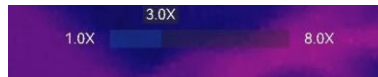

Figure 3-12 Color Distribution

## 3.10 Adjust Digital Zoom

In the live view interface, press  $\nabla$  to enter the digital zoom setting interface.

- Hold  $\triangleleft$  or  $\triangleright$  to zoom in or zoom out continuously.



**Figure 3-13 Adjust Zooming Ratio Continuously**

- Press ◀ or ▶ to fine-tune the zooming ratio.



**Figure 3-14 Fine-Tune Zooming Ratio**

- Tap the zooming ratio slider, and drag it to the left or right to adjust zooming ratio.

## 3.11 Display OSD Info

Go to **Settings > Display Settings** to enable the information on-screen display.

### Status Icon

The device status icons, for example, battery status, memory card, hotspot, etc.

### Time and Date

Device time and date.

### Parameters

Temperature measurement parameters, for example, target emissivity, temperature unit, etc.

### Brand Logo

The brand logo is a manufacturer logo displayed on the upper right corner of the screen. You can turn it off if not needed.

### Temperature Scale

Display the palettes bar and temperature range on the right side of the screen.

## Chapter 4 Temperature Measurement

The temperature measurement function provides the real-time temperature of the scene and display it on the left of your screen.

When reading the measurement results, you may sometimes find certain signs, for example, "~", displaying in front of the values. The meaning of these signs are explained in the following table.

**Table 4-1 Signs in Measurement Results**

Sign	Explanation
~	If a target temperature slightly exceeds the measurement range, the device gives an approximate result with a "~" showing in front of the value. For example, if a result displays as "~ 55 °C", it means that the target temperature is around 55 °C.
< or >	If a target temperature exceeds the measurement range and the device fails to get even an imprecise value of the target, "<" or ">" displays in front of a fixed value indicating that temperature of the target is lower or higher than the value. For example, if a result displays as "< -30.0 °C", it means that the target temperature is lower than -30.0 °C. If a result displays as "> 580.0 °C", it means that the target temperature is higher than 580.0 °C

### Note

Your device will periodically perform a self-calibration to optimize image quality and measurement accuracy. In this process the image will pause briefly and you'll hear a "click" as a shutter moves in front of the detector. The self-calibration will be more frequent during start up or in very cold or hot environments. This is a normal part of operation to ensure optimum performance for your device.

### 4.1 Set Measurement Parameters

You can set measurement parameters to improve the accuracy of temperature measurement.

#### Steps

1. Go to **Settings > Temp. Measurement Settings**.

## 2. Set Temperature Range, Emissivity, etc.

### Temperature Range

Select a temperature measurement range according to the temperature of your targets.

If you are testing a target of unknown temperature range or targets of different supported ranges, it is recommended to set it as **Auto Switch** and the device will switch from the ranges automatically.

### Emissivity

Set the emissivity of your target.

### Refl. Temp.

Reflect Temperature. If any object (not the target) of high temperature is in the scene, and the target emissivity is low, set the reflection temperature as the high temperature to correct the temperature effect.

### Ambient Temp.

The ambient temperature of the device.

### Distance

The distance between the target and the device. You can customize the target distance or select the target distance as **Near, Middle, or Far**.

### Humidity

Set the relative humidity of current environment.

### External Optics Transmittance

Set the optics transmittance of external optical material (e.g.: germanium window) to improve the temperature measuring accuracy.

### External Optics Temperature

Set temperature of the external optical material (e.g.: germanium window).

## 3. Return to previous menu to save the settings.

---

### Note

You can go to **Settings > Device Settings > Device Initialization > Remove All Measurement Tools** to initialize the temperature measurement parameters.

---

## 4.1.1 Set Unit

Go to **Settings > Device Settings > Unit** to set the temperature unit and distance unit.

## 4.2 Set Image Measurement

Device measures the temperature of the whole scene and can be managed to display the center, hot, and cold spot in the scene.

Press  to call the main menu and select  > . Select the desired spots to show their temperatures.

Table 4-2 Icon Description



Icon	Description
	Center spot of the scene (screen center). The temperature is displayed as <b>Cen XX</b> .
	Hot spot in the scene, which changes as the temperature or the scene changes. The temperature is displayed as <b>Max XX</b> .
	Cold spot in the scene, which changes as the temperature or the scene changes. The temperature is displayed as <b>Min XX</b> .



Figure 4-1 Image Measurements

## 4.3 Set Measurement Tool



You can set temperature measurement parameters to improve the accuracy of

temperature measurement.

## Before You Start

Set parameters such as **Humidity**, **External Optics Transmittance** and **Reflection Temperature**. For detailed explanations, see [Set Measurement Parameters](#).

## Steps

1. Press  to call the main menu.
2. Select  and press .
3. Select a type of temperature measurement tool

<b>Custom Spot</b>	For configuring custom spot tools, see <a href="#"><u>Measure by Custom Spot</u></a> .
<b>Line</b>	For the configuring line tools, see <a href="#"><u>Measure by Line</u></a> .
<b>Rectangle</b>	For the configuring rectangle tools, see <a href="#"><u>Measure by Rectangle</u></a> .
<b>Circle</b>	For the configuring circle tools, see <a href="#"><u>Measure by Circle</u></a> .
<b><math>\Delta T</math></b>	For the configuring $\Delta T$ tools, see <a href="#"><u>Measure <math>\Delta T</math> and <math>\Delta T</math> Alarm</u></a> .



## What to do next

Set temperature alarm, then alarm actions such as audible warning and flashing alarm will be triggered when the tested temperature exceeds the set alarm value. See [Temperature Alarm](#).

## 4.3.1 Measure by Custom Spot

The device can detect the temperature of a custom spot.

### Steps

1. Select .
2. Press  to add a custom spot.
3. Move the spot with the navigation buttons, or tap on the touch-screen to select a spot and move it.
4. Tap  to modify temperature measurement parameters.

#### Emissivity

Set the emissivity of your target.

#### Distance

Set the distance between the target and the device.

#### Temp.

Tap to display or hide the temperature measurement result.

5. Press .

---

### Note

If the tool-specific emissivity and distance are set, the measurement is conducted based on the parameters. Otherwise, the parameters set from **Settings > Temp. Measurement Settings** are used for measurements.

---

The temperature of custom spot (e.g. P1) displays P1: XX.

6. Repeat the above steps to set other custom spots.

---

### Note

- At most ten custom spots are supported.
  - Drag the spot list on the screen, or press navigation buttons to view the whole tool list.
- 

7. Optional: Modify the set custom spot tools, hide or display the tools and measurement results, etc.



Tap to enter the editing interface and modify temperature measurement parameters such as emissivity and distance.



Tap to hide or display the tool and measurement results.





Tap to delete the tool.

8. Press  to save and exit.

## 4.3.2 Measure by Line

### Steps

1. Select .
  2. Press  to generate a default line.
- 

### Note

Only one line tool is supported.

---

3. Move the line to the desired position.
    - Tap the line, and press the navigation buttons.
    - Tap the line on touch-screen and drag to change its position.
  4. Adjust the length of the line.
    - Tap the end of the line, and press navigation buttons to extend or shorten the line.
-

– Tap and drag the end of the line to extend or shorten it.

5. Tap  to modify temperature measurement parameters.

### Emissivity

Set the emissivity of your target.

### Distance

Set the distance between the target and the device.

### Max./Min./Average Temperature

Tap to enable the temperature types to display. The max. temperature, min. temperature, and average temperature of the line can be displayed on the left of the screen.

6. Press .

---

### Note

If the tool-specific emissivity and distance are set, the measurement is conducted based on the parameters. Otherwise, the parameters set from **Settings > Temp. Measurement Settings** are used for measurements.

---

7. Modify the set line tool, hide or display the tool and measurement results, etc.



Tap to enter the editing interface and modify temperature measurement parameters such as emissivity and distance.



Tap to hide or display the tool and measurement results.





Tap to delete the tool.

8. Press  to save and exit.

## 4.3.3 Measure by Rectangle

### Steps

1. Select .

2. Press  or tap  to generate a default rectangle.

3. Move the rectangle to the required position.

– Tap the rectangle, and press navigation buttons to move the rectangle up/down/left/right.

– Tap and drag the rectangle on touch-screen to move it to the required position.

4. Adjust the size of the rectangle.

– Tap one corner of the rectangle, and press navigation buttons to enlarge or contract the rectangle.



- Tap and drag the corner of the rectangle on touch-screen to enlarge or contract it.
5. Tap  to modify temperature measurement parameters.

### Emissivity

Set the emissivity of your target.

### Distance

Set the distance between the target and the device.

### Max./Min./Average Temperature

Tap to enable the temperature types to display. The max. temperature, min. temperature, and average temperature of the rectangle area can be displayed on the left of the screen.

6. Press  to save the settings.

---

### Note

If the tool-specific emissivity and distance are set, the measurement is conducted based on the parameters. Otherwise, the parameters set from **Settings > Measurement Settings** are used for measurements.

---

7. Repeat the above steps to set other rectangle tools.

---

### Note

At most five rectangle tools are supported.

---

8. Optional: Modify the rectangle tools, hide or display the tools and measurement results, etc.



Tap to enter the editing interface and modify temperature measurement parameters such as emissivity and distance.



Tap to hide or display the tool and measurement results.







Tap to delete the tool.

9. Press  to save and exit.

## 4.3.4 Measure by Circle

### Steps

1. Select .
2. Press  or tap  to generate a default circle.
3. Move the circle to the required position.

- Tap the circle, and press navigation buttons to move the circle up/down/left/right.
  - Tap and drag the circle on touch-screen to move it to the required position.
4. Adjust the size of the circle.
- Tap one point on the circle, and press navigation buttons to enlarge or contract the circle.
  - Tap and drag one point of the circle on touch-screen to enlarge or contract it.
5. Tap  to modify temperature measurement parameters.

### Emissivity

Set the emissivity of your target.

### Distance

Set the distance between the target and the device.

### Max./Min./Average Temperature

Tap to enable the temperature types to display. The max. temperature, min. temperature, and average temperature of the circle area can be displayed on the left of the screen.

6. Press  to save the settings.
- 

### Note

If the tool-specific emissivity and distance are set, the measurement is conducted based on the parameters. Otherwise, the parameters set from **Settings > Temp. Measurement Settings** are used for measurements.

---

7. Repeat the above steps to set other rectangle tools.
- 

### Note

At most five circle tools are supported.

---

8. Optional: Modify the circle tools, hide or display the tools and measurement results, etc.



Tap to enter the editing interface and modify temperature measurement parameters such as emissivity and distance.



Tap to hide or display the tool and measurement results.



Tap to delete the tool.

9. Press  to save and exit.
-

## 4.3.5 Measure $\Delta T$ and $\Delta T$ Alarm

By comparing the temperature difference ( $\Delta T$ ) between measurement tools, or between a measurement tool and a fixed temperature, device can recognize temperature exception more accurately and rapidly. This function is commonly applied to measure temperature-sensitive targets such as current transformers.

### Before You Start

Configure at least one temperature measurement tool.

- For configuring custom spot tools, see *Measure by Custom Spot*.
- For the configuring line tools, see *Measure by Line*.
- For the configuring rectangle tools, see *Measure by Rectangle*.
- For the configuring circle tools, see *Measure by Circle*.

### Steps

1. Select .
2. Add a  $\Delta T$  tool.
  - 1) Input a tool name for the  $\Delta T$  tool in **Name of Tool**.
  - 2) Select **Compared Object**.





---

#### Note

You can compare the temperature difference between different or the same measurement tools, between a measurement tool and a number, etc. If you select **Number** as a compared object, input the value manually.

---

- 3) Set **Alarming  $\Delta T$** .

When the detected  $\Delta T$  is greater than the set alarming  $\Delta T$ , device triggers alarms.
- 4) Tap **OK** to save the settings.
3. Optional: Repeat above steps to set other  $\Delta T$  tools.
4. Optional: Modify the  $\Delta T$  tools, hide or display the tools and measurement results, etc.
  -  Tap to enter the editing interface and modify  $\Delta T$  tool parameters such as emissivity and distance.
  -  Tap to hide or display the  $\Delta T$  tool and measurement results.
  -  Tap to delete the  $\Delta T$  tool.
5. Press  to save and exit.
6. Enable  **$\Delta T$  Alarm**.
  - 1) Go to **Settings > Temp Measurement Settings > Alarm Settings**.
  - 2) Tap to enable  **$\Delta T$  Alarm**.

## Note

If you do not enable  $\Delta T$  Alarm, the alarm linkages also take effect, but the  $\Delta T$  alarm information will not be uploaded to the center.

---

## 4.4 Temperature Alarm

When the temperature of targets triggers the set alarm, the device will perform configured actions, such as, flashing the rule frame, making an audible warning, or sending notification to the client software.

### 4.4.1 Set Alarms for Exceptional Temperatures

Alarm actions such as audible warning and flashing alarm are triggered when the tested temperature exceeds the set alarm value.

#### Steps

1. Go to **Settings > Temp Measurement Settings > Alarm Settings**.
  2. Tap to enable **Temperature Alarm**.
  3. Set the alarm parameters.
- 

## Note

Supported alarm linkages vary on different models. See the actual device for available options.

---

#### Alarm Threshold

When the tested temperature exceeds the threshold, the device sends alarm notification to the client software. It beeps if the audible warning is enabled. The rectangle flashes red if the rectangle tool is configured.

#### Alarm Linkage

- **Audible Warning:** The device beeps when target temperature exceeds the alarm threshold.
  - **Flashing Alarm:** The flash light flashes when target temperature exceeds the alarm threshold.
  - **Alarm Capture:** The device captures radiometric images when target temperature exceeds the alarm threshold.
  - **Min. Alarm Interval:** It controls the minimal time interval between two alarm
-

information uploading. It helps reduce repeated and frequent information receiving on the part of app and client software.

---

### Note

If you set rectangle and circle tools to measure temperature, the alarm threshold and linkage method settings only works in the measured areas. Otherwise, the parameters are valid for pixel-to-pixel temperature measurement (whole-screen temperature measurement).

---

## 4.5 Clear All Measurements

Tap  to clear all set temperature measurement tools.

## Chapter 5 Condensation Alarm

Condensation alarm marks the surface where the relative humidity exceeds the set threshold.

### Steps

1. Select **Palettes** from the main menu.
2. Tap on .
3. Set ambient temperature, air relative humidity and humidity threshold for the alarm.

### Threshold

The surface humidity threshold. Anywhere with higher humidity in the scene is marked with green.

### Relative Humidity

The relative humidity of the environment around the target. This parameter helps the device calculate target humidity more accurately.

Relative humidity changes as your location and weather condition change. Check and reset the parameter every time you use the function.

You can refer to the value of your weather APP.

### Ambient Temp.

The ambient temperature of the target. This parameter helps the device calculate target humidity more accurately.

The ambient temperature changes as your location and weather condition change.

Check and reset the parameter every time you use the function.

You can refer to the value of your weather APP.

4. Press **OK** to confirm the settings.

## Chapter 6 Picture and Video

Insert memory card into the device, and then you can record videos, capture images, and mark and save important data.

---

### Note

- Device does not support capturing or recording when the menu is shown.
  - When the device is connected to your PC, it does not support capturing or recording.
- For a new memory card, go to **Settings > Device Settings > Device Initialization** to initialize it before using.
- 

### 6.1 Capture Images

Operate the device to capture live images and save them in local albums.

#### Before You Start

Make sure that there is a working memory card mounted in your device. See [Appearance](#) to locate the memory card slot of your device.

#### Steps

1. Set a capture mode and pull **Trigger** in live view interface to capture images.

There are 2 modes available. Each mode requires different operations.

- 1) Go to **Settings > Capture Settings > Capture Mode**.
- 2) Select a mode.

#### Capture One Image

Pull **Trigger** once to capture one image.

#### Scheduled Capture

Set the **Interval** and **Number** of images for scheduled capture.

Pull **Trigger** in live view, and the device captures according to the set interval and number. Pull **Trigger** again or press  to stop capturing.







- 3) Press  to return to the live view interface.
- 4) Aim the lens to your target and pull **Trigger** to capture images.
  - Capture One Image: If **Edit before Saving** is NOT enabled (**Settings > Capture Settings**), the live image freezes and is saved in the default saving album. If **Edit before Saving** is enabled, the device enters the image editing interface.



Figure 6-1 Editing Image Before Saving

Table 6-1 Editing Options

No.	Descriptions
1	<p>Text Note</p> <p>Select text note and enter the editing page. Tap on screen to input content and press  to save.</p>
2	<p>Voice Note</p> <ul style="list-style-type: none"> <li>• Select voice note and enter voice recording page.</li> <li>• Press  or tap  to start recording. Press  or tap screen to stop recording.</li> <li>• <b>Optional:</b> You can tap to play the recording. If the voice note is unsatisfactory, tap to delete it. Repeat above steps to record again.</li> <li>• Press  to exit.</li> </ul>
3	<p>Scan QR Code</p> <ul style="list-style-type: none"> <li>• Select QR code and the device enters the scanning mode.</li> <li>• Aim the scanning frame at a QR code. Device reads the code and save the code information.</li> <li>• <b>Optional:</b> If the scanning fails, you can enter the code information using on-screen keyboard according to the prompt.</li> </ul>
4	<p>Edit Tag Note. Tag notes are predefined texts that can be added to the images quickly. Tag note template should be imported to the device before you can use it. See <i><u><a href="#">Import and Manage Tag Note Templates</a></u></i> for instructions.</p> <ul style="list-style-type: none"> <li>• Select <b>Tag Note</b>.</li> <li>• Select a tag name, and enter editing page.</li> <li>• Select one option if it is a single choice tag, or check desired</li> </ul>



No.	Descriptions
	<p>options for a multiple choice tag. Press <b>OK</b> to save.</p> <ul style="list-style-type: none"> <li>• Press <b>◀</b> or <b>▶</b> to switch to next or previous tag, and continue setting.</li> <li>• Press <b>↵</b> to exit.</li> </ul>
5	<p>Add Visual Picture Note. Up to 3 visual pictures are supported to save with the radiometric image, providing referential information of the detection scene.</p> <ul style="list-style-type: none"> <li>• Select <b>Picture Note</b> to start visual camera.</li> <li>• Aim at a target and pull <b>Trigger</b>. The image freezes.</li> <li>• Press <b>OK</b> or pull <b>Trigger</b> to save the capture and start next capture.</li> <li>• Repeat the steps to capture the second and the third picture. If you want to end capturing early, press <b>OK</b> in live visual camera interface to exit.</li> <li>• If you want to retake visual pictures, select <b>Picture Note</b> again and start over.</li> </ul>
6	<p>After all information added to the image, select <b>Save</b> to exit.</p>

## Note

The notes can be read and viewed during radiometric image analyzing in HIKMICRO Analyzer.

- Scheduled Capture: A counter is displayed in top of the screen showing the completed amount of capturing and capture interval count down.
2. Optional: You can set more capture settings as demanded.

**Table 6-2 More Optional Capture Settings**

Objective	Settings
<p>Save an additional visual image together with the thermal image.</p>	<p>Go to <b>Settings &gt; Capture Settings</b>. Enable <b>Save Visual Image</b> and set <b>Visual Image Resolution</b>.</p>

Objective	Settings
	<p> <b>Note</b></p> <p>If the targets are in poor light condition, enable <b>Flashlight</b>. The device turns on the flashlight when capturing images.</p>
Set the naming rule for images.	See <b><i>Set File Naming Rule</i></b> for reference.
View clear thermal image on high resolution screen.	<p>Go to <b>Settings &gt; Capture Settings</b>.</p> <p>Enable <b>SuperIR</b> before capturing. Captured images after <b>SuperIR</b> is ON are clearer and with more details.</p>

### What to do next

- Go to albums to view and manage files and albums. See ***Manage Albums*** and ***Manage Files*** for operation instructions.
- To edit saved images, see ***Edit Images*** for operation instructions.
- Captured files are allowed to export to PC or mobile devices for further use. See ***Export Files to PC***.

## 6.2 Record Video

### Before You Start

A memory card should be mounted for video storage.

### Steps

1. Optional: Adjust video type and frame rate.

Table 6-3 Video Type and Frame Rate

Parameter	Description
Video Type	<p><b>Radiometric Video</b> Radiometric data is attached in videos of this format. They can only be played and further analyzed with HIKMICRO Analyzer.</p> <hr/> <p> <b>Note</b> When the storage space is smaller than 500 MB, radiometric video recording is not allowed. Accidentally stopped recordings are not saved.</p> <hr/>
MP4	Recorded videos are saved in .mp4 format. These video clips can be played on local device, and any player that support this format. HIKMICRO Analyzer does not support playing this video format.
Frame Rate	Higher frame rate offers a smoother video with more details for watching especially when motion occurs. But higher frame rate also means bigger video size which consumes more storage space.

- 1) Press , and go to **Settings > Capture Settings > Frame Rate Configuration** to enable frame rate configuration.
- 2) Go to **Settings > Capture Settings > Video Type** to set saving video format and the **Frame Rate**.

 **Note**



- Frame rate configuration is not supported by certain models, see your actual product for reference.
- The frame rate is adjustable only when **Frame Rate Configuration** is enabled.
- When **Frame Rate Configuration** is enabled, the camera's visual channel is turned off. Therefore, you cannot change display mode or save the corresponding visual image during capture.
- Video type configuration is supported by certain models of this series. MP4 video type is adopted for the models of no such configuration option.

- 3) Press  to return to live view interface.
2. In the live view interface, hold the trigger to start recording.

The recording signs for radiometric video and MP4 videos are different. When you see  00:00:28, it is recording a MP4 video. When you see **hrvin** in live view, it is recording a radiometric video.

3. Pull the trigger again to stop recording. The video will be saved automatically and exit.

## Note

You can also press  or  to stop recording.

---

### What to do next

Check the saved videos from  in menu mode. See [View and Manage Local Files](#) for more information.

## 6.3 Set File Naming Rule

File naming rule for captured images and videos are user adjustable. The configurable parts are filename header and main naming rule.

File Name = Filename Header + Main Part + Format Suffix

- Filename header is adjustable from **Settings > Capture Settings > Filename Header**.
- Main part name rule is adjustable from **Settings > Capture Settings > Naming Rule**. **Time Stamp** and **Numbering** are available.

### Time Stamp

The saving time of captured file. Saving time is the device system time when the saving occurs.

### Numbering

Main part is a sequence number from 00001 to 99999.

---

## Note



- When using **Numbering**, the latest file cannot be saved when the sequence number is up to 99999. Remove the latest files in the album or change file naming to save new files.
  - The number is restored to 00001 after memory format.
- 

Format suffix is determined by the file type, see [Manage Files](#) for reference.

## 6.4 View and Manage Local Files

Device captured images and videos are saved in local albums. You can create, delete, rename and set an album as the default saving album. For files, operations, such as browsing, moving and deleting, are available.

### Steps

1. Enter albums. In live view, press  to call the main menu, and select  to enter albums.

2. To create, rename, delete and set an album as the default saving album, see ***Manage Albums*** for instructions.
3. For file operations, such as, moving or deleting a file, see ***Manage Files*** for instructions.
4. To modify an image, for example, editing the text or voice notes saved with the images, and changing the thermal parameters, see ***Edit Images*** for instructions.

---

### Note

Image editing function varies within the series. See your actual device for available operation options.







---

5. Press  to exit.

## 6.4.1 Manage Albums

You can create several albums to manage captured images and video files on your device. Newly captured images and videos are saved in the **Default Saving Album** .



### Steps





1. Enter albums. In live view, press  to call the main menu, and select  to enter albums.
2. Create an album.
  - 1) Tap  in upper right corner to add an album.
  - 2) Edit the album name.
  - 3) Press  to save the album.
3. Rename, delete or set an album as the default saving album.
  - 1) Select an album and press .
  - 2) Tap  in upper right corner of the screen.
  - 3) Select **Set as Default Saving Album**, **Rename** or **Delete** as required.  
The album icon turns to  when it is set as the default saving album.

## 6.4.2 Manage Files

Several formats of image video files are supported by the device. For certain format file, you can edit the attached notes and modify thermal parameters on device. For all files, you can check their basic information, delete or move them among albums.

### Steps







1. Enter albums. In live view, press  to call the main menu, and select  to enter albums.
2. Select an album and press .
3. Browse the image and video files.

- 1) Select a file and press .
- 2) Press  and  to browse the previous or the next file.
- 3) Press  to call the operation menu to check more available operations. File formats and their supported operations are shown below.

**Table 6-4 File Formats and Operations**

File Type	Format	Descriptions
Radiometric Images	File Name.jpeg	Editing text and voice notes, moving files, checking basic information, modifying thermal parameters, and deleting files are supported on device. See <a href="#">6.4.3 Edit Images</a> for instructions.
MP4 Videos	File Name.mp4	Playing, moving and deleting video files are supported on device.
Radiometric Video	File name.hrv	File of this format can not be played on your device. The file extension is determined by the frame rate of a video. Use HIKMICRO Analyzer to play and analyze the file. Please upgrade the software to the latest version, otherwise the .hrv file may not be supported.

#### 4. Moving or deleting several files.

- 1) In an album, tap  in the upper right corner of the screen.
- 2) Press  and  to select a file and press . If you want to select all files, tap  in the upper right corner. If you want to cancel all selection, tap .  
A selected file displays with a  in its upper right corner.
- 3) Tap **Delete** or **Move**.
  - If you tap delete, files are deleted after confirmation.
  - If you tap move, select a target album to start moving.

## 6.4.3 Edit Images

Editing the text or voice notes saved with the images, and changing the thermal parameters are allowed on your thermal camera.





---

### Note

Image editing function varies within the series. See your actual device for available operation options.

---

## Steps









1. In live view, press  to call the main menu, and select  to enter albums.
2. Select an album and press 
3. Select an image file and press  to call the editing menu.



**Figure 6-2 Editing Image**

4. Select an option and complete corresponding operations.

**Table 6-5 Editing and Managing Images**

No.	Description
1	Editing text note. Add a new text note or change the existed note, and press  to save the settings.
2	Editing voice note. You can add a new voice note, play or delete an existed voice note. <ul style="list-style-type: none"> <li>• If the file already has a voice note, tap to play or delete the note.</li> <li>• If the file has no voice note attached, press  or tap .</li> </ul>
3	Editing QR code note. Add a new Asset ID or change the existed Asset ID, and press  to save the settings.
4	Editing visual picture note. <ul style="list-style-type: none"> <li>• Press  or  to switch existed visual pictures.</li> <li>• Select  to delete unwanted pictures.</li> <li>• If there are no saved images, it enters visual camera.</li> </ul> <p>For the way of taking and saving visual pictures, refer to the related steps in <i>Capture Images</i>.</p>
5	Editing tag note. <ul style="list-style-type: none"> <li>• When browsing existed tags, press navigation buttons to switch tags and adjust tag options. Press  to save the change.</li> <li>• If you need to add tag note to the picture, make sure there is at least one tag note template saved in your device. See <i>Import and Manage Tag Note Templates</i> for importing and managing note templates.</li> </ul>

No.	Description
	For the way of adding tag notes, refer to the related steps in <u><a href="#">Capture Images</a></u> .
6	Show basic information of the file, for example, the saving time, the last modification time and resolution of the file.
7	<p>Editing thermal parameters of the image.</p> <ol style="list-style-type: none"> <li>1. Press  or tap on the  to call the main menu.</li> <li>2. Modify the image display mode, measurement parameters and tools, palettes, and level &amp; span modes. For detailed operation instructions, see <u><a href="#">Set Display Mode</a></u>, <u><a href="#">Temperature Measurement</a></u>, <u><a href="#">Switch and Manage Palettes</a></u>, and <u><a href="#">Adjust Display Temperature Range</a></u>.</li> <li>3. <b>Optional:</b> If you need a PDF report of the file, tap  on the upper right corner of the screen. Input <b>Report Name</b> and <b>Thermographer</b>, and tap  to generate a report.</li> </ol> <hr/> <p> <b>Note</b></p> <p>Generated reports are saved under the same path of the memory card as the image files. The PDF reports can not be viewed on local device. Export and read reports on computers. See <u><a href="#">Export Files to PC</a></u> for instructions.</p> <hr/> <ol style="list-style-type: none"> <li>4. When finishing all operations, tap  to save the change and exit the editing interface.</li> </ol>
8	Delete, move or transmit the file.

**Note**

The notes can be read and viewed during thermal image analyzing in HIKMICRO Analyzer.

## 6.4.4 Import and Manage Tag Note Templates

Tag note templates contains the predefined tag name and options. With the template imported and activated, users can quick add tags to captured images.

### Before You Start

Tag note templates are generated on the client software HIKMICRO Analyzer. Copy the templates of json format to the storage of your device, then you can use and manage the



templates.

Visit our website [www.hikmicrotech.com](http://www.hikmicrotech.com) to download the software HIKMICRO Analyzer.

### Steps

1. Generate tag note templates on HIKMICRO Analyzer. Get the operation instructions from the **Help** at the upper right corner of the software window.  
The generated template files are saved in PC directory: Public\HIKMICRO Analyzer\TextRemarkTemplate.
2. Connect your device to PC by the supplied cable. Copy and paste the template files to the TextNote folder of the device storage.

---

### Note

If more than one templates are imported, the first template is the active one by default. Up to 10 templates can be imported.

---

3. Go to **Settings > Capture Settings > Tag Note Template** manage templates.
  - 1) Select a template.
  - 2) Tap on  at the upper right corner of screen.
  - 3) Set the template as the default template or delete the template.

## 6.5 Export Files

Device files, such as captures, logs, can be exported to PC via supplied USB cable under USB Drive mode. Certain images and videos are able to be exported to mobile devices via mobile APP. Also, images can be exported to mobile phones with Android system via Bluetooth.

### 6.5.1 Export Files to PC

Connect the device to your PC with supplied cable, you can export the recorded videos, captured snapshots, etc.

#### Steps

1. Open the cover of cable interface.
2. Connect the device to your PC with supplied cable.
3. On pop-up window of your device, set **USB Mode** to *USB Drive*.
4. Open the detected disk on you PC, and select and copy files to PC.
5. Disconnect the device from your PC.

### Note

For the first time connection, the driver will be installed automatically.

---

### What to do next

You can import the captured snapshots to HIKMICRO Analyzer for further data analysis. See the *User Manual of HIKMICRO Analyzer* for the operation guide.

## 6.5.2 Export Files to Mobile Devices

Connect your device to a mobile device via mobile APP. Use the APP the view, download, and share on-device files.

### Before You Start

Download and install HIKMICRO Viewer to your mobile device. See [\*Thermal View Mobile Client Connection\*](#) for more information.

### Steps

1. Connect your device to mobile APP. See [\*Thermal View Mobile Client Connection\*](#) for instructions.
  2. In APP, select **On-Device Files** to enter device local albums.
- 

### Note

Radiometric videos are not available to view in APP.

---

3. Tap on a picture or video. Tap **Download** to save it to the APP **Album**.

### Result

Go to **Album** of the APP, you can see the saved pictures and videos.

### What to do next

- Share the pictures and videos to a third-part APP: In APP, select a file in **Album** and tap **Share**.
- Save the exported files to Phone album: In APP, go to **Settings > General > Save Pictures to Phone**.

## 6.5.3 Export Files via Bluetooth





Pair the device Bluetooth with the phone Bluetooth, and export images in the device Albums to the local album of your phone. Computer Bluetooth or Bluetooth of the mobile

phone with iOS system is not supported to export images.

## Before You Start

Make sure the connection between the device Bluetooth and the phone Bluetooth is successful. See ***Pair Bluetooth Devices*** for instructions.

## Steps

1. Send one image in the device **Albums** to the phone.
    - 1) Enter to the device **Albums**, and select an image.
    - 2) Press  or tap any part of the screen to call the editing menu.
    - 3) Tap  >  to select a Bluetooth device.
    - 4) Choose the paired phone Bluetooth in the available Bluetooth list.
    - 5) Press  to confirm.
- 



### Note

Videos are NOT supported to be exported via Bluetooth.

---

## 2. Optional:

Send several images in the device **Albums** to the phone.

- 1) Enter to the device **Albums**, and tap  to select no more than 16 images.
  - 2) Tap  to select a Bluetooth device.
  - 3) Choose the paired phone Bluetooth in the available Bluetooth list.
  - 4) Press  to confirm.
- 

### Note

Tap  to refresh the available devices.

---

## Chapter 7 Thermal View Mobile Client Connection

The device supports both WLAN (Wi-Fi) and hotspot function for wireless connection. Connect the device to the mobile APP, and you can control the device by mobile device.

### 7.1 Connect APP via Device WLAN

#### Before You Start

Download and install HIKMICRO Viewer on your phone.

#### Steps

1. Connect your device to a WLAN network (Wi-Fi). See [\*Connect Device to Wi-Fi\*](#) for instructions.
2. Connect APP via QR code scanning.
  - 1) Tap the  to show the complete QR code of the connected Wi-Fi network.
  - 2) Launch the app, tap + at the upper right corner of the screen and select **Scan QR Code**.
  - 3) Scan the QR code on your device screen.
  - 4) After you agree to join the WLAN network, the connection completes.  
Your device is displayed in your APP.
3. If your mobile device does not have a camera or QR code scanning fails, connect APP in this way.
  - 1) Enable the WLAN on your mobile device, and connect to the WLAN network that your device in.
  - 2) Launch the app, tap + at the upper right corner of the screen and select **Add Device**.
  - 3) Select **Handheld Device** and wait.
  - 4) After the device is displayed in APP, tap **Connect**.  
Your device is displayed in your APP.

#### Result

You can view the live view, capture snapshots, and record videos via the APP.

### 7.2 Connect APP via Device Hotspot

#### Before You Start

Download and install HIKMICRO Viewer on your phone.

### Steps

1. Turn on the device hot spot and complete hotspot settings. See ***Set Device Hotspot*** for instructions.
2. Connect APP via QR code scanning.
  - 1) Launch the app, tap **+** at the upper right corner of the screen and select **Scan QR Code**.
  - 2) Scan the QR code in the Hotspot setting interface on your device screen.
  - 3) After you agree to join the WLAN network on your phone, the connection completes. Your device is displayed in your APP.
3. If your mobile device does not have a camera or QR code scanning fails, connect APP in this way.
  - 1) Enable the WLAN on your mobile device, and find the device hotspot.

---

### Note

The device hotspot name is the serial number, which you can also find on the hotspot setting interface on your device.

---



- 2) Select the device hotspot and input its password to join.
- 3) Launch the app, tap **+** at the upper right corner of the screen and select **Add Device**.
- 4) Select **Handheld Device** and wait.
- 5) After the device is displayed in APP, tap **Connect**.  
Your device is displayed in your APP.

### Result

You can view the live view, capture snapshots, and record videos via the APP.

## Chapter 8 Connect Device to Wi-Fi

### Steps

1. Enter Wi-Fi setting interface. Choose from the following ways.
  - Tap and hold  from the swipe-down menu.
  - Go to **Settings > Connections > WLAN**.
2. Tap  to enable Wi-Fi, and the searched Wi-Fi will be listed.

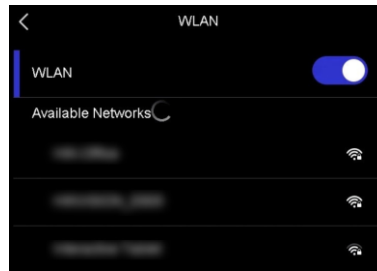



Figure 8-1 Wi-Fi List

3. Select a Wi-Fi to connect to and a soft keyboard is displayed.
4. Enter the password.
5. Tap  to hide the keypad and connect Wi-Fi.

---

### Note

- DO NOT tap **space**, or the password may be incorrect.
  - Leaving the Wi-Fi setting interface does not interrupt the connection.
- 

### Result

- A Wi-Fi icon shows on the main interface when the connection is completed. In WLAN setting interface,  displays in the connected Wi-Fi network. Tap the icon to show the full QR code. The QR code contains the information of the connected network for connecting via scanning.



### What to do next

You can tap  to turn off/on Wi-Fi connection from the swipe-down menu.

## Chapter 9 Set Device Hotspot

With the device hotspot, other equipment with WLAN (Wi-Fi) function can join the device for data transmission.

### Steps

1. Enter hotspot configuration interface. Choose from the following ways.
  - Tap and hold  from swipe-down.
  - Go to **Settings > Connections > Hotspot**.
2. Tap  to enable hotspot function.

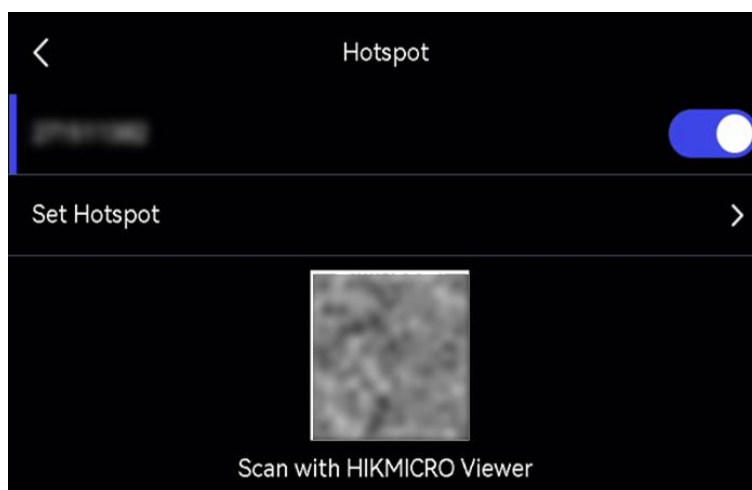

Figure 9-1 Set Hotspot

A QR code displays in the setting interface. The code is for mobile device scanning and connecting to APP.

3. Optional: Check and change hotspot password.

- 1) Select **Set Hotspot**.

It displays a randomly generated password. The password is required when other devices need to join the hotspot.

- 2) Change the password. Set your password for the hotspot by tapping the screen.

---

#### Note

- When setting a password, do not tap **space**, or the password may be incorrect.
  - The password should be at least 8 digits, consisting of numbers and characters.
  - When you restore the device, the hotspot password restores to a new random one.
- 

- 3) Press OK to save the settings.

### What to do next

You can tap  to turn off/on device hotspot from the swipe-down menu. Mobile device can join the hotspot for APP connection.





## Chapter 10 Pair Bluetooth Devices

Pair your camera with an external Bluetooth player (speaker or headsets) to play the audio recorded together with the videos and the images. Besides, pair your camera with mobile phones with Android system to export captured images to the phone.

### Before You Start

Make sure the external Bluetooth device is in discoverable mode.

### Steps

1. Enter device Bluetooth configuration page to enable the device Bluetooth. Choose from the following ways.
  - Tap and hold  from swipe-down menu.
  - Select  from the main menu. Go to **Settings > Connections > Bluetooth**.  
The device searches and displays available nearby Bluetooth devices.
2. Tap to select the desired external Bluetooth device to start automatic pairing and connecting.

### What to do next

- You can hear the audio from the captured snapshots and the recorded videos through the paired headsets.
- You can export snapshots in the device **Albums** to the phone local album.

## Chapter 11 Cast Device Screen to PC

The device supports casting screen to PC by software client HIKMICRO Analyzer. You can connect the device to your PC via a supplied USB cable, and cast the real-time live view of the device to your PC, even capture snapshots or record videos by the client.

### Before You Start

Download and install HIKMICRO Analyzer on your PC. Please visit our website [www.hikmicrotech.com](http://www.hikmicrotech.com) or contact technical support or customer service teams for installation packages.

### Steps

1. Launch HIKMICRO Analyzer, and switch to LIVE interface.

---

#### Note

Live view function is ONLY supported in HIKMICRO Analyzer v1.7.0 and the newer versions. Please download or update to v1.7.0 and the newer versions.

---

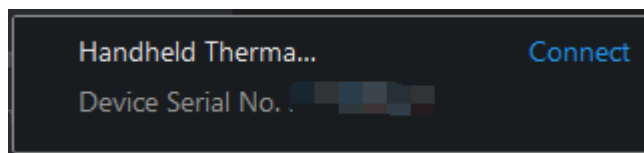

2. Use the supplied USB cable to connect your device with a PC.
3. In pop-up window of your device, select **USB Cast Screen**, and  will be displayed in the device status bar.
4. Click **Refresh** in HIKMICRO Analyzer LIVE interface, and the reminder **New Device Detected** will appear.
5. Click **Connect** in the drop-down box in HIKMICRO Analyzer LIVE interface.



The live image of your device is displayed in the PC.

## Chapter 12 Light Settings

### 12.1 Set LED Light

Press  in live view to turn on/off the LED light. Or tap  in the swipe-down menu to quickly turn on/off LED light.

### 12.2 Set Laser

In the live view interface, hold  to enable/disable the laser light.

---

#### Caution

The laser radiation emitted from the device can cause eye injuries, burning of skin or inflammable substances. Before enabling the Light Supplement function, make sure no human or inflammable substances are in front of the laser lens.

---

## Chapter 13 Maintenance

### 13.1 View Device Information

Go to **Settings > Device Settings > Device Information** to view the device information.

### 13.2 Set Date and Time

#### Steps

1. Go to **Settings > Device Settings > Time and Date**.
2. Set the date and time.
3. Press  to save and exit.

---

#### Note

Go to **Settings > Display Settings** to enable time and date on-screen display.

---

### 13.3 Upgrade Device

Device upgrade is supported by using a new firmware package or online upgrading in APP.

---

#### Note

- Make sure that the device battery is fully charged.
  - Make sure that Auto Power-off function is turned-off to avoid accidental suspension during upgrading.
  - Make sure that a memory card has been installed to device.
- 

#### 13.3.1 Upgrade Device by Upgrade File

##### Before You Start

- Please download the upgrade file from the official website <http://www.hikmicrotech.com> or contact the custom service and technical support to get the upgrade file first.
- The device is ON.

##### Steps

1. Connect the device to your PC with supplied USB cable.

2. Select **USB Mode** to **USB Drive** in device pop-up window.  
Your device is detected and displayed as a disk in your PC.
3. Unzip the file, and copy the upgrade file and paste it to the root directory of the device.
4. Disconnect the device from your PC.
5. Reboot the device and then it will upgrade automatically. The upgrading process will be displayed in the main interface.

---

### Note

After upgrading, the device reboots automatically. You can view the current version in **Settings > Device Settings > Device Information**.

---

## 13.3.2 Upgrade Device by APP

Online upgrading by mobile APP.

### Before You Start

#### Steps

1. Connect your device to APP.

See [\*Thermal View Mobile Client Connection\*](#) for APP downloading and device connecting.

2. After connecting to your device, tap **Device Upgrade** to check for the updates and proceed upgrade if a new version is available.

## 13.4 Restore Device

Go to **Settings > Device Settings > Device Initialization** to initialize the device and restore default settings.

## 13.5 Initialize Memory Card

When a memory card is use on the handheld thermal camera for the first time, it needs to be initialized first.

Go to **Settings > Device Settings > Device Initialization** to initialize the memory card.

### Caution

If there are files in the memory card, make sure that the files have been backed up before memory card initialization. Once the card is initialized, data and files can not be recovered.

---

## 13.6 Save and Export Log

Device supports saving operation logs for trouble shooting. The logs are saved in log folder under the root directory of the device storage/memory card. Connect the device to a PC to export the log files (.tar).

Go to **Settings > Device Settings > Save Log** to turn on the function.

Log saving stops when the function is turned off, or when the device shuts down or restarts.

---

### Note

Operation log files (.tar) are saved in the log folder under root directory of the device storage/memory card.

---

To export log files, refer to *[Export Files to PC](#)* for instructions.

## 13.7 About Calibration

Please contact the local dealer for the information on maintenance points. For more detailed calibration services, please refer to *<https://www.hikmicrotech.com/en/support/>*.

## Chapter 14 FAQ

Scan the following QR code to get device common FAQ.





**HIKMICRO**

See the World in a New Way