



# Handheld Thermal Camera

HIKMICRO G Series

User Manual



Contact Us

## Legal Information

©2023 Hangzhou Microimage Software Co., Ltd. All rights reserved.

### About this Manual

The Manual includes instructions for using and managing the Product. Pictures, charts, images and all other information hereinafter are for description and explanation only. The information contained in the Manual is subject to change, without notice, due to firmware updates or other reasons. Please find the latest version of this Manual at the HIKMICRO website (<http://www.hikmicrotech.com>).

Please use this Manual with the guidance and assistance of professionals trained in supporting the Product.

### Trademarks

 **HIKMICRO** and other HIKMICRO's trademarks and logos are the properties of HIKMICRO in various jurisdictions.

 **HDMI**<sup>™</sup>: The terms HDMI and HDMI High-Definition Multimedia Interface, and the HDMI Logo are trademarks or registered trademarks of HDMI Licensing Administrator, Inc. in the United States and other countries.

Other trademarks and logos mentioned are the properties of their respective owners.

### Disclaimer

TO THE MAXIMUM EXTENT PERMITTED BY APPLICABLE LAW, THIS MANUAL AND THE PRODUCT DESCRIBED, WITH ITS HARDWARE, SOFTWARE AND FIRMWARE, ARE PROVIDED "AS IS" AND "WITH ALL FAULTS AND ERRORS". HIKMICRO MAKES NO WARRANTIES, EXPRESS OR IMPLIED, INCLUDING WITHOUT LIMITATION, MERCHANTABILITY, SATISFACTORY QUALITY, OR FITNESS FOR A PARTICULAR PURPOSE. THE USE OF THE PRODUCT BY YOU IS AT YOUR OWN RISK. IN NO EVENT WILL HIKMICRO BE LIABLE TO YOU FOR ANY SPECIAL, CONSEQUENTIAL, INCIDENTAL, OR INDIRECT DAMAGES, INCLUDING, AMONG OTHERS, DAMAGES FOR LOSS OF BUSINESS PROFITS, BUSINESS INTERRUPTION, OR LOSS OF DATA, CORRUPTION OF SYSTEMS, OR LOSS OF DOCUMENTATION, WHETHER BASED ON BREACH OF CONTRACT, TORT (INCLUDING NEGLIGENCE), PRODUCT LIABILITY, OR OTHERWISE, IN CONNECTION WITH THE USE OF THE PRODUCT, EVEN IF HIKMICRO HAS BEEN ADVISED OF THE POSSIBILITY OF SUCH DAMAGES OR LOSS.

YOU ACKNOWLEDGE THAT THE NATURE OF THE INTERNET PROVIDES FOR INHERENT SECURITY RISKS, AND HIKMICRO SHALL NOT TAKE ANY RESPONSIBILITIES FOR ABNORMAL OPERATION, PRIVACY LEAKAGE OR OTHER DAMAGES RESULTING FROM

## Handheld Thermal Camera User Manual

---

CYBER-ATTACK, HACKER ATTACK, VIRUS INFECTION, OR OTHER INTERNET SECURITY RISKS; HOWEVER, HIKMICRO WILL PROVIDE TIMELY TECHNICAL SUPPORT IF REQUIRED. YOU AGREE TO USE THIS PRODUCT IN COMPLIANCE WITH ALL APPLICABLE LAWS, AND YOU ARE SOLELY RESPONSIBLE FOR ENSURING THAT YOUR USE CONFORMS TO THE APPLICABLE LAW. ESPECIALLY, YOU ARE RESPONSIBLE, FOR USING THIS PRODUCT IN A MANNER THAT DOES NOT INFRINGE ON THE RIGHTS OF THIRD PARTIES, INCLUDING WITHOUT LIMITATION, RIGHTS OF PUBLICITY, INTELLECTUAL PROPERTY RIGHTS, OR DATA PROTECTION AND OTHER PRIVACY RIGHTS. YOU SHALL NOT USE THIS PRODUCT FOR ANY PROHIBITED END-USES, INCLUDING THE DEVELOPMENT OR PRODUCTION OF WEAPONS OF MASS DESTRUCTION, THE DEVELOPMENT OR PRODUCTION OF CHEMICAL OR BIOLOGICAL WEAPONS, ANY ACTIVITIES IN THE CONTEXT RELATED TO ANY NUCLEAR EXPLOSIVE OR UNSAFE NUCLEAR FUEL-CYCLE, OR IN SUPPORT OF HUMAN RIGHTS ABUSES.

IN THE EVENT OF ANY CONFLICTS BETWEEN THIS MANUAL AND THE APPLICABLE LAW, THE LATTER PREVAILS.

## Regulatory Information

---

### Note

These clauses apply only to the products bearing the corresponding mark or information.

---

### **FCC Compliance Statement**

Please take attention that changes or modification not expressly approved by the party responsible for compliance could void the user's authority to operate the equipment. This device complies with Part 15 of the FCC Rules. Operation is subject to the following two conditions:

- (1) This device may not cause harmful interference, and
- (2) This device must accept any interference received, including interference that may cause undesired operation.

Note: Due to the device size limit, the above statement may not be disclaimed on the device. This equipment complies with FCC radiation exposure limits set forth for an uncontrolled environment.

Note: This product has been tested and found to comply with the limits for a Class B digital device, pursuant to Part 15 of the FCC Rules. These limits are designed to provide reasonable protection against harmful interference in a residential installation. This product generates, uses, and can radiate radio frequency energy and, if not installed and used in accordance with the instructions, may cause harmful interference to radio communications. However, there is no guarantee that interference will not occur in a particular installation. If this product does cause harmful interference to radio or television reception, which can be determined by turning the equipment off and on, the user is encouraged to try to correct the interference by one or more of the following measures:

- Reorient or relocate the receiving antenna.
- Increase the separation between the equipment and receiver.
- Connect the equipment into an outlet on a circuit different from that to which the receiver is connected.
- Consult the dealer or an experienced radio/TV technician for help.

### **EU Conformity Statement**



This product and - if applicable - the supplied accessories too are marked with "CE" and comply therefore with the applicable harmonized European standards listed under the EMC Directive 2014/30/EU, RE Directive 2014/53/EU, the RoHS Directive 2011/65/EU

## Handheld Thermal Camera User Manual

---

### Frequency Bands and Power (for CE)

The frequency bands and transmitting power (radiated and/or conducted) nominal limits applicable to the following radio equipment are as follows:

Equipment Model	Frequency Band and Power
G31, G41, G41H, G61, G61H*	Wi-Fi 2.4 GHz (2.4 GHz to 2.4835 GHz): 20 dBm; Bluetooth 2.4 GHz 2.4 GHz to 2.4835 GHz): 20 dBm  Wi-Fi 5 GHz (5.15 GHz to 5.25 GHz): 23 dBm; Wi-Fi 5 GHz (5.25 GHz to 5.35 GHz): 23 dBm; Wi-Fi 5 GHz (5.47 GHz to 5.725GHz): 23 dBm; Wi-Fi 5 GHz (5.725 GHz to 5.85 GHz): 14 dBm
G40, G60	Wi-Fi 2.4 GHz (2.4 GHz to 2.4835 GHz): 20 dBm; Bluetooth 2.4 GHz 2.4 GHz to 2.4835 GHz): 20 dBm

\*For G31, G41, G41H, G61, G61H, please pay attention to the following notes when the device is operating in 5 GHz:

According to Article 10 (10) of Directive 2014/53/EU, when operating in the 5150 to 5350 MHz frequency range, this device is restricted to indoor use in: Austria (AT), Belgium (BE), Bulgaria (BG), Croatia (HR), Cyprus (CY), the Czech Republic (CZ), Denmark (DK), Estonia (EE), Finland (FI), France (FR), Germany (DE), Greece (EL), Hungary (HU), Iceland (IS), Ireland (IE), Italy (IT), Latvia (LV), Liechtenstein (LI), Lithuania (LT), Luxembourg (LU), Malta (MT), Netherlands (NL), Northern Ireland (UK(NI)), Norway (NO), Poland (PL), Portugal (PT), Romania (RO), Slovakia (SK), Slovenia (SI), Spain (ES), Sweden (SE), Switzerland (CH), and Turkey (TR).

Use the power adapter provided by a qualified manufacturer. Refer to the product specification for detailed power requirements.

Use the battery provided by a qualified manufacturer. Refer to the product specification for detailed battery requirements.



2012/19/EU (WEEE directive): Products marked with this symbol cannot be disposed of as unsorted municipal waste in the European Union. For proper recycling, return this product to your local supplier upon the purchase of equivalent new equipment, or dispose of it at designated collection points.

For more information see: [www.recyclethis.info](http://www.recyclethis.info)



2006/66/EC (battery directive): This product contains a battery that cannot be disposed of as unsorted municipal waste in the European Union. See the product documentation for specific battery information. The battery is marked with this symbol, which may include lettering to indicate cadmium (Cd), lead (Pb), or mercury (Hg). For proper recycling, return the battery to your supplier or to a designated collection point. For more information see: [www.recyclethis.info](http://www.recyclethis.info)

### **Industry Canada ICES-003 Compliance**

This device meets the CAN ICES-003(B)/NMB-003(B) standards requirements.

This device complies with Industry Canada licence-exempt RSS standard(s). Operation is subject to the following two conditions:

- (1) this device may not cause interference, and
- (2) this device must accept any interference, including interference that may cause undesired operation of the device.

This equipment complies with IC RSS-102 radiation exposure limits set forth for an uncontrolled environment.

\*For G31, G41, G41H, G61, G61H, please pay attention to the following notes when the device is operating in 5 GHz:

- (i) The device for operation in the band 5150-5250 MHz is only for indoor use to reduce the potential for harmful interference to co-channel mobile satellite systems;
- (ii) The maximum antenna gain permitted for devices in the bands 5250-5350 MHz and 5470-5725 MHz shall comply with the e.i.r.p. limit; and
- (iii) The maximum antenna gain permitted for devices in the band 5725-5825 MHz shall comply with the e.i.r.p. limits specified for point-to-point and non point-to-point operation as appropriate.

### **Conformité Industrie Canada ICES-003**

Cet appareil répond aux exigences des normes CAN ICES-003 (B)/NMB-003 (B).

Le présent appareil est conforme aux CNR d'Industrie Canada applicables aux appareils radioexempts de licence. L'exploitation est autorisée aux deux conditions suivantes :

- (1) l'appareil ne doit pas produire de brouillage, et
- (2) l'utilisateur de l'appareil doit accepter tout brouillage radioélectrique subi, même si le brouillage est susceptible d'en compromettre le fonctionnement.

ce matériel est conforme aux limites de dose d'exposition aux rayonnements, CNR-102 énoncée dans un autre environnement.

Pour les modèles G31, G41, G41H, G61, et G61H veuillez prêter attention aux remarques suivantes lorsque l'appareil fonctionne en 5 GHz :

(i) Les dispositifs fonctionnant dans la bande 5150-5250 MHz sont réservés uniquement pour une utilisation à l'intérieur afin de réduire les risques de brouillage préjudiciable aux systèmes de satellites mobiles utilisant les mêmes canaux.

(ii) Le gain d'antenne maximal autorisé pour les appareils dans les bandes 5250-5350 MHz et 5470-5725 MHz doivent respecter le pire limiter; et

(iii) Le gain d'antenne maximal autorisé pour les appareils dans la bande 5725-5825 MHz doivent respecter le pire limites spécifiées pour le point-à-point et l'exploitation non point à point, le cas échéant.

### KC

B급 기기: 이 기기는 가정용(B급) 전자파적합기기로서 주로 가정에서 사용하는 것을 목적으로 하며, 모든 지역에서 사용할 수 있습니다.

### NCC

取得審驗證明之低功率射頻器材，非經核准，公司、商號或使用者均不得擅自變更頻率、加大功率或變更原設計之特性及功能。



低功率射頻器材之使用不得影響飛航安全及干擾合法通信；經發現有干擾現象時，應立即停用，並改善至無干擾時方得繼續使用。

前述合法通信，指依電信管理法規定作業之無線電通信。

低功率射頻器材須忍受合法通信或工業、科學及醫療用電波輻射性電機設備之干擾。應避克影響附近雷達系統之操作。

## Symbol Conventions

The symbols that may be found in this document are defined as follows.

Symbol	Description
 <b>Danger</b>	Indicates a hazardous situation which, if not avoided, will or could result in death or serious injury.
 <b>Caution</b>	Indicates a potentially hazardous situation which, if not avoided, could result in equipment damage, data loss, performance degradation, or unexpected results.
 <b>Note</b>	Provides additional information to emphasize or supplement important points of the main text.



## Safety Instruction

These instructions are intended to ensure that user can use the product correctly to avoid danger or property loss.

### Laws and Regulations

- Use of the product must be in strict compliance with the local electrical safety regulations.

### Transportation

- Keep the device in original or similar packaging while transporting it.
- Keep all wrappers after unpacking them for future use. In case of any failure occurred, you need to return the device to the factory with the original wrapper. Transportation without the original wrapper may result in damage on the device and the company shall not take any responsibilities.
- DO NOT drop the product or subject it to physical shock. Keep the device away from magnetic interference.

### Power Supply

- Input voltage for device should meet the Limited Power Source (5 VDC, 940 mA) according to the IEC61010-1 standard. Please refer to technical specifications for detailed information.
- Make sure the plug is properly connected to the power socket.
- DO NOT connect multiple devices to one power adapter, to avoid over-heating or fire hazards caused by overload.

### Battery

- Improper use or replacement of the battery may result in explosion hazard. Replace with the same or equivalent type only. Dispose of used batteries in conformance with the instructions provided by the battery manufacturer.
- The built-in battery cannot be dismantled. Please contact the manufacture for repair if necessary.
- For long-term storage of the battery, make sure it is fully charged every half year to ensure the battery quality. Otherwise, damage may occur.
- DO NOT charge other battery types with the supplied charger. Confirm there is no flammable material within 2 m of the charger during charging.
- DO NOT place the battery near heating or fire source. Avoid direct sunlight.
- DO NOT swallow the battery to avoid chemical burns.
- DO NOT place the battery in the reach of children.
- When the device is powered off and the RTC battery is full, the time settings can be kept

for 15 days.

- In the first use, power on the device and charge the RTC battery with the lithium battery for more than 10 hours.
- The lithium battery voltage is 3.6 V, and the battery capacity is 6700 mAh.
- The battery is certified by UL2054.
- CAUTION: Risk of explosion if the battery is replaced by an incorrect type.

### Maintenance

- If the product does not work properly, please contact your dealer or the nearest service center. We shall not assume any responsibility for problems caused by unauthorized repair or maintenance.
- A few device components (e.g., electrolytic capacitor) require regular replacement. The average lifespan varies, so periodic checking is recommended. Contact your dealer for details.
- Wipe the device gently with a clean cloth and a small quantity of ethanol, if necessary.
- If the equipment is used in a manner not specified by the manufacturer, the protection provided by the device may be impaired.
- We recommend you send the device back for calibration once a year, and please contact the local dealer for the information on maintenance points.
- Please notice that the current limit of USB 3.0 PowerShare port may vary with the PC brand, which is likely to result in incompatibility issue. Therefore it's advised to use regular USB 3.0 or USB 2.0 port if the USB device fails to be recognized by PC via USB 3.0 PowerShare port.

### Using Environment

- DO NOT expose the device to extremely hot, cold, dusty, corrosive, saline-alkali, or damp environments. Make sure the running environment meets the requirement of the device. The operating temperature shall be -20 °C to 50 °C (-4 °F to 122 °F), and the operating humidity shall be 90% or less.
- Place the device in a dry and well-ventilated environment.
- DO NOT expose the device to high electromagnetic radiation or dusty environments.
- DO NOT aim the lens at the sun or any other bright light.
- When any laser equipment is in use, make sure that the device lens is not exposed to the laser beam, or it may burn out.
- The device is suitable for indoor and outdoor uses, but do not expose it in wet conditions.
- The level of protection is IP 54.
- The pollution degree is 2.

### Technical Support

The <https://www.hikmicrotech.com/en/contact-us/> portal will help you as a HIKMICRO

# Handheld Thermal Camera User Manual

---

customer to get the most out of your HIKMICRO products. The portal gives you access to our support team, software and documentation, service contacts, etc.

## Emergency

- If smoke, odor, or noise arises from the device, immediately turn off the power, unplug the power cable, and contact the service center.

## Laser Light Supplement Warning



Warning: The laser radiation emitted from the device can cause eye injuries, burning of skin or inflammable substances. Prevent eyes from direct laser. Before enabling the Light Supplement function, make sure no human or inflammable substances are in front of the laser lens. The wave length is 650 nm, and the power is less than 1 mW. The laser meets the IEC60825-1:2014 standard.

Laser maintenance: It is not necessary to maintain the laser regularly. If the laser does not work, the laser assembly needs to be replaced in the factory under warranty. Keep the device power off when replacing laser assembly. Caution-Use of controls or adjustments or performance of procedures other than those specified herein may result in hazardous radiation exposure.

## Manufacture Address

Room 313, Unit B, Building 2, 399 Danfeng Road, Xixing Subdistrict, Binjiang District, Hangzhou, Zhejiang 310052, China  
Hangzhou Microimage Software Co., Ltd

COMPLIANCE NOTICE: The thermal series products might be subject to export controls in various countries or regions, including without limitation, the United States, European Union, United Kingdom and/or other member countries of the Wassenaar Arrangement. Please consult your professional legal or compliance expert or local government authorities for any necessary export license requirements if you intend to transfer, export, re-export the thermal series products between different countries.

# Contents

<b>Chapter 1 Overview</b> .....	<b>1</b>
<b>1.1 Device Description</b> .....	<b>1</b>
<b>1.2 Main Function</b> .....	<b>1</b>
<b>1.3 Appearance</b> .....	<b>3</b>
<b>Chapter 2 Preparation</b> .....	<b>6</b>
<b>2.1 Charge Device</b> .....	<b>6</b>
<b>2.1.1 Charge Device via Cable Interface</b> .....	<b>6</b>
<b>2.1.2 Charge Device via Charging Base</b> .....	<b>6</b>
<b>2.2 Mount Hand Strap</b> .....	<b>7</b>
<b>2.3 Mount Protective Cover</b> .....	<b>9</b>
<b>2.4 (Optional) Mount Interchangeable Lens</b> .....	<b>9</b>
<b>2.4.1 Calibrate Interchangeable Lens</b> .....	<b>11</b>
<b>2.5 Power On/Off</b> .....	<b>13</b>
<b>2.5.1 Set Auto Power-off Duration</b> .....	<b>13</b>
<b>2.6 Sleep and Wake</b> .....	<b>13</b>
<b>2.7 Operation Method</b> .....	<b>14</b>
<b>2.8 Menu Description</b> .....	<b>15</b>
<b>Chapter 3 Display Settings</b> .....	<b>19</b>
<b>3.1 Focus</b> .....	<b>19</b>
<b>3.1.1 Focus Lens</b> .....	<b>19</b>
<b>3.1.2 Laser Assisted Focus</b> .....	<b>20</b>
<b>3.1.3 Auto Focus</b> .....	<b>20</b>
<b>3.1.4 Continuous Autofocus</b> .....	<b>21</b>
<b>3.2 Set Screen Brightness</b> .....	<b>22</b>
<b>3.3 Set Display Mode</b> .....	<b>22</b>
<b>3.4 Set Palettes</b> .....	<b>23</b>
<b>3.4.1 Set Alarm Mode Palettes</b> .....	<b>26</b>

3.4.2 Set Focus Mode Palettes.....	27
3.5 Adjust Display Temperature Range .....	28
3.5.1 Level Only Adjustment in Manual Mode .....	29
3.5.2 Level & Span Adjustment in Manual Mode.....	30
3.6 Adjust Digital Zoom .....	31
3.7 Display OSD Info.....	31
<b>Chapter 4 Temperature Measurement .....</b>	<b>32</b>
4.1 Set Measurement Parameters .....	32
4.1.1 Set Unit .....	33
4.1.2 Set Color Distribution.....	33
4.2 Set Image Measurement.....	34
4.3 Set Measurement Tool .....	35
4.3.1 Measure by Custom Spot .....	36
4.3.2 Measure by Line .....	37
4.3.3 Measure by Rectangle .....	38
4.3.4 Measure by Circle .....	39
4.4 Measure $\Delta T$ and $\Delta T$ Alarm .....	40
4.5 Temperature Alarm.....	42
4.5.1 Set Alarms for Exceptional Temperatures .....	42
4.6 Clear All Measurements.....	43
<b>Chapter 5 Condensation Alarm .....</b>	<b>44</b>
<b>Chapter 6 Route Inspection.....</b>	<b>45</b>
6.1 Create Inspection Route and Send Task to Device .....	45
6.2 Perform Route Inspection.....	46
6.3 Upload Inspection Result and View Report.....	49
<b>Chapter 7 Picture and Video .....</b>	<b>51</b>
7.1 Capture Picture.....	51
7.2 Record Video .....	54
7.3 View and Manage Local Files.....	55

7.3.1 Manage Albums .....	55
7.3.2 Manage Files .....	56
7.3.3 Edit Images .....	57
7.4 Export Files .....	58
Chapter 8 Calculate Area Size .....	60
Chapter 9 Distance Detection .....	61
Chapter 10 Geographic Location Display .....	62
Chapter 11 Direction Display.....	63
11.1 Calibrate Compass .....	63
11.2 Magnetic Declination Correction.....	64
Chapter 12 Thermal View Mobile Client Connection .....	65
12.1 Connect via Wi-Fi .....	65
12.2 Connect via Hotspot .....	65
Chapter 13 Connect Device to Wi-Fi .....	66
Chapter 14 Set Device Hotspot .....	67
Chapter 15 Pair Bluetooth Devices .....	69
Chapter 16 Set LED Light .....	70
Chapter 17 Cast Device Screen to PC.....	71
Chapter 18 Image Local Output .....	72
Chapter 19 Maintenance .....	73
19.1 View Device Information.....	73
19.2 Set Date and Time.....	73
19.3 Upgrade Device .....	73
19.4 Restore Device .....	74
19.5 Initialize Memory Card .....	74
19.6 About Calibration .....	74
Chapter 20 Appendix .....	75
20.1 Common Material Emissivity Reference.....	75
20.2 FAQ.....	75

# Chapter 1 Overview

## 1.1 Device Description

Handheld Thermal Camera is a device with both optical images and thermal images. It can measure temperature and distance, record videos, take snapshots, and trigger alarms. It can also connect to Wi-Fi, hotspot and Bluetooth. The built-in high-sensitivity IR detector and high-performance sensor detect the variation of temperature and measure the real-time temperature. The built-in laser module detects the target distance. The device is easy to use, and adopts ergonomic design. It is widely applied to substations, electricity prevention detection of companies, and reconnaissance survey of construction field.

## 1.2 Main Function

### Temperature Measurement

Device detects the real-time temperature, and display it on the screen.

### Distance Measurement

Device can detect the target distance with the laser light.

### Fusion

Device can display fusion of thermal view and visual view.

### Route Inspection

Device can check the temperature of points in a predefined inspection route, and upload the results to center client for analysis.

### Geographical Location and Direction Display

For some models that are equipped with satellite positioning modules and a compass, geographical location and direction display are supported.

---

#### Note

The function is supported by certain models of this series.

---

## HDMI Output

For some models that have a micro HDMI output interface, you can connect the device to a display unit to view live image.

---

### Note

The function is supported by certain models of this series.

---

## Palettes

Device supports multiple color palettes for temperature display. You can also set palettes for a specific temperature range in alarm mode palettes and focus mode palettes to make it prominent from the rest.

## Condensation Alarm

Device detects target humidity and marks the area of humidity higher than the set threshold with green.

## Client Software Connection

- Mobile Phone: Use HIKMICRO Viewer to view live image, capture snapshots, and record videos on your phone. You can also, analyze pictures offline, generate and share a report via the app. Scan the QR codes to download the App.



HIKMICRO Viewer Android



HIKMICRO Viewer iOS

- PC: Use HIKMICRO Analyzer to analyze pictures offline professionally, and generate a custom format report on your PC. Download the client software from <https://www.hikmicrotech.com/en/industrial-products/hikmicro-analyzer-software.html>.

Use HIKMICRO Inspector to create inspection routes, send route inspection task to devices, collect inspection results and generate analysis reports.

## Bluetooth

Device can be connected to headset via Bluetooth, and you can hear the voice in the recording or capture.



## 1.3 Appearance

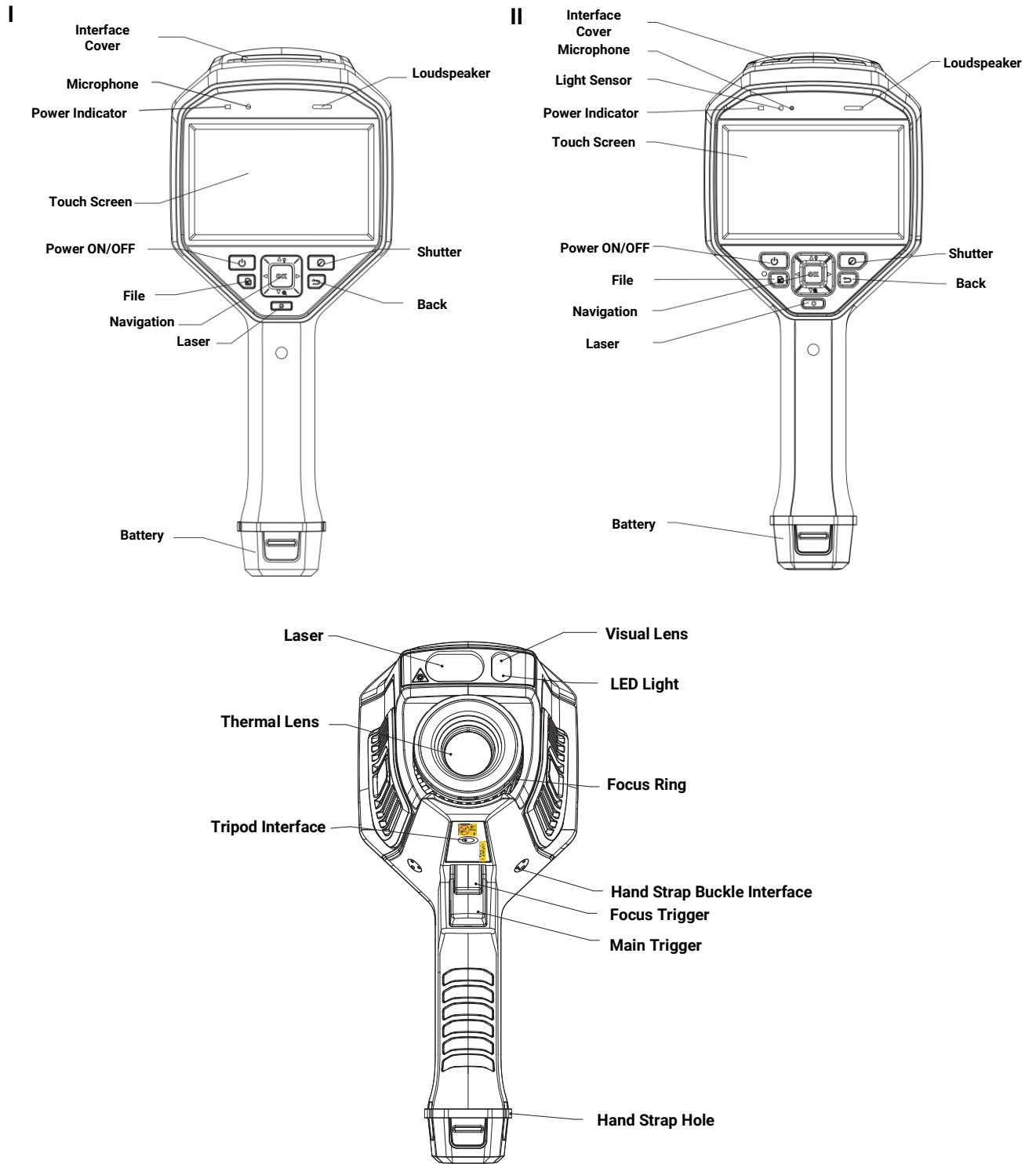

# Handheld Thermal Camera User Manual

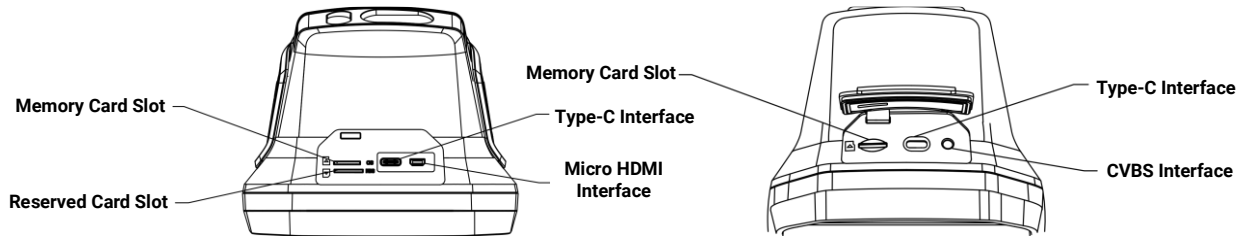

**Figure 1-1 Appearance**

**Note**

- The interface of the device may vary according to different models. Please refer to the actual product.
- The warning sign is under the laser and on the left of the device.

**Table 1-1 Interface Description**

Component	Function
Laser Button	Hold the button to turn on laser, and release the button to turn off laser.
Navigation Button	Menu Mode: <ul style="list-style-type: none"> <li>• Press <math>\Delta</math>, <math>\nabla</math>, <math>\triangleright</math>, and <math>\triangleleft</math> to select parameters.</li> <li>• Press <math>\triangleright</math> to enter the submenu.</li> <li>• Press <math>\triangleleft</math> to return to the previous menu.</li> <li>• Press <math>\text{OK}</math> to confirm.</li> </ul>
	Non-Menu Mode: <ul style="list-style-type: none"> <li>• Press <math>\Delta</math> to turn on/off the LED light.</li> <li>• Press <math>\nabla</math> to start digital zoom.</li> </ul>
Shutter Button	Press the button to perform image correction with a shutter click in the camera.
Back Button	Exit the menu or return to previous menu.
Focus Ring	Adjust the lens position at the optical axis of the thermal lens. Refer to <b><i>Focus Lens</i></b> .
Main Trigger	Pull the trigger to capture or scan the QR code. Hold the trigger to record videos.
Focus Trigger	Pull the trigger to enable laser assisted focus/auto focus function.

 **Caution**

The laser radiation emitted from the device can cause eye injuries, burning of skin or inflammable substances. Before enabling the light supplement function, make sure no human or inflammable substances are in front of the laser lens.

## Chapter 2 Preparation

### 2.1 Charge Device

---

#### **Caution**

The built-in cell battery that powers the real time clock (RTC) of the device may drain during longtime transportation or storage. It is recommended to recharge the RTC battery for the well-functioning of the device clock.

To fully charge the RTC battery, the following requirements should be met:

- The rechargeable lithium batteries should be installed on the device.
  - The device should keep working for more than 10 hours before shutting down.
- 

#### 2.1.1 Charge Device via Cable Interface

##### **Before You Start**

Please make sure the battery is installed before charging.

##### **Steps**

1. Open the top cover of the device.
2. Connect the interface and the power adaptor with Type-C or USB cable.

#### 2.1.2 Charge Device via Charging Base

##### **Steps**

---

#### **Note**

Please charge the device with the cable and power adapter supplied by the manufacturer (or according to the input voltage from the specifications).

---

1. Hold the device, and press both battery lock catches of the device.

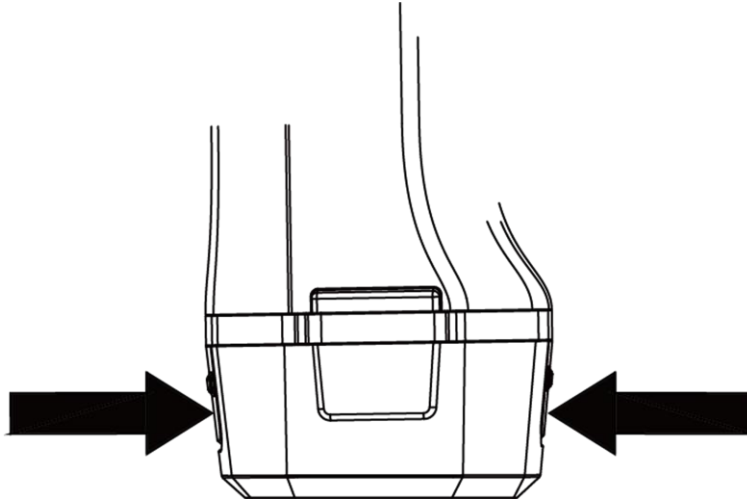

**Figure 2-1 Remove Battery Base**

2. Hold the lock catches, and draw the battery base to take out the battery.
3. Insert the battery into the charging base. You can see the charging status via the pilot lamp on the charging base.

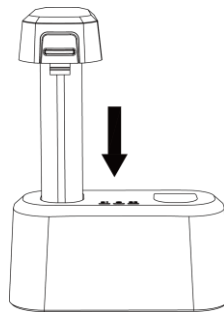

**Figure 2-2 Charge Battery**

4. When the battery is fully charged, draw the battery from the charging base.
5. Insert battery into the device.

## 2.2 Mount Hand Strap

The upper part of the hand strap is attached to the camera by a buckle. There are two buckles on both sides of the camera. The lower part of the hand strap is threaded through the hole at the base of the camera.

### Steps

1. Insert the upper part of the hand strap into the buckle.

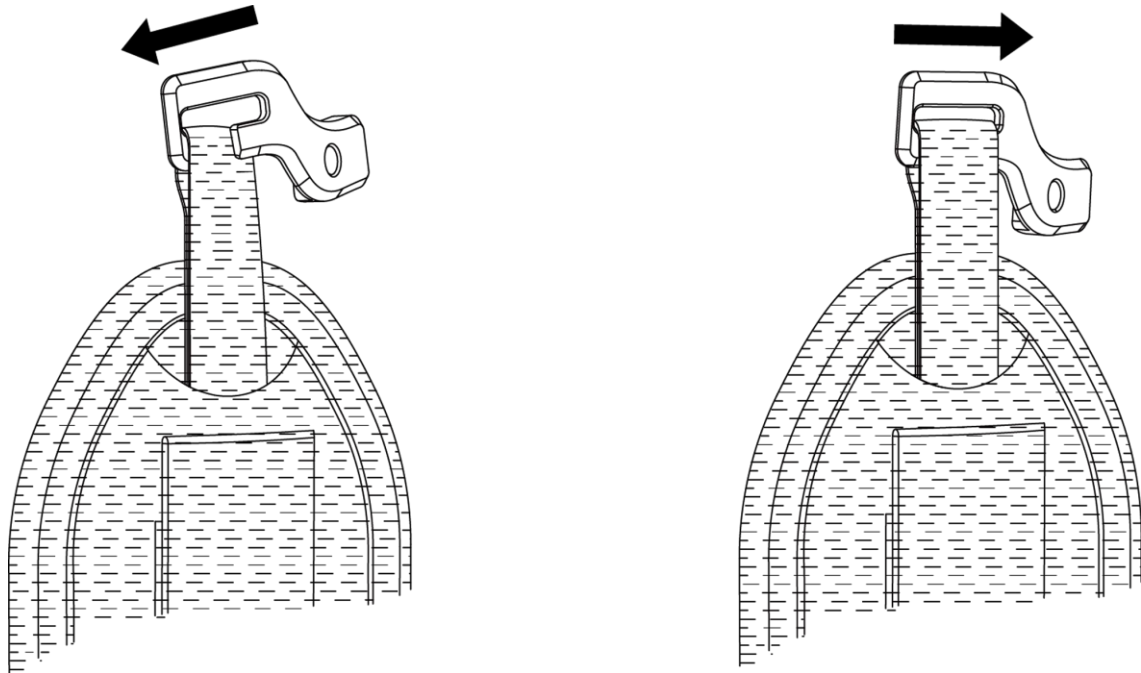

**Figure 2-3 Insert Upper Part of Hand Strap**

2. Fit the buckle on the device and tighten the screw with the supplied wrench.
3. Thread the lower part of the hand strap through the hole at the base of the device. Secure the hand strap with the hook-and-loop fastener.

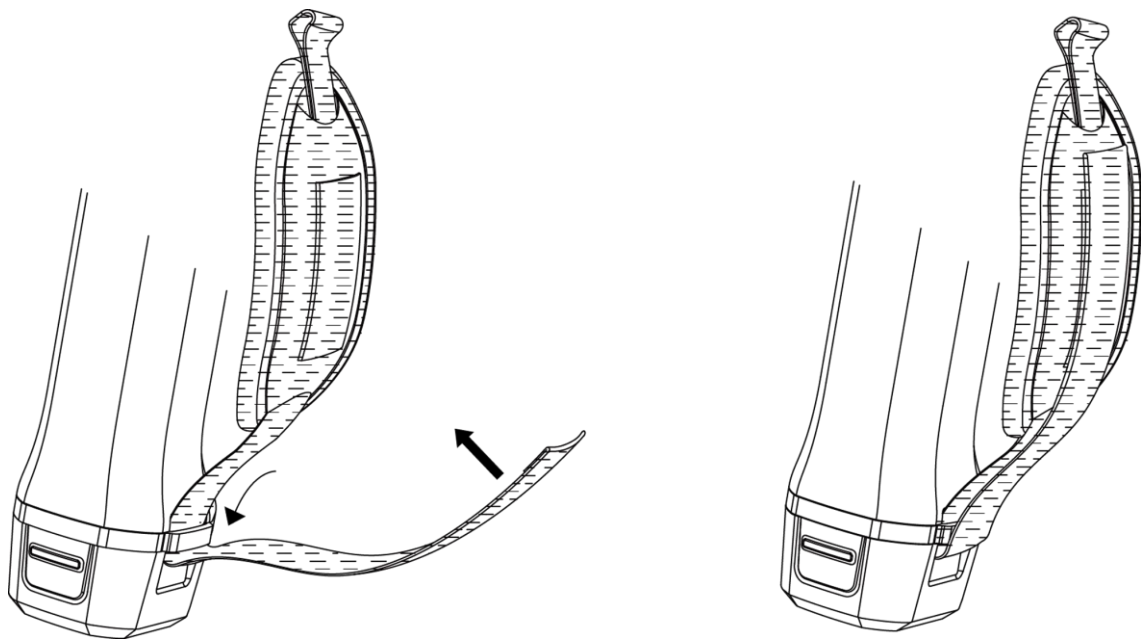

**Figure 2-4 Secure Lower Part of Hand Strap**

## 2.3 Mount Protective Cover

Attach the protective cover when the device is not in use.

### Steps

1. Align the threaded hole of the device with the mounting hole of the lens cover.
2. Insert the screw, and rotate it clockwise to fix the lens cover.

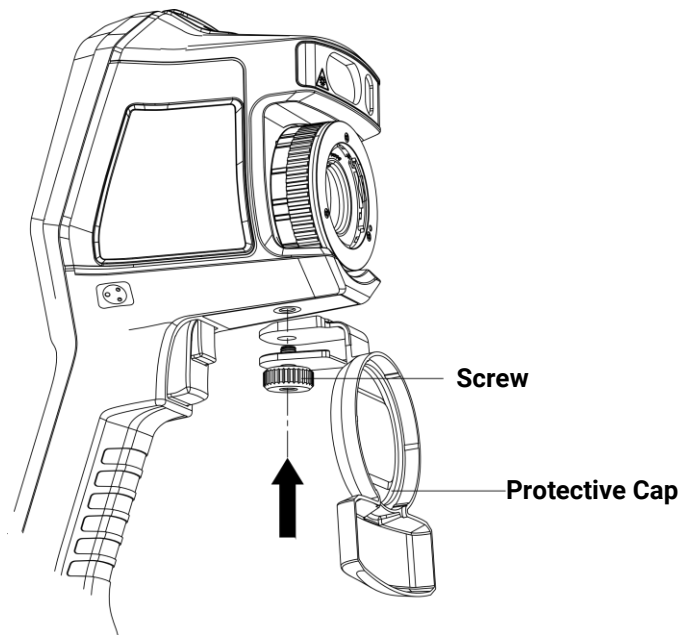

Figure 2-5 Fix Protective Cover

## 2.4 (Optional) Mount Interchangeable Lens

An interchangeable lens is an additional thermal lens that can be mounted to the device to change the original focal length to different ranges, so as to obtain different FOVs and scene scopes.

### Before You Start

- Purchase a suitable interchange lens recommended by the device manufacturer.
- The device pops up a window to show the lens information or the calibration program when detecting a mounted lens.

### Steps

1. Turn the decorative ring anticlockwise to remove it.

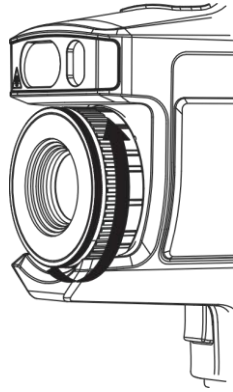

**Figure 2-6 Rotate the Decorative Ring**

2. Align the two dots on the interchangeable lens and the device.

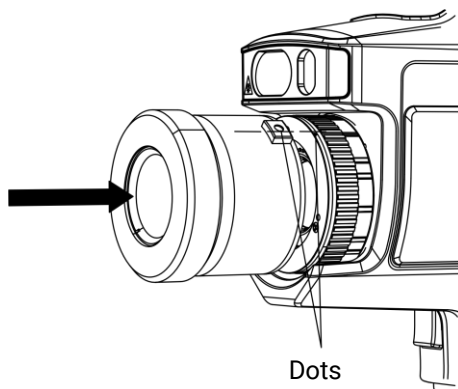

**Figure 2-7 Align the Dots**

3. Rotate the interchangeable lens clockwise to fix it.

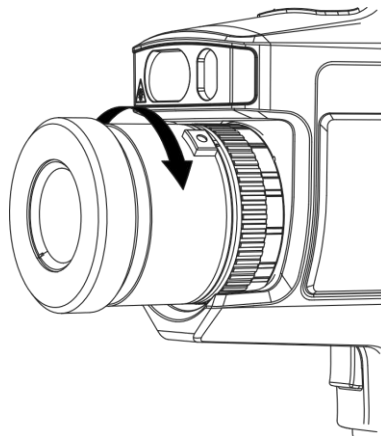

**Figure 2-8 Mount the Lens**

4. Optional: Rotate the interchangeable lens anticlockwise to dismount it.



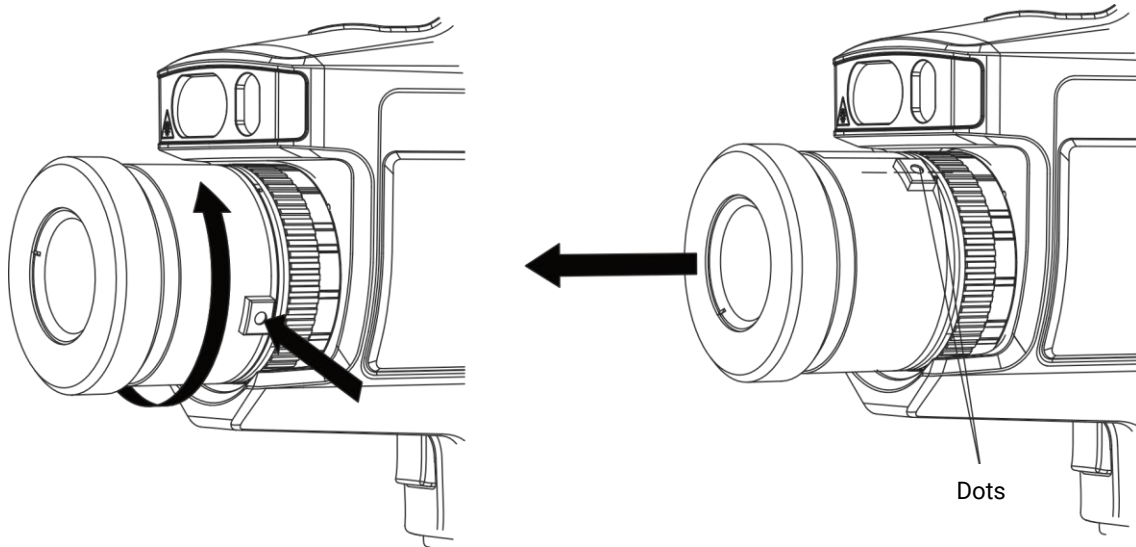

**Figure 2-9 Dismount the Lens**

---

## Note

When a new interchangeable lens is mounted on the device, it takes about 2 minutes to achieve accurate temperature measurement. Before that, ~ is added before the temperature value. ~ disappears after the device can accurately measure the temperature.

---

## What to do next

Calibrate the lens before you can use it normally. See [\*Calibrate Interchangeable Lens\*](#) for instructions.

## 2.4.1 Calibrate Interchangeable Lens

This part introduce how to calibrate a newly mounted interchangeable lens.

### Before You Start

- Avoid strong light (for example, sun light and white light source) when calibrating the lens. It is recommended to calibrate the lens indoor and with no strong light around.
- Place the target plate on a flat surface with the "TARGET" facing the lens.
- Power on the target plate to heat it (12 VDC).
- Start the calibration when the temperature of the plate rises (about 1 minute later after powering on the plate).

### Steps

1. Power on the handheld camera.
2. Follow the pop up interactive instructions to start the calibration.

### Note

The instruction window pops up immediately after mounting the lens. If you accidentally exit the calibration program, go to **Settings > Capture Settings > Calibrate for Interchangeable Lens** to enter again.

---

3. Hold the camera and aim the lens at the target plate. Adjust the distance to the target according to device prompts.

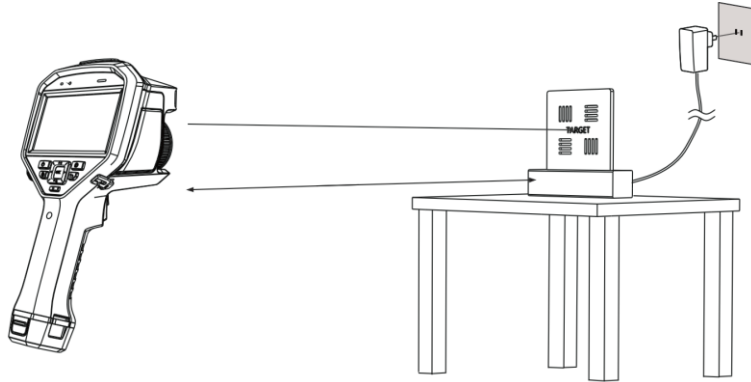

**Figure 2-10 Aim at the Target Plate**

4. Press , and the camera emits a beam of red laser.
  5. Slightly adjust the camera position to aim the red laser dot at the "TARGET" character on the plate and keep still for measuring the distance.
- 

### Note

- If the measurement succeeds, the distance is displayed on the screen. If it fails, adjust the distance and try again.
  - It is recommended to use a tripod to fix the camera if keeping it still is difficult.
- 

6. Use the left/right buttons or the focus ring to adjust the focus, and press  after the "TARGET" is clear (as shown in the following image).

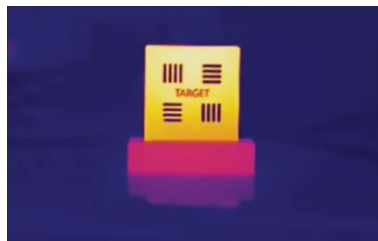

7. Adjust the target's optical image with navigation buttons until it overlaps with the thermal image, and press . The well-overlapped image is shown as follows.
-

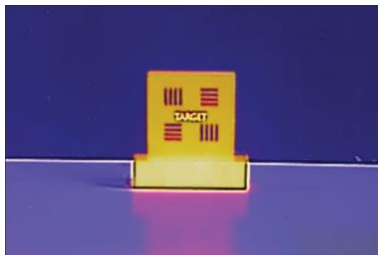

## What to do next

After the lens is calibrated, you can check the lens information at **Settings > Device Settings > Device Information** and see the lens type (0.5×, 2×, etc.) on the observation interface.

## 2.5 Power On/Off

### Power On

Remove the lens cover, and hold  for over three seconds to turn on the device. You can observe the target when the interface of the device is stable.

---

#### Note

It may take at least 30 s until the device is ready for using when you power on it.

---

### Power Off

When the device is turned on, hold  for three seconds to power off the device.

### 2.5.1 Set Auto Power-off Duration

Go to **Settings > Device Settings > Auto Off** to set the automatic shutdown time for device as required.

## 2.6 Sleep and Wake

Sleep and wake function is used to save energy and increase battery time.

### Sleep and Wake Manually

Press  to enter sleep mode and press it again to wake the device up.

### Set Auto Sleep

In live view, press  to call the main menu. Go to **Settings > Device Settings > Auto Sleep** to set waiting time before auto sleep. When there is no button pressing or screen

tapping operation on device for more than the set waiting time, device enters sleep mode automatically.

Press  to wake the device up.

## Device Sleep, Scheduled Capture and Video Recording

When the device is recording a video clip or on scheduled capturing, auto sleep will not be triggered. However, press  will stop the video recording or scheduled capture and force the device into sleep mode.

## 2.7 Operation Method

The device supports both touch-screen control and button control.

### Touch-screen control

Tap on the screen to set parameters and configurations.

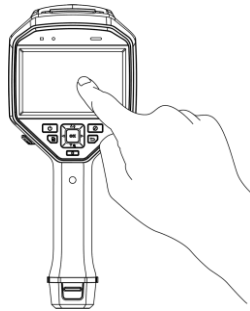

Figure 2-11 Touch-screen Control

### Button control

Press the navigation buttons to set parameters and configurations.

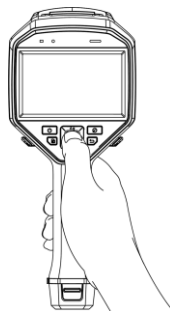









Figure 2-12 Button Control

- Press , , , and  to select parameters.
- Press  to enter the submenu.
- Press  to return to the previous menu.
- Press  to confirm.

## 2.8 Menu Description

### Live View Interface

Device screen display the live view of thermal camera after starting-up.

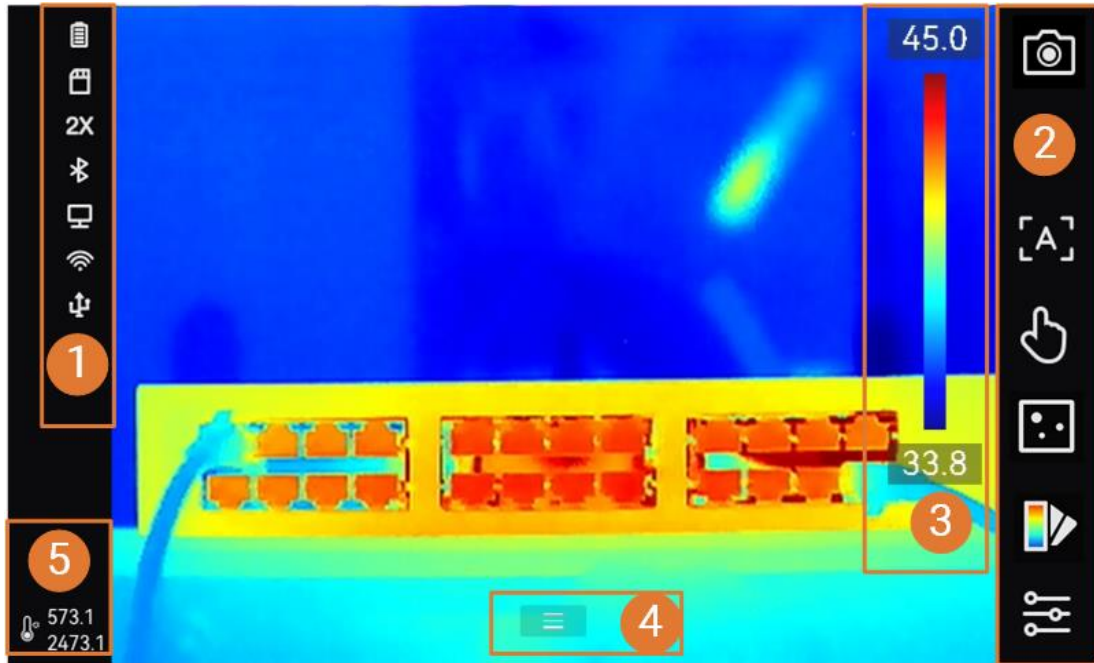



Figure 2-13 Live View









Table 2-1 Live View Interface Description

No.	Descriptions
1	Status bar, where device working status, such as, battery and connections, are displayed.
2	Shortcut bar. Focus mode, level & span mode, display mode, palettes, capturing and recording, and measurement settings support quick operation.
3	<p>Palette bar and display temperature range. The upper and lower values of the palette bar represent the max. temperature and the min. temperature of the current display temperature range.</p> <hr/> <p><b>Note</b></p> <p>If a "~" appears before a temperature value, it means that your device is not well prepared for accurate temperature measurement. Take target temperatures when the sign disappears.</p>





## Handheld Thermal Camera User Manual



No.	Descriptions
4	Main menu icon. Press  or tap  to call main menu.
5	Real-time temperature range display.

**Table 2-2 Description of Status Display**

Status Display	Description
	Battery Status
	The device is connected to PC via Type-C cable.
	Wi-Fi is connected.
	Memory Card is inserted.
	Bluetooth is on.
	Interchangeable Lens is mounted on the device and the interchangeable lens type is on the bottom right of the icon.
	The inspection data is transmitting to the device.
	Cast Screen is on.
	Compass is on. The number stands for the calibration level. Numbers smaller than 3 mean that the compass is not properly calibrated and the direction displayed might not be correct.

**Table 2-3 Description of Shortcut Function**

Icon	Description
	Tap to capture a snapshot, and hold to start recording. Tap  to stop recording.
	Tap to switch focus mode.
	Tap to switch manual and auto level & span.
	Tap to switch display mode.

Icon	Description
	Tap to switch palettes.
	Tap to set temperature measurement parameters such as humidity, emissivity, distance, and temperature.

### Main Menu

Supported operations in the main menu from left to right are settings, local file browsing and managing, display mode configuration, temperature measurement, palettes changing, and level & span.



Figure 2-14 Main Menu

### Swipe-down Menu

In live view interface, swipe on screen from upper to lower to call the swipe-down menu. With this menu, you can turn on/off device function, change display theme, and adjust screen brightness. Long tap the icon of **Wi-Fi**, **Hotspot** or **Bluetooth** to jump to its configuration interface.

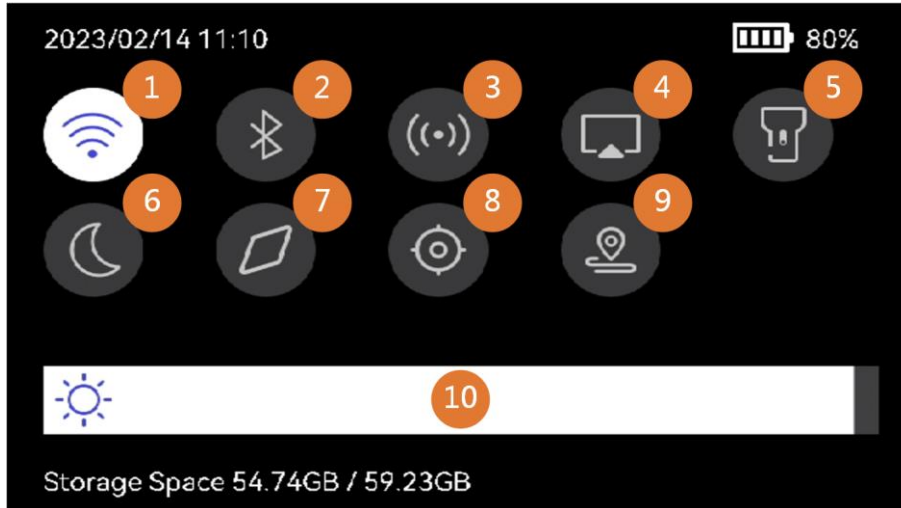



Figure 2-15 Swipe-down Menu

Table 2-4 Swipe-down Menu Description

No.	Descriptions
1	Turn on/off Wi-Fi. For Wi-Fi configuration, see <a href="#"><i><b>Connect Device to Wi-Fi</b></i></a> for instructions.

## Handheld Thermal Camera User Manual

No.	Descriptions
2	Turn on/off bluetooth. For bluetooth configuration, see <b><i><u>Pair Bluetooth Devices</u></i></b> for instructions.
3	Turn on/off hotspot. For hotspot configuration, see <b><i><u>Set Device Hotspot</u></i></b> for instructions.
4	Turn on/off USB cast screen. See <b><i><u>Cast Device Screen to PC</u></i></b> for instructions.
5	Turn on/off LED light.
6	Switch themes, day and night are supported.
7	<p>Turn on/off compass. For compass configuration and calibration, see <b><i><u>Direction Display</u></i></b> for instructions.</p> <hr/> <p> <b>Note</b> Supported by certain models.</p> <hr/>
8	<p>Turn on/off geographic location display. See <b><i><u>Geographic Location Display</u></i></b> for instructions.</p> <hr/> <p> <b>Note</b> Supported by certain models.</p> <hr/>
9	Enter/exit route inspection mode. For route instruction introduction and usage guide, see <b><i><u>Route Inspection</u></i></b> for more information.
10	Adjust screen brightness.



## Chapter 3 Display Settings

---

### Note

Your device will periodically perform a self-calibration to optimize image quality and measurement accuracy. In this process the image will pause briefly and you'll hear a "click" as a shutter moves in front of the detector. The self-calibration will be more frequent during start up or in very cold or hot environments. This is a normal part of operation to ensure optimum performance for your device.

---

### 3.1 Focus

Adjust the focusing to clearly display target objects before doing other operations, or it may affect the image display and temperature accuracy.

#### 3.1.1 Focus Lens

##### Steps

1. Power on the device.
2. Aim the device lens to the appropriate scene.
3. Adjust the focus knob clockwise or anticlockwise, see figure below.

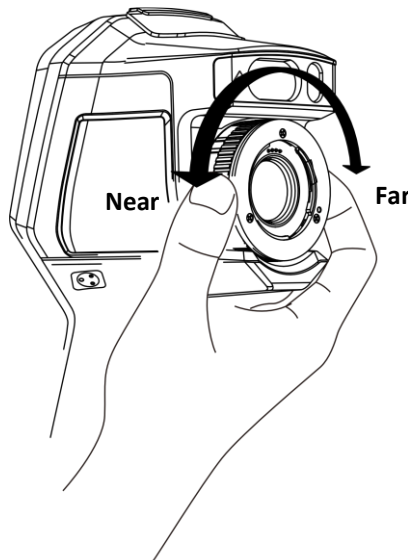

Figure 3-1 Focus Lens

## Note

DO NOT touch the lens to avoid affecting the display effect.



### 3.1.2 Laser Assisted Focus

Aim the laser at the target and the device focuses automatically.

#### Before You Start

- It is recommended to use this function in a non-glare environment, such as indoor environment.
- The target should have good light reflection, such as white paper and cable.

#### Steps

1. Enable **Laser Assisted Focus** by the following ways:
    - Select , and go to **Device Settings > Focus > Focus Mode** to enable **Laser Assisted Focus**.
    - In live view, tap the focus shortcut key in shortcut bar and switch to **Laser Assisted Focus** .
  2. In live view, aim the image center at the target and hold the **Focus Trigger**.
  3. When you see a red dot display in the image center and a laser dot at the target, release the trigger to start focusing automatically.
- 

#### Warning

The laser radiation emitted from the device can cause eye injuries, burning of skin or inflammable substances. Prevent eyes from direct laser. Before enabling the function, make sure no human or inflammable substances are in front of the laser lens.

---

4. Optional: If the focusing effect is not satisfactory, slightly adjust the focus ring for better image.

### 3.1.3 Auto Focus

The device focuses automatically in current scene by comparing the brightness, contrast, etc. In this mode, you can pull the trigger or touch the screen to focus.

You can enable **Auto Focus** by the following ways:

- Go to **Settings > Device Settings > Focus > Focus Mode** to enable **Auto Focus**.
- In live view, tap the focus shortcut key on the right and switch it to **Auto Focus** .

In live view, aim the image center at the target and pull the focus trigger once. The device adjust its focus on targets in the image center.

If you want to switch the focus to other objects, tap the desired screen area to adjust the focus.

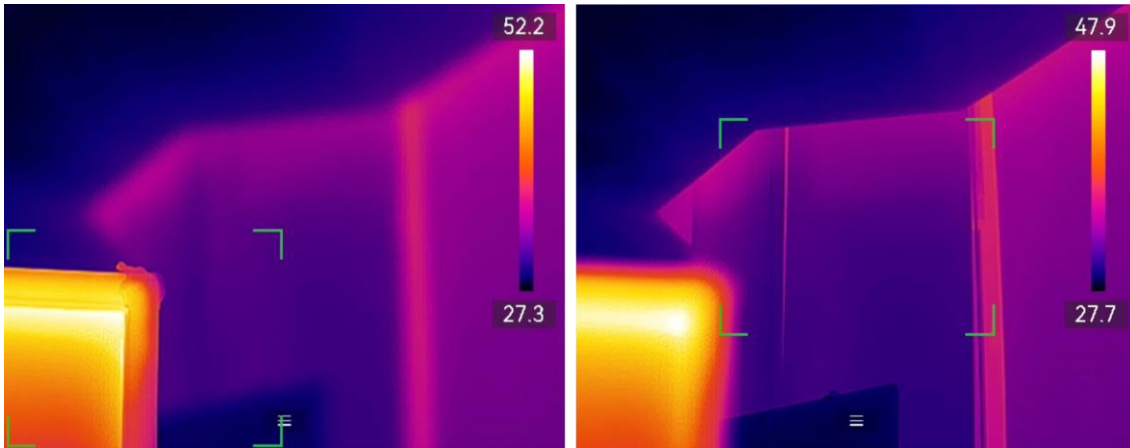

**Figure 3-2 Switching Focus**

---

**Note**

- DO NOT adjust the focus ring when the device is auto focusing, otherwise it will interrupt the auto focusing process.
  - If the target is not clearly focused in this mode, adjust the focus ring to fine-tune the image.
- 

### 3.1.4 Continuous Autofocus

In **Continuous Autofocus** mode, the device focuses on the target automatically to make the scene clear. Use this mode when the device is stationary.

---

**Caution**

Turn off **Continuous Autofocus** when the device is moving, or it may affect the device function.

---

You can enable **Continuous Autofocus** by the following ways:

- Go to **Settings > Device Settings > Focus > Focus Mode** to enable **Continuous Autofocus**.
- In live view, tap the focus shortcut key in shortcut bar and switch it to **Continuous Autofocus**.

Aim the device at the target, and the device focuses on the objects in image center automatically.

---

**Note**

Focus ring adjustment does not take effect in this mode.

---

## 3.2 Set Screen Brightness

The device supports auto or manual screen brightness adjustment.

**Table 3-1 Screen Brightness Adjustment**

Method	Operation
Manual	Go to <b>Settings &gt; Device Settings &gt; Screen Brightness</b> to adjust the screen brightness. Or tap  , and drag it to adjust the screen brightness.
Auto	Go to <b>Settings &gt; Device Settings &gt; Screen Brightness</b> to enable <b>Auto</b> . Devices adjust the screen brightness automatically when the ambient brightness changes.

### Note

The auto screen brightness adjustment function is only supported by devices with light sensors. Please take the actual device for reference.

## 3.3 Set Display Mode

You can set the thermal/optical view of the device. **Thermal, Fusion, PIP, Visual, and Blending** are selectable.

### Steps

1. Select  from the main menu.

### Note

In live view, tap the display mode shortcut key  on the right to switch display modes quickly.

2. Tap on the icons to select a display mode.



In **Thermal** mode, the device displays the thermal view.



In **Fusion** mode, the device displays the combined view of thermal channel and visual channel.



In **PIP** (Picture in Picture) mode, the device displays thermal view inside the visual view.

---

## **Note**

Select PIP, and enter PIP setting interface.

- Adjust position: Tap the PIP view, and drag it to the target position on screen.
  - Adjust size: Tap one of the PIP view corners, and drag it to adjust the size.
- 



In **Visual** mode, the device displays the visual view.



In **Blending** mode, the device displays the mixture view of thermal and visual channels. Press ◀ and ▶ to select the **Level**. The lower the level is, the denser the visual effect is.

3. Press  to exit.

## 3.4 Set Palettes

The palettes allow you to select the desired colors.

### Steps

1. Select  from the main menu.
2. Tap on the icons to select a palette type.

#### **White Hot**

The hot part is light-colored in view.



**Figure 3-2 White Hot Example**

#### **Black Hot**

The hot part is black-colored in view.

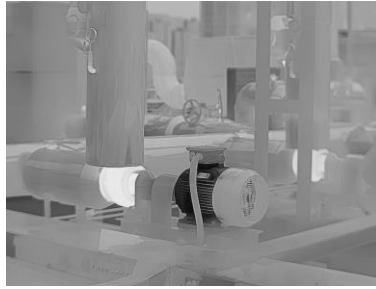

**Figure 3-3 Black Hot Example**

## **Rainbow**

The target displays multiple colors, it is suitable for scene without obvious temperature difference.

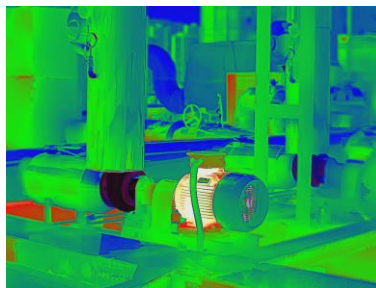

**Figure 3-4 Rainbow Example**

## **Ironbow**

The target is colored as heated iron.

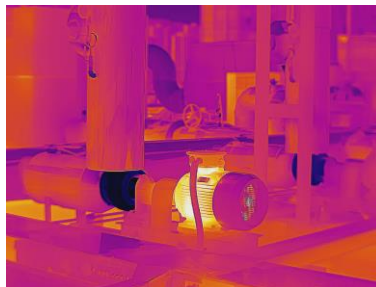

**Figure 3-5 Ironbow Example**

## **Red Hot**

The hot part is red-colored in view.



**Figure 3-6 Red Hot Example**

## **Fusion**

The hot part is yellow-colored and the cold part is purple-colored in view.

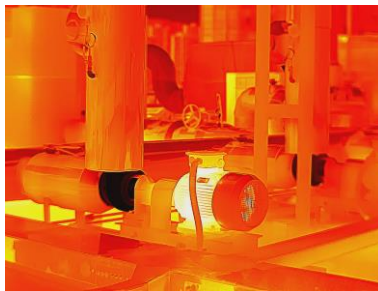

**Figure 3-7 Fusion Example**

## **Rain**

The hot part in the image is colored, and the else is blue.

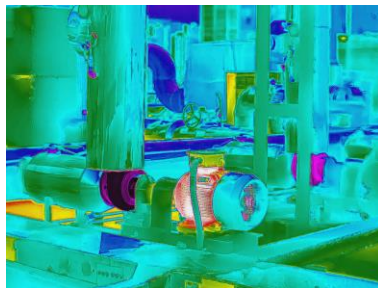

**Figure 3-8 Rain Example**

## **Blue Red**

The hot part in the image is colored red, and the else is blue.

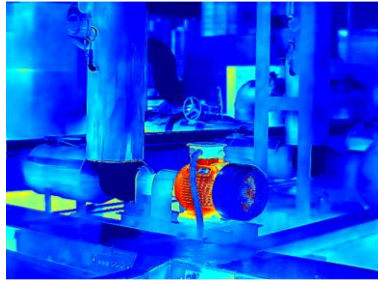



Figure 3-9 Blue Red Example

3. Press  to exit the setting interface.

 **Note**

You can also tap  in the shortcut bar in live view to change the palettes.



### 3.4.1 Set Alarm Mode Palettes

Alarm mode palettes allows to mark the targets of certain temperature range with a different color from the rest.



**Steps**

1. Select **Palettes** from the main menu.
2. Tap the icons to select an alarm rule type.

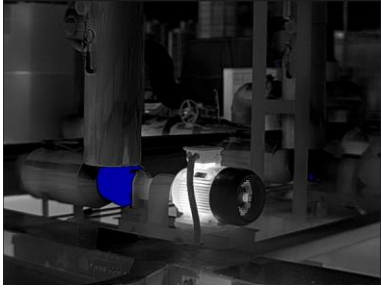
Table 3-2 Icon Description

Icon	Alarm Mode	Description	Example
	Above Alarm	Set the alarm temperature, and the targets with the temperature higher than the set value are displayed in red.	
	Below Alarm	Set the alarm temperature, and targets with the temperature lower than the set value are displayed in blue.	

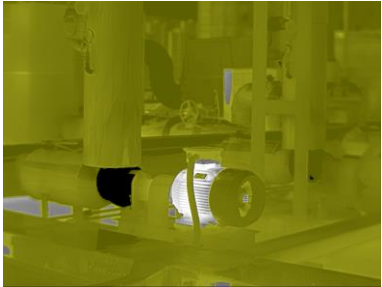

Icon	Alarm Mode	Description	Example
	Interval Alarm	Set the alarm temperature section (e.g., 90 °C to 150 °C), and targets with the temperature in the range are displayed in yellow.	
	Insulation Alarm	Set the alarm temperature section (e.g., 90 °C to 120 °C), targets with the temperature out of the section (e.g., 70 °C or 125 °C) are displayed in purple or blue.	

3. Set a temperature range.
  - Press  $\Delta$  and  $\nabla$  to select between upper limit and lower limit. Press  $\triangleleft$  and  $\triangleright$  to adjust the temperature.
  - Tap on the screen to select an interest area. The device automatically adjusts the upper and lower temperature limit of the selected scene. Press  $\triangleleft$  and  $\triangleright$  to fine-tune the temperature.
4. Press  to exit.

### 3.4.2 Set Focus Mode Palettes





Focus mode palettes allows to mark the targets of certain temperature range with fusion palettes and the others with white hot palettes.

#### Steps

1. Select **Palettes** from the main menu.
2. Tap the icons to select an alarm rule type.

**Table 3-3 Icon Description**

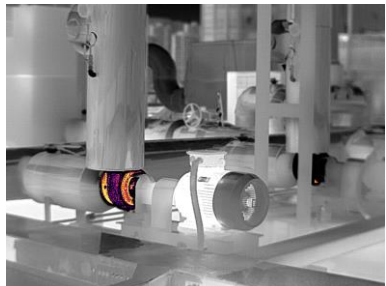
Icon	Palettes Mode	Description	Example
------	---------------	-------------	---------

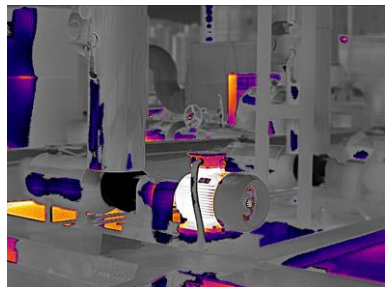
Icon	Palettes Mode	Description	Example
	Above Focus	Set the temperature threshold, and the targets with the temperature higher than the set value are displayed with fusion palettes.	
	Below Focus	Set the temperature threshold, and targets with the temperature lower than the set value are displayed with fusion palettes.	
	Interval Focus	Set the temperature range (e.g., 90 °C to 150 °C), and targets in the range are displayed with fusion palettes.	

3. Set a temperature range.

- Press  $\Delta$  and  $\nabla$  to select between upper limit and lower limit. Press  $\triangleleft$  and  $\triangleright$  to adjust the temperature.
- Tap on the screen to select an interest area. The device automatically adjusts the upper and lower temperature limit of the selected scene. Press  $\triangleleft$  and  $\triangleright$  to fine-tune the temperature.





4. Press  to exit.

### 3.5 Adjust Display Temperature Range

Set a temperature range for screen display and the palette only works for targets within the temperature range. You can adjust the temperature range.



**Steps**

1. Select an adjustment mode.

- 1) In live view, press  to call the main menu.
  - 2) Tap .
  - 3) Choose **Auto** or **Manual**.
2. Adjust the display temperature range.

**Auto Adjustment** Select . The device adjusts display temperature range according to the actual targets temperature automatically.

**Manual Adjustment** There are two modes to manually adjust display temperature range. You can go to **Settings > Measurement Settings > Manual Level and Span Mode** to choose the preferred mode. See ***Level & Span Adjustment in Manual Mode*** and ***Level & Span Adjustment in Manual Mode*** for more instructions.

3. Optional: You can change display modes or palettes by tapping  or  in the shortcut bar.

---

### Note

In Level & Span setting interface, the visual display mode cannot be switched on using the shortcut key, and the size and position of PIP view are not configurable.

---







### 3.5.1 Level Only Adjustment in Manual Mode

Manually adjust the maximum temperature and the minimum temperature respectively to expand or reduce the temperature range.

#### Before You Start

Go to **Settings > Measurement Settings > Manual Level and Span Mode** and enable **Level Only**.

#### Steps

1. In live view, press  to call the main menu.
2. Tap .
3. Tap on an interest area of the screen.  
A circle is displayed around the area, and the temperature range readjusts to show as many details of the area as possible, according to the selected area.
4. Fine-tune the temperature range for display.
  - 1) Press  or , or tap on the value on screen to lock or unlock a value.
  - 2) Press  or , or scroll the adjustment wheel on the screen to fine-tune the maximum temperature and the minimum temperature respectively.



**Figure 3-10 Level Only Adjustment**

5. Press  to confirm.



## 3.5.2 Level & Span Adjustment in Manual Mode

Increase or decrease the individual values of both the maximum temperature and the minimum temperature while remaining the same temperature range. You can also expand or reduce the temperature range evenly.

### Before You Start

Go to **Settings > Measurement Settings > Manual Level and Span Mode** and enable **Level & Span**.

### Steps

1. In live view, press  to call the main menu.
2. Tap .
3. Tap on an interest area of the screen.  
A circle is displayed around the area, and the temperature range readjusts to show as many details of the area as possible, according to the selected area.
4. Fine-tune the temperature range for display.
  - 1) Press  $\Delta$  or  $\nabla$  to increase or decrease the individual values of both maximum temperature and the minimum temperature while remaining the same temperature range.
  - 2) Press  $\triangleleft$  or  $\triangleright$  to expand or reduce the temperature range evenly.





**Figure 3-11 Level & Span Adjustment**

5. Press  to confirm.

## 3.6 Adjust Digital Zoom

In the live view interface, press  to enter the digital zoom setting interface.

- Hold  or  to zoom in or zoom out continuously.



**Figure 3-12 Adjust Zooming Ratio Continuously**

- Press  or  to fine-tune the zooming ratio.



**Figure 3-13 Fine-Tune Zooming Ratio**

- Tap the zooming ratio slider, and drag it to the left or right to adjust zooming ratio.

## 3.7 Display OSD Info

Go to **Settings > Display Settings** to enable the information on-screen display.

### Status Icon

The device status icons, for example, battery status, memory card, hotspot, etc.

### Time and Date

Device time and date.

### Parameters

Temperature measurement parameters, for example, target emissivity, temperature unit, etc.

### Distance

Laser measurement result.

### Brand Logo

The brand logo is a manufacturer logo displayed on the upper right corner of the screen. You can turn it off if not needed.

### Inspection Image

Display the inspection image.

## Chapter 4 Temperature Measurement

The thermography (temperature measurement) function provides the real-time temperature of the scene and display it on the left of your screen. The thermography function is turned on by default.

---

### Note

Your device will periodically perform a self-calibration to optimize image quality and measurement accuracy. In this process the image will pause briefly and you'll hear a "click" as a shutter moves in front of the detector. The self-calibration will be more frequent during start up or in very cold or hot environments. This is a normal part of operation to ensure optimum performance for your device.

---

### 4.1 Set Measurement Parameters

You can set measurement parameters to improve the accuracy of temperature measurement.

#### Steps

1. Go to **Settings > Measurement Settings**.
2. Set **Temperature Range, Emissivity**, etc.

#### Temperature Range

Select the temperature measurement range. The device can detect the temperature and switch temperature range automatically in **Auto Switch** mode.

---

### Note

For some models, which Aperture Diaphragm is included in the package, make sure to mount Aperture Diaphragm before switching to the 300 °C~2000 °C temperature range (only supported by certain models). Refer to ***Mount Interchangeable Lens*** for Aperture Diaphragm mounting instructions.

---

#### Emissivity

Refer to ***Common Material Emissivity Reference*** to set the emissivity of your target.

#### Reflection Temperature

If any object (not the target) of high temperature is in the scene, and the target emissivity is low, set the reflection temperature as the high temperature to correct the temperature effect.

## Distance

The distance between the target and the device. You can customize the target distance or select the target distance as **Near, Middle, or Far**.

## Humidity

Set the relative humidity of current environment.

## External Optics Transmittance

Set the optics transmittance of external optical material (e.g., germanium window) to improve the temperature measuring accuracy.

## External Optics Temperature

Set temperature of the external optical material (e.g., germanium window).

3. Return to previous menu to save the settings.



You can go to **Settings > Device Settings > Device Initialization > Remove All Measurement Tools** to initialize the temperature measurement parameters.

---

## 4.1.1 Set Unit

Go to **Settings > Device Settings > Unit** to set the temperature unit and distance unit.

## 4.1.2 Set Color Distribution

Color distribution function provides different image display effects in auto level & span. Linear and histogram color distribution modes can be selected for different application scenes.

### Before You Start

Select **Auto** in level & span.

### Steps

1. Go to **Settings > Measurement Settings > Color Distribution**.
2. Select a color distribution mode.
  - **Linear**: Linear mode is used to detect small high temperature targets in low temperature background. Linear color distribution enhances and displays more details of high temperature targets, which is good for checking small high temperature defective areas such as cable connectors.
  - **Histogram**: Histogram mode is used to detect temperature distribution in large areas. Histogram color distribution enhances high temperature targets and remains some

details of low temperature objects in the area, which is good for discovering small low temperature targets such as cracks.

3. Return to previous menu to save the settings.

 **Note**

This function is only supported in auto level & span.

**Example**

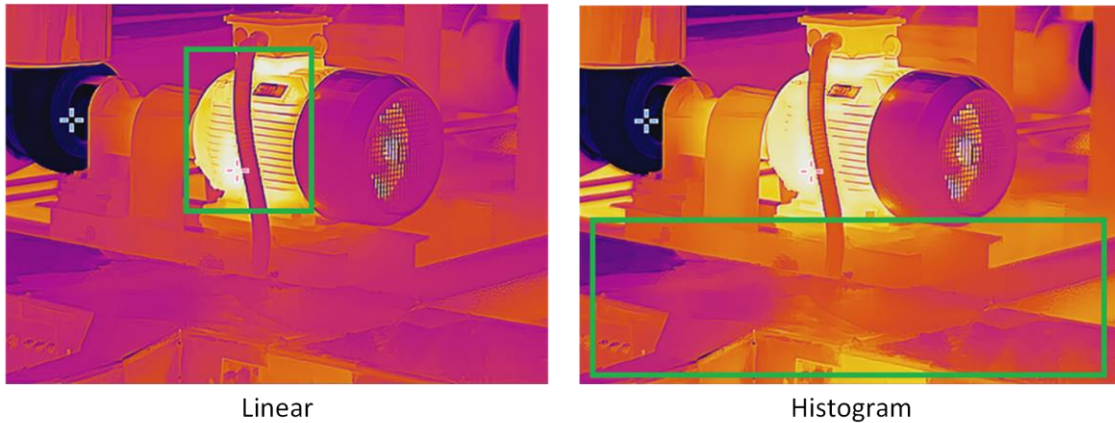



**Figure 4-1 Color Distribution**

## 4.2 Set Image Measurement

Device measures the temperature of the whole scene and can be managed to display the center, hot, and cold spot in the scene.

Press  to call the main menu and select  > . Select the desired spots to show their temperatures.

**Table 4-1 Icon Description**

Icon	Description
	Center spot of the scene (screen center). The temperature is displayed as <b>Cen XX</b> .
	Hot spot in the scene, which changes as the temperature or the scene changes. The temperature is displayed as <b>Max XX</b> .
	Cold spot in the scene, which changes as the temperature or the scene changes.



Icon	Description
	The temperature is displayed as <b>Min XX</b> .



Figure 4-2 Image Measurements



### 4.3 Set Measurement Tool

You can set temperature measurement parameters to improve the accuracy of temperature measurement.

#### Before You Start

Set parameters such as **Humidity**, **External Optics Transmittance** and **Reflection Temperature**. For detailed explanations, see [\*Set Measurement Parameters\*](#).

#### Steps

1. Press  to call the main menu.
2. Select  and press .
3. Select a type of temperature measurement tool

- Custom Spot**                      For configuring custom spot tools, see [\*Measure by Custom Spot\*](#).
  
- Line**                                      For the configuring line tools, see [\*Measure by Line\*](#).
  
- Rectangle**                              For the configuring rectangle tools, see [\*Measure by Rectangle\*](#).

- Circle** For the configuring circle tools, see ***Measure by Circle***.
- $\Delta T$**  For the configuring  $\Delta T$  tools, see ***Measure  $\Delta T$  and  $\Delta T$  Alarm***.



**Figure 4-3 Temperature Measurement Tool**



## What to do next

Set temperature alarm, then alarm actions such as audible warning and flashing alarm will be triggered when the tested temperature exceeds the set alarm value. See ***Temperature Alarm***.

### 4.3.1 Measure by Custom Spot

The device can detect the temperature of a custom spot.

#### Steps

1. Select .
2. Press  to add a custom spot.
3. Move the spot with the navigation buttons, or tap on the touch-screen to select a spot and move it.
4. Tap  to modify temperature measurement parameters.

#### Emissivity

Refer to ***Common Material Emissivity Reference*** to set the emissivity of your target.

#### Distance

Set the distance between the target and the device.

#### Temp.

Tap to display or hide the temperature measurement result.

5. Press .

---

#### Note

If the tool-specific emissivity and distance are set, the measurement is conducted based on the parameters. Otherwise, the parameters set from **Settings > Measurement Settings** are used for measurements.

---

The temperature of custom spot (e.g., P1) displays P1: XX.

6. Repeat the above steps to set other custom spots.

---

### Note

- At most ten custom spots are supported.
  - Drag the spot tool list on the left of the screen, or press  $\Delta$ ,  $\nabla$ ,  $\triangleleft$ , and  $\triangleright$  to view the whole tool list.
- 

7. Optional: Modify the set custom spot tools, hide or display the tools and measurement results, etc.



Tap to enter the editing interface and modify temperature measurement parameters such as emissivity and distance.



Tap to hide or display the tool and measurement results.



Tap to delete the tool.

8. Press  to save and exit.

## 4.3.2 Measure by Line

### Steps

1. Select .
  2. Press  to generate a default line.
- 

### Note

Only one line tool is supported.

---

3. Move the line to the required position.
  - Tap the line, and press  $\Delta$ ,  $\nabla$ ,  $\triangleleft$ , and  $\triangleright$  to move the line up/down/left/right.
  - Tap the line on touch-screen and drag it to the required position.
4. Adjust the length of the line.
  - Tap the end of the line, and press  $\Delta$ ,  $\nabla$ ,  $\triangleleft$  to extend or shorten the line.
  - Tap and drag the end of the line to extend or shorten it.
5. Tap  to modify temperature measurement parameters.

### Emissivity

Refer to ***Common Material Emissivity Reference*** to set the emissivity of your target.

### Distance

Set the distance between the target and the device.

### Max./Min./Average Temperature

Tap to enable the temperature types to display. The max. temperature, min. temperature, and average temperature of the line can be displayed on the left of the screen.

6. Press .

---

### **Note**

If the tool-specific emissivity and distance are set, the measurement is conducted based on the parameters. Otherwise, the parameters set from **Settings > Measurement Settings** are used for measurements.

---

7. Modify the set line tool, hide or display the tool and measurement results, etc.



Tap to enter the editing interface and modify temperature measurement parameters such as emissivity and distance.



Tap to hide or display the tool and measurement results.







Tap to delete the tool.

8. Press  to save and exit.

### 4.3.3 Measure by Rectangle

#### Steps

1. Select .
2. Press  or tap  to generate a default rectangle.
3. Move the rectangle to the required position.
  - Tap the rectangle, and press  $\Delta$ ,  $\nabla$ ,  $\triangleleft$ , and  $\triangleright$  to move the rectangle up/down/left/right.
  - Tap and drag the rectangle on touch-screen to move it to the required position.
4. Adjust the size of the rectangle.
  - Tap one corner of the rectangle, and press  $\Delta$ ,  $\nabla$ ,  $\triangleleft$  to enlarge or contract the rectangle.
  - Tap and drag the corner of the rectangle on touch-screen to enlarge or contract it.
5. Tap  to modify temperature measurement parameters.

#### Emissivity

Refer to ***Common Material Emissivity Reference*** to set the emissivity of your target.

#### Distance

Set the distance between the target and the device.

#### Max./Min./Average Temperature

Tap to enable the temperature types to display. The max. temperature, min. temperature, and average temperature of the rectangle area can be displayed on the left of the screen.

6. Press  to save the settings.

---

### Note

If the tool-specific emissivity and distance are set, the measurement is conducted based on the parameters. Otherwise, the parameters set from **Settings > Measurement Settings** are used for measurements.

---

7. Repeat the above steps to set other rectangle tools.

---

### Note

At most five rectangle tools are supported.

---

8. Optional: Modify the rectangle tools, hide or display the tools and measurement results, etc.



Tap to enter the editing interface and modify temperature measurement parameters such as emissivity and distance.



Tap to hide or display the tool and measurement results.







Tap to delete the tool.

9. Press  to save and exit.

## 4.3.4 Measure by Circle

### Steps

1. Select .
2. Press  or tap  to generate a default circle.
3. Move the circle to the required position.
  - Tap the circle, and press  $\Delta$ ,  $\nabla$ ,  $\triangleleft$ , and  $\triangleright$  to move the circle up/down/left/right.
  - Tap and drag the circle on touch-screen to move it to the required position.
4. Adjust the size of the circle.
  - Tap one point on the circle, and press  $\Delta$ ,  $\nabla$ ,  $\triangleleft$  to enlarge or contract the circle.
  - Tap and drag one point of the circle on touch-screen to enlarge or contract it.
5. Tap  to modify temperature measurement parameters.

### Emissivity

Refer to ***Common Material Emissivity Reference*** to set the emissivity of your target.

---

## Distance

Set the distance between the target and the device.

## Max./Min./Average Temperature

Tap to enable the temperature types to display. The max. temperature, min. temperature, and average temperature of the circle area can be displayed on the left of the screen.

6. Press  to save the settings.

---

### Note

If the tool-specific emissivity and distance are set, the measurement is conducted based on the parameters. Otherwise, the parameters set from **Settings > Measurement Settings** are used for measurements.

---

7. Repeat the above steps to set other rectangle tools.

---

### Note

At most five circle tools are supported.

---

8. Optional: Modify the circle tools, hide or display the tools and measurement results, etc.



Tap to enter the editing interface and modify temperature measurement parameters such as emissivity and distance.



Tap to hide or display the tool and measurement results.



Tap to delete the tool.

9. Press  to save and exit.

## 4.4 Measure $\Delta T$ and $\Delta T$ Alarm

By comparing the temperature difference ( $\Delta T$ ) between measurement tools, or between a measurement tool and a fixed temperature, device can recognize temperature exception more accurately and rapidly. This function is commonly applied to measure temperature-sensitive targets such as current transformers.

### Before You Start

Configure at least one temperature measurement tool.

- For configuring custom spot tools, see ***Measure by Custom Spot***.
- For the configuring line tools, see ***Measure by Line***.
- For the configuring rectangle tools, see ***Measure by Rectangle***.

- For the configuring circle tools, see ***Measure by Circle***.

### Steps

1. Select .
2. Add a  $\Delta T$  tool.
  - 1) Input a tool name for the  $\Delta T$  tool in **Name of Tool**.
  - 2) Select **Compared Object**.

---

#### **Note**

You can compare the temperature difference between different or the same measurement tools, between a measurement tool and a number, etc. If you select **Number** as a compared object, input the value manually.

---

- 3) Set **Alarming  $\Delta T$** .

When the detected  $\Delta T$  is greater than the set alarming  $\Delta T$ , device triggers alarms.
- 4) Tap **OK** to save the settings.
3. Optional: Repeat above steps to set other  $\Delta T$  tools.
4. Optional: Modify the  $\Delta T$  tools, hide or display the tools and measurement results, etc.



Tap to enter the editing interface and modify  $\Delta T$  tool parameters such as emissivity and distance.



Tap to hide or display the  $\Delta T$  tool and measurement results.



Tap to delete the  $\Delta T$  tool.

5. Press  to save and exit.
6. Enable  **$\Delta T$  Alarm**.
  - 1) Go to **Settings > Measurement Settings > Alarm Settings**.
  - 2) Tap to enable  **$\Delta T$  Alarm**.

---

#### **Note**

If you do not enable  $\Delta T$  Alarm, the alarm linkages also take effect, but the  $\Delta T$  alarm information will not be uploaded to the center.

---

## 4.5 Temperature Alarm

When the temperature of targets triggers the set alarm, the device will perform configured actions, such as, flashing the rule frame, making an audible warning, or sending notification to the client software.

### 4.5.1 Set Alarms for Exceptional Temperatures

Alarm actions such as audible warning and flashing alarm are triggered when the tested temperature exceeds the set alarm value.

#### Steps

1. Go to **Settings > Measurement Settings > Alarm Settings**.
2. Tap to enable **Temperature Alarm**.
3. Set the alarm parameters.

#### Alarm Threshold

When the tested temperature exceeds the threshold, the device sends alarm notification to the client software. It beeps if the audible warning is enabled. The rectangle flashes red if the rectangle tool is configured.

#### Alarm Linkage

- **Audible Warning:** The device beeps when target temperature exceeds the alarm threshold.
- **Flashing Alarm:** The flash light flashes when target temperature exceeds the alarm threshold.
- **Alarm Capture:** The device captures radiometric images when target temperature exceeds the alarm threshold.
- **Min. Alarm Interval:** It controls the minimal time interval between two alarm information uploading. It helps reduce repeated and frequent information receiving on the part of app and client software.

---

#### Note

If you set rectangle and circle tools to measure temperature, the alarm threshold and linkage method settings only works in the measured areas. Otherwise, the parameters are valid for pixel-to-pixel temperature measurement (whole-screen temperature measurement).

---



## 4.6 Clear All Measurements

Tap  to clear all set temperature measurement tools.

## Chapter 5 Condensation Alarm

Condensation alarm marks the surface where the relative humidity exceeds the set threshold.

### Steps

1. Select **Palettes** from the main menu.
2. Tap on .
3. Set ambient temperature, air relative humidity and humidity threshold for the alarm.

### Threshold

The surface humidity threshold. Anywhere with higher humidity in the scene is marked with green.

### Relative Humidity

The relative humidity of the environment around the target. This parameter helps the device calculate target humidity more accurately.

Relative humidity changes as your location and weather condition change. Check and reset the parameter every time you use the function.

You can refer to the value of your weather APP.

### Ambient Temp.

The ambient temperature of the target. This parameter helps the device calculate target humidity more accurately.

The ambient temperature changes as your location and weather condition change. Check and reset the parameter every time you use the function.

You can refer to the value of your weather APP.

4. Press **OK** to confirm the settings.

## Chapter 6 Route Inspection

In certain situations that require temperature check for many inspect points, you can use the client software to create inspection routes that cover all the points and send a route inspection task to the device. After the device examines the temperatures of the inspect points, it uploads the results to the client software.

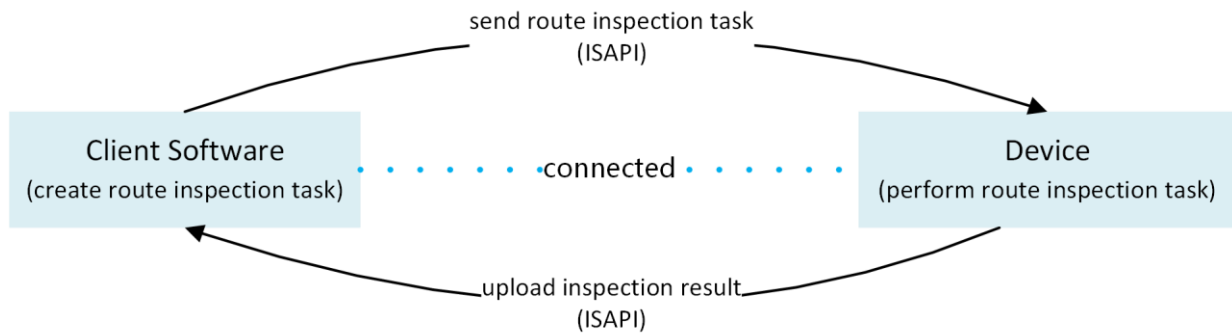

**Figure 6-1 Route Inspection Work Flow**

The device receives the tasks from and uploads the inspection results to the PC client software by its WLAN or Hotspot function.

### 6.1 Create Inspection Route and Send Task to Device

Create the inspection routes on HIKMICRO Inspector. The client should be connected to the device before sending the route inspection task.

#### Before You Start

Contact our technical support to get the HIKMICRO Inspector client software. Install the software to your PC.

The PC should support WLAN function.

#### Steps

1. Open HIKMICRO Inspector.
2. Create inspect points and routes. See the user manual of HIKMICRO Inspector for instructions.
3. Connect your device and PC to the same LAN. Available methods as below:
  - Connect your PC and your device to the same Wi-Fi network. For device Wi-Fi connection, go to **Settings > Connections > WLAN** to select and connect desired Wi-Fi network. See ***Connect Device to Wi-Fi*** for more instructions.
  - Connect your PC to the device hotspot. Turn on and set up device hotspot by **Settings > Connections > Hotspot**. See ***Set Device Hotspot*** for more instructions.

4. Click **Device Management** to add your device into the client. See the user manual of HIKMICRO Inspector for instructions.
5. Go to **Task Management > Route Management** to select a route and click **Apply to Device**.

### What to do next

Check your device to see if the task is successfully received.

## 6.2 Perform Route Inspection

After receiving inspection tasks from the PC client, you can hold the device and check the inspect points on the route. Upload the results when the inspection is finished.

### Before You Start



- Make sure your device has a memory card installed. See **Appearance** for instructions.
- Connect the device to the PC client, and make sure that your device has received inspection tasks from the PC client. See the user manual of HIKMICRO Inspector for instructions of applying inspection task to the device.

Use HIKMICRO Inspector v1.2.0.100 or newer versions to acquire full product functionality. Otherwise, operations mentioned below may not be available. Contact our technical support to get the software.

### Steps

1. Enter inspection mode to start.

Enter the mode by one of the following ways:



- Tap  on the swipe-down menu to enter the inspection route mode.
- Press  to call the menu, and go to **Settings > Device Settings > Inspection Route Mode** to enable the function.

---

### Note

When in the inspection route mode, the device file are not accessible.

---

2. Select an inspection route task.
  - In live view, press  to call the main menu, and select  to enter inspection task list.
  - In live view, press  to enter inspection task list.

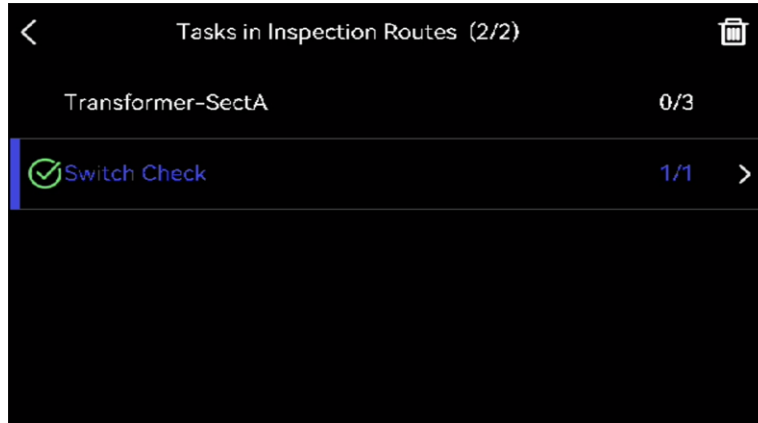

**Figure 6-2 Inspection Task List**

3. Select a task and press  $\text{OK}$  to switch to the task.

**Note**

The font of task in progress is blue on the list.

4. Browse the inspect points and check the inspection requirements for each point.

1) Press  $\text{OK}$  to enter the task interface.

2) Press  $\Delta$  and  $\nabla$  to select an inspect point and check the point details.

- Before inspecting points, check the point reference images (labeled as No. 4 in figure below) to confirm the image requirements and amount of capturing.
- Check the point parameters (labeled as No. 6 in figure below) to see if the point requires QR code scanning or not. If **Scanning Required is Required**, then you should scan the QR code to check in before capturing point images.
- Check diagnostic method of the point (labeled as No. 7 in figure below). If it is an auto-diagnosed point, it shows the diagnostic standard. If it is a manual diagnosed point, it shows diagnosis options.

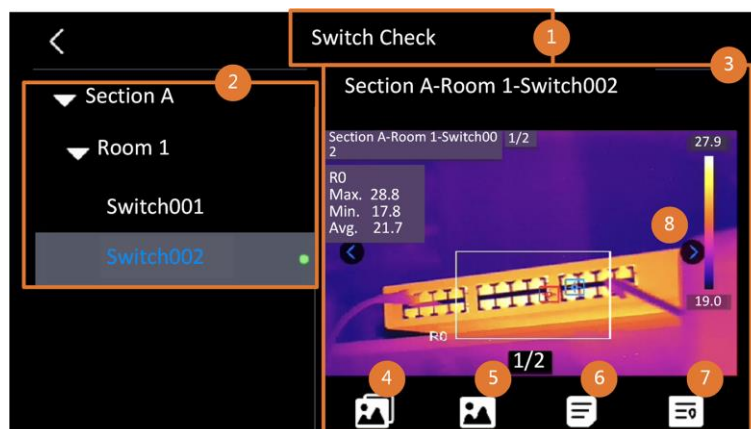

**Figure 6-3 Point Details**

**Table 6-1 Inspect Point Details**

No.	Descriptions
1	Inspection task name.
2	Inspect point list. Press $\Delta$ and $\nabla$ to select an inspect point and check the point details.
3	Display inspect point details.
4	Point reference images. They show the parts and angles of targets required for inspection. Capture inspection images as the reference images show. There may be several parts or angles should be inspected. Tap the left and right arrow (labeled as No. 8 in figure above) to browse all reference images.
5	Tap to browse saved inspection captures. Tap the left and right arrow (labeled as No. 8 in figure above) to switch captured images.
6	Tap to check the parameters of the selected point.
7	Check diagnostic information of the point.
8	Tap to switch images.

5. Inspect one point.

- 1) Press  and return to live view.
- 2) Optional: Move to an inspect point and aim the lens to the QR code and pull **Main Trigger** to scan and read the code.
- 3) Pull **Main Trigger** to capture inspect point images one by one according to the reference images until all required parts and angles of the point are captured.
- 4) After capturing the last required image, mark the diagnosis result.

 **Note**

For auto-diagnosed points, device marks the result according to the predefined diagnosis standards. For points that need manual diagnosis, choose a result option after last capture.

6. After inspection of one point, device switches to the next point automatically. Press  $\triangleleft$  and  $\triangleright$  to switch points.

7. Repeat above steps to complete inspection and diagnosis of all points.  
A completed task has  shown before the task name in the list.

**What to do next**

- You can delete inspection tasks by selecting a task and tapping .
- Upload the results to the PC client after finishing the route inspection. See the user

manual of HIKMICRO Inspector for instructions.

## 6.3 Upload Inspection Result and View Report

Upload the inspection results to the client software for central management and report generation.

### Before You Start

Connect your device with the PC that has the client software installed. See the step of device connection in ***Create Inspection Route and Send Task to Device*** for instructions.

### Steps

1. Open HIKMICRO Inspector.
2. Click  and **Task Management** and check desired tasks.
3. Click **Read Inspection Result** to download the results from the device.

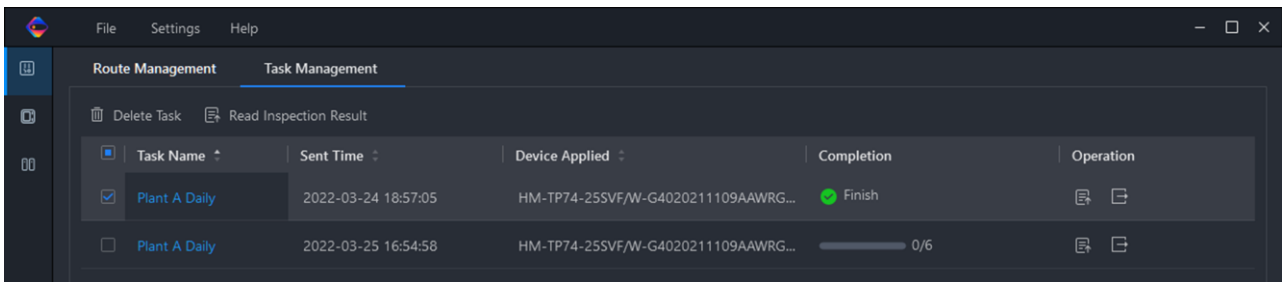

**Figure 6-4 Task Management**

The task status is shown in **Completion**.

4. Click on a finished task name to show result details.

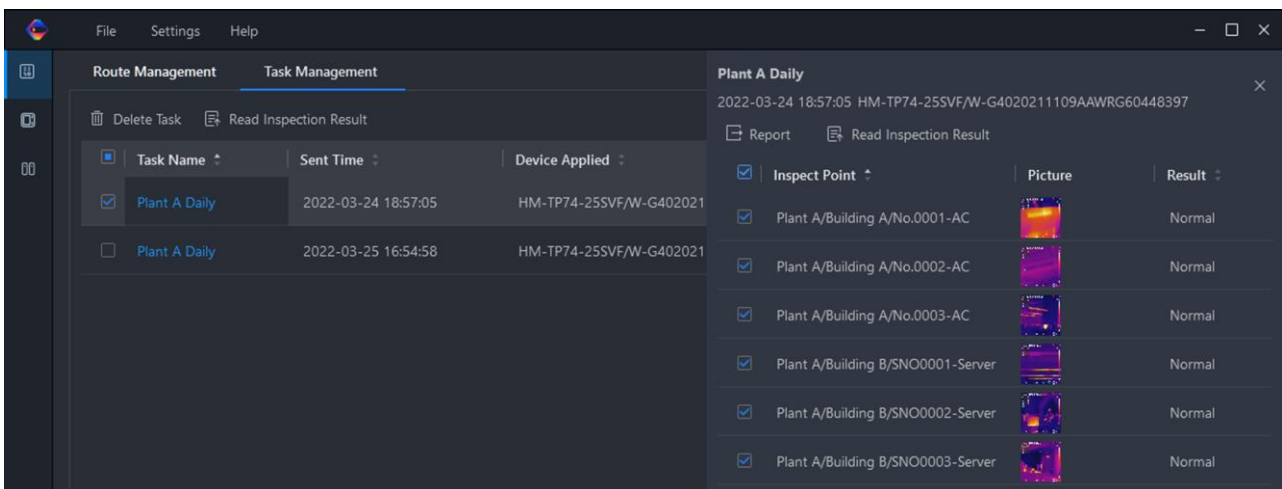

**Figure 6-5 Inspection Results**

5. Optional: Check a task or the desired inspect points and click **Report** for further analysis and report generation in HIKMICRO Analyzer.

## Note

- HIKMICRO Analyzer should be installed in your PC. Go to <https://www.hikmicrotech.com/en/industrial-products/hikmicro-analyzer-software/> to download the software and obtain more instructions.
- Please keep HIKMICRO Analyzer up-to-date for the best compatibility and user experience.

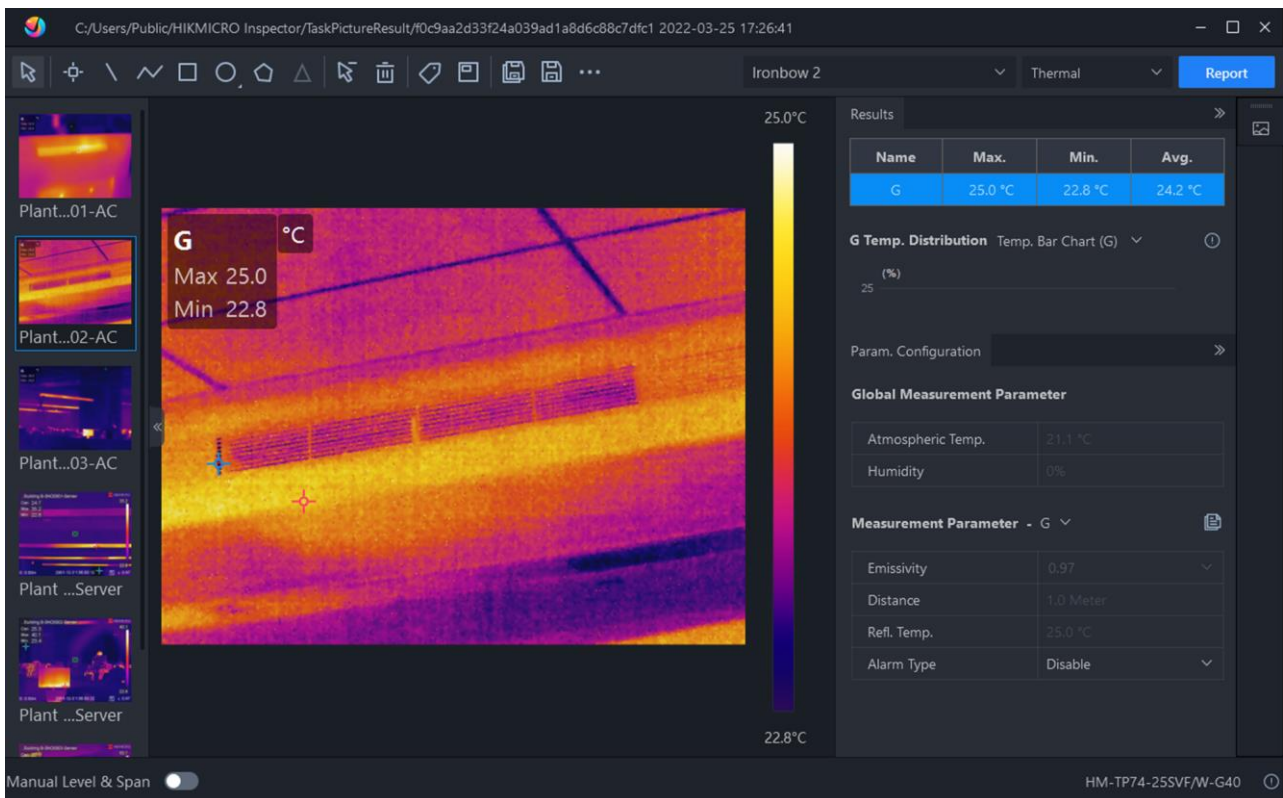

Figure 6-6 Analysis in HIKMICRO Analyzer



## Chapter 7 Picture and Video

Insert memory card into the device, and then you can record videos, capture images, and mark and save important data.

---

### Note

- Device does not support capturing or recording when the menu is shown.
  - When the device is connected to your PC, it does not support capturing or recording.
  - Go to **Settings > Capture Settings > Filename Header**, you can set the filename header for capturing or recording to distinguish the files recorded in a specific scene.
  - Go to **Settings > Device Settings > Device Initialization** to initialize the memory card is needed.
- 

## 7.1 Capture Picture

Operate the device to capture live images and save the images in local albums.

### Before You Start

Make sure that there is a working memory card mounted in your device. See [Appearance](#) to locate the memory card slot of your device.

### Steps

1. Set a capture mode and pull **Main Trigger** or tap  in live view interface to capture images.

There are 3 modes available. Each mode requires different operations.

- 1) Go to **Settings > Capture Settings > Capture Mode**.
- 2) Select a mode.

#### Capture One Image

Pull **Main Trigger** once to capture one image.

#### Continuous Capture

Set the continuous capture amount after select this mode.

Pull **Main Trigger** in live view, and device captures the set amount of images continuously.

#### Scheduled Capture

Set the interval for scheduled capture after select this mode.

Pull **Main Trigger** in live view, and the device captures images according to the set interval. Pull **Main Trigger** again or press  to stop capturing.







- 3) Press  to return to the live view interface.
- 4) Aim the lens to your target and pull **Main Trigger** to capture images.
  - Capture One Image: If **Edit before Saving** is NOT enabled (**Settings > Capture Settings**), the live image freezes and is saved in the default saving album. If **Edit before Saving** is enabled, the device enters the image editing interface.



Figure 7-1 Editing Image Before Saving



Table 7-1 Editing Options

No.	Descriptions
1	Text Note Select text note and enter the editing page. Tap on screen to input content and press  to save.
2	Voice Note <ul style="list-style-type: none"> <li>• Select voice note and enter voice recording page.</li> <li>• Press  or tap  to start recording. Press  or tap screen to stop recording.</li> <li>• <b>Optional:</b> You can tap to play the recording. If the voice note is unsatisfactory, tap to delete it. Repeat above steps to record again.</li> <li>• Press  to exit.</li> </ul>
3	Scan QR Code <ul style="list-style-type: none"> <li>• Select QR code and the device enters the scanning mode.</li> <li>• Aim the scanning frame at a QR code. Device reads the code and save the code information.</li> <li>• <b>Optional:</b> If the scanning fails, you can enter the code information using on-screen keyboard according to the prompt.</li> </ul>
4	After all information added to the image, select <b>Save</b> to exit.

- Continuous Capture/Scheduled Capture: A counter displays in top of the screen showing the completed amount of capturing.
2. Optional: You can set more capture settings as demanded.

Table 7-2 More Optional Capture Settings

Objective	Settings
Save an additional	Go to <b>Settings &gt; Capture Settings</b> .

Objective	Settings
visual image together with the thermal image.	<p>Enable <b>Save Visual Image</b> and set <b>Visual Image Resolution</b>.</p> <hr/> <p> <b>Note</b></p> <p>If the targets are in poor light condition, enable <b>Flashlight</b>. The device turns on the flashlight when capturing images.</p> <hr/>
Set the naming rule for images.	<ul style="list-style-type: none"> <li>● <b>Filename Header:</b> The default image naming is filename header + saving time. Filename header is configurable. Saving time is the device system time when the saving occurs. Go to <b>Settings &gt; Capture Settings &gt; Filename Header</b> to set filename header.</li> <li>● <b>File Naming:</b> The files can be named after <b>Time Stamp</b> or <b>Numbering</b> (filename header + sequence number). Go to <b>Settings &gt; Capture Settings &gt; File Naming</b> to set file naming.</li> </ul> <hr/> <p> <b>Note</b></p> <p>When using <b>Numbering</b>, the latest file cannot be saved when the sequence number of the existing filename is up to 99999. Remove the latest files in the album or change file naming to save new files.</p> <hr/>
View clear thermal image on high resolution screen.	<p>Go to <b>Settings &gt; Capture Settings</b>.</p> <p>Enable <b>SuperIR</b> before capturing. Resolution of captured images with <b>SuperIR</b> is about 4 times as the original one.</p>

**What to do next**

- Press  to enter albums to view and manage files and albums. See ***Manage Albums*** and ***Manage Files*** for operation instructions.
- To edit saved images, see ***Edit Images*** for operation instructions.
- You can connect your device to PC to export local files in albums for further use. See ***Export Files***.

## 7.2 Record Video

### Before You Start

A memory card should be mounted for video storage.

### Steps

1. Optional: Go to **Settings > Capture Settings > Video Type** to set the video format.

---

#### Note

Video type configuration is supported by certain models of this series. MP4 video type is adopted for the models of no such configuration option.

---

### Radiometric Video

Radiometric data is attached in videos of this format. They can only be played and further analyzed with HIKMICRO Analyzer.

---

#### Note

When the storage space is smaller than 500 MB, radiometric video recording is not allowed. Accidentally stopped recordings are not saved.

---

### MP4

Recorded videos are saved in .mp4 format. These video clips can be played on local device, and any player that support this format (HIKMICRO Analyzer does not support playing this video format.).

2. Optional: Set frame rate for the selected video type.
    - 1) Go to **Settings > Capture Settings > Video Type** to enable **Frame Rate Configuration**.
    - 2) Select **Frame Rate** and scroll to set a desired value.
- 

#### Note

- When **Frame Rate Configuration** is enabled, the camera's visual channel will be turned off. Therefore, you cannot change display mode or save the corresponding visual image when capturing a snapshot.
  - Higher frame rate offers a smoother video with more details for watching especially when motion occurs. But higher frame rate also means bigger video size which consumes more storage space.
- 

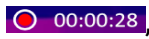

- 3) Press **OK**.
3. In the live view interface, hold the main trigger or long tap  in shortcut bar to start recording.

The recording signs for radiometric video and MP4 videos are different. When you see , it is recording a MP4 video. When you see **.rv** or **.hrv** (depending on frame rate) in live view, it is recording a radiometric video.

4. When you finish, pull the trigger again or tap  to stop recording. The video will be saved automatically and exit.

---

### Note

You can also press  or  to stop recording.

---





### What to do next

Check the saved videos from  in menu mode. See [View and Manage Local Files](#) for more information.

## 7.3 View and Manage Local Files

Device captured images and videos are saved in local albums. You can create, delete, rename and set an album as the default saving album. For files, operations, such as browsing, moving and deleting, are available.



### Steps





1. Enter albums.
  - In live view, press  to enter albums.
  - In live view, press  to call the main menu, and select  to enter albums.
2. To create, rename, delete and set an album as the default saving album, see [Manage Albums](#) for instructions.
3. For file operations, such as, moving or deleting a file, see [Manage Files](#) for instructions.
4. To modify an image, for example, editing the text or voice notes saved with the images, and changing the thermal parameters, see [Edit Images](#) for instructions.
5. Press  to exit.

### 7.3.1 Manage Albums

You can create several albums to manage captured images and video files on your device. Newly captured images and videos are saved in the **Default Saving Album** .

### Steps







1. In live view, press  to enter albums.
2. Create an album.
  - 1) Tap  in upper right corner to add an album.
  - 2) Edit the album name.

- 3) Press  to save the album.
3. Rename, delete or set an album as the default saving album.
  - 1) Select an album and press .
  - 2) Tap  in upper right corner of the screen.
  - 3) Select **Set as Default Saving Album, Rename** or **Delete** as required.  
The album icon turns to  when it is set as the default saving album.

## 7.3.2 Manage Files

Several formats of image video files are supported by the device. For certain format file, you can edit the attached notes and modify thermal parameters on device. For all files, you can check their basic information, delete or move them among albums.

### Steps







1. In live view, press  to enter albums. Select an album and press .
2. Browse the image and video files.
  - 1) Select a file and press .
  - 2) Press  and  to browse the previous or the next file.
  - 3) Press  to call the operation menu to check more available operations. File formats and their supported operations are shown below.

**Table 7-3 File Formats and Operations**

File Type	Format	Descriptions
Radiometric Images	File Name.jpeg	Editing text and voice notes, moving files, checking basic information, modifying thermal parameters, and deleting files are supported on device. See <b><i>Edit Images</i></b> for instructions.
MP4 Videos	File Name.mp4	Playing, moving and deleting video files are supported on device.
Radiometric Video	File name.rv, or file name.hrv	<p>File of this format cannot be played on your device. The file extension is determined by the frame rate of a video.</p> <p>Use HIKMICRO Analyzer to play and analyze the file. Please upgrade the software to the latest version, otherwise the .hrv file may not be supported.</p> <hr/> <p> <b>Note</b></p> <p>This file type is not supported by certain models of this series.</p>

File Type	Format	Descriptions



3. Moving or deleting several files.

- 1) In an album, tap  in the upper right corner of the screen.
- 2) Press  and  to select a file and press . If you want to select all files, tap  in the upper right corner. If you want to cancel all selection, tap . A selected file displays with a  in its upper right corner.
- 3) Tap **Delete** or **Move**.
  - If you tap delete, files are deleted after confirmation.
  - If you tap move, select a target album to start moving.

### 7.3.3 Edit Images

Editing the text or voice notes saved with the images, and changing the thermal parameters are allowed on your thermal camera.

**Steps**





1. Press  to enter **Albums**, and select and enter an album folder.
2. Select an image file and press  to call the editing menu.









**Figure 7-2 Editing Image**

3. Select an option and complete corresponding operations.

**Table 7-4 Editing and Managing Images**

No.	Description
1	Editing text note. Add a new text note or change the existed note, and press  to save the settings.
2	Editing voice note. You can add a new voice note, play or delete an existed voice note. <ul style="list-style-type: none"> <li>• If the file already has a voice note, tap to play or delete the note.</li> <li>• If the file has no voice note attached, press  or tap .</li> </ul>
3	Move the file to other albums. Select a target album and press  to confirm the moving.
4	Show basic information of the file, example the saving time, resolution

No.	Description
	of the file.
5	<p>Editing thermal parameters of the image.</p> <ol style="list-style-type: none"> <li>1. Press  or tap  to call the main menu.</li> <li>2. Modify the image display mode, measurement parameters and tools, palettes, and level &amp; span modes. For detailed operation instructions, see <b><i>Set Display Mode</i></b>, <b><i>Temperature Measurement</i></b>, <b><i>Set Palettes</i></b>, and <b><i>Adjust Display Temperature Range</i></b>.</li> <li>3. <b>Optional:</b> If you need a pdf report of the file, tap  on the upper right corner of the screen. Input <b>Report Name</b> and <b>Thermographer</b>, and tap  to generate the report.</li> </ol> <hr/> <p> <b>Note</b></p> <p>Generated reports are saved under the same path of the memory card as the image files. The PDF reports cannot be viewed on local device. Export and read reports on computers. See <b><i>Export Files</i></b> for instructions.</p> <hr/> <ol style="list-style-type: none"> <li>4. When finishing all operations, tap  to save the change and exit the editing interface.</li> </ol>
6	Delete the file.

## 7.4 Export Files

Connect the device to your PC with supplied cable, you can export the recorded videos and captured snapshots.

### Note

Cast screen should be turned off before exporting files.

Go to **Settings > Connections > USB Cast Screen** or call the swipe-down menu to turn off this function.

### Steps

1. Open the cover of cable interface.
2. Connect the device to your PC with cable and open the detected disk.
3. Select and copy the videos or snapshots to PC to view the files.
4. Disconnect the device from your PC.



---

 **Note**

For the first time connection, the driver will be installed automatically.

---

**What to do next**

You can import the captured snapshots to HIKMICRO Analyzer for further data analysis.

## Chapter 8 Calculate Area Size

The device can calculate the size of rectangles and show results on screen.

### Steps

1. Go to **Settings > Measurement Settings > Area Size Calculation**.
2. Enable **Area Size Calculation**.
3. Draw one or several rectangles on screen.

The rectangles are those you draw for temperature measurement. See ***Measure by Rectangle*** for instructions.

4. In the live view interface, aim a rectangle at the target and press the laser button.

---

### Note

Make sure the lens is parallel to the target when measuring the area size.

---

### Result

The target size is displayed above the rectangle.



## Chapter 9 Distance Detection

The laser range finder consists of a laser transmitter and a laser receiver. The device detects the distance to a target by measuring the time it takes for a laser pulse to reach the target and return to the laser receiver. This time is converted to a distance, which is displayed on the screen.

### Before You Start

- It is recommended to use this function in non-glare environment, such as indoor environment.
- It is recommended that the target has good light reflection, such as white paper and cable.

### Steps

1. Press  in live view to show main menu.
2. Select , and enter **Display Settings**.
3. Enable **Distance**.
4. Press  to save and exit.
5. In the live view interface, aim the cursor at the target and hold the laser button. Release the laser button to finish distance measurement.

The distance displays on the screen when distance measurement is finished.

## Chapter 10 Geographic Location Display

Equipped with satellite positioning modules, the device is able to display its longitude and latitude on the live image and in the captured images.

---

### Note

The function is only supported by certain models.

---

Go to **Settings > Device Settings > GPS** to enable the satellite positioning modules, and you can see the location displayed at lower right corner of the screen.

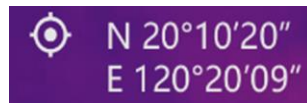

**Figure 10-1 Location Display**

---

### Note

- The satellite module is not able to receive signals when the device is indoor. Place the device in an empty outdoor space to receive signals.
  - In an outdoor space, wait for a moment for the device to display its location.
  - The location information is also attached in captured radiometric images. You can read the location by HIKMICRO Analyzer.
  - Location display is only supported by models with satellite positioning modules.
-

## Chapter 11 Direction Display

Equipped with a compass, the device is able to display its direction on the live image and in the captured images.

---

### Note

The function is supported by certain models.

---

Go to **Settings > Device Settings > Compass** to enable the compass modules, then follow the pop-up instructions to calibrate the compass. See [\*Calibrate Compass\*](#) for more information.

After successful calibration, you can see the direction displayed at lower right corner of the screen. It is recommended to read the direction when you lay the device horizontally. To increase the direction accuracy, you can set the magnetic declination correction. See [\*Magnetic Declination Correction\*](#) for instructions.

---

### Note

The direction information is also attached in captured radiometric images. You can read the direction by HIKMICRO Analyzer.

---

### 11.1 Calibrate Compass

Compass calibration is a must for correct direction display.

You need to calibrate the compass when you enable the function for the first time.

#### Steps

1. Call the calibration guide by the following ways.
  - When you enable compass for the first time, or the compass is magnetically interfered, compass calibration guide pops up.
  - Go to **Settings > Device Settings > Compass** to turn the function off and on again.
2. Follow the screen instructions to move and rotate the device.

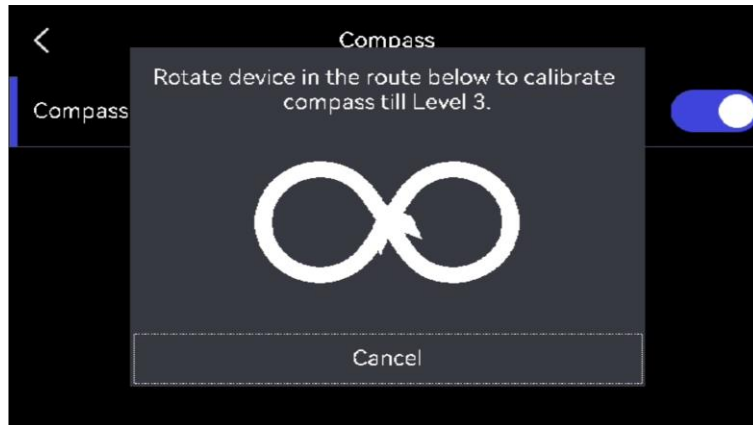

---

### Note

During calibration, keep moving and rotating the device to make sure that the device faces every possible directions.

---

3. Stop moving the device when calibration success message pops up.

### Result

The status bar in the live view interface shows  after successful calibration. If the number in this icon is smaller than 3, it means that the compass is not properly calibrated and the direction displayed might not be correct.

## 11.2 Magnetic Declination Correction

Magnetic declination is the angle variation between magnetic north and true north. Adding the magnetic declination to the compass increase the accuracy of direction reading.

Go to **Settings > Device Settings > Compass > Magnetic Declination Correction** to add the declination of device location.

## Chapter 12 Thermal View Mobile Client Connection

The device supports both Wi-Fi connection and hotspot. Connect the device to HIKMICRO Viewer, and you can control the device via mobile client.

### 12.1 Connect via Wi-Fi

#### Before You Start

Download and install HIKMICRO Viewer on your phone.

#### Steps

1. Connect your device to a Wi-Fi network. See [\*\*\*Connect Device to Wi-Fi\*\*\*](#) for instructions.
2. Connect your phone to the Wi-Fi network that the device is in.
3. Launch the app and follow the startup wizard to create, and register an account.
4. Search and add the device to the mobile client.

#### Result

You can view the live view, capture snapshots, and record videos via the client.

### 12.2 Connect via Hotspot

#### Before You Start

Download and install HIKMICRO Viewer on your phone.

#### Steps



1. Turn on the device hotspot and complete hotspot settings. See [\*\*\*Set Device Hotspot\*\*\*](#) for instructions.
2. Connect your phone to the hotspot of the device.
3. Launch the app and follow the startup wizard to create, and register an account.
4. Search and add the device to the mobile client.

#### Result

You can view the live view, capture snapshots, and record videos via the client.

## Chapter 13 Connect Device to Wi-Fi

### Steps

1. Enter Wi-Fi setting interface. Choose from the following ways.
  - Tap and hold  from the swipe-down menu.
  - Go to **Settings > Connections > WLAN**.
2. Tap  to enable Wi-Fi, and the searched Wi-Fi will be listed.

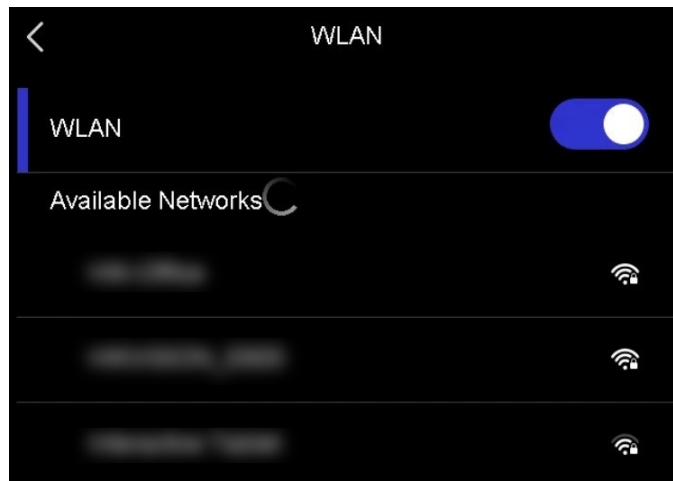



Figure 13-1 Wi-Fi List

3. Select Wi-Fi to connect to and a soft keyboard is displayed.
4. Enter the password.
5. Tap  to hide the keypad and connect Wi-Fi.

---

### Note

- DO NOT tap **space**, or the password may be incorrect.
  - Leaving the Wi-Fi setting interface does not interrupt the connection.
- 

### Result

A Wi-Fi icon shows on the main interface when the connection is completed.

### What to do next



You can turn off/on Wi-Fi connection from the swipe-down menu .



## Chapter 14 Set Device Hotspot

With the device hotspot, other equipment with Wi-Fi function can join the device for data transmission.

### Steps

1. Enter hotspot configuration interface. Choose from the following ways.
  - Tap and hold  from swipe-down.
  - Go to **Settings > Connections > Hotspot**.
2. Tap  to enable hotspot function.

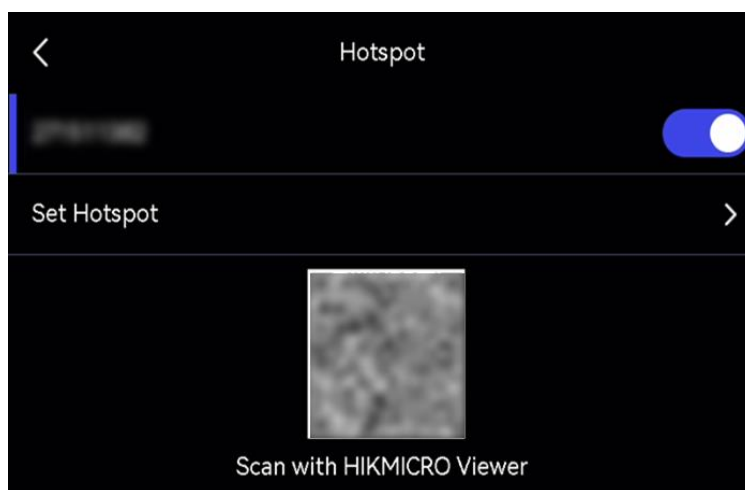

**Figure 14-1 Set Hotspot**

3. Set and join the hotspot.

#### Using hotspot password

1. Tap **Set Hotspot**. A soft keyboard is displayed.
2. Set the password for the hotspot by tapping the screen.
3. Tap  to save.
4. Enable the Wi-Fi function of other equipment and search the device hotspot to join.

#### Using hotspot QR code

1. A QR code is displayed.
2. Scan the QR code with HIKMICRO Viewer to join the hotspot.

---

### Note

- When setting the password, do not tap **space**, or the password may be incorrect.
  - The password should be at least 8 digits, consisting of numbers and characters.
-



### **What to do next**

You can tap  to turn off/on device hotspot from the swipe-down menu.

## Chapter 15 Pair Bluetooth Devices

Pair your camera with an external bluetooth player (speaker or headsets) to play the audio recorded together with the videos and the images.

### Steps

1. Enter bluebooth configuration page. Choose from the following ways.
  - Tap and hold  from swipe-down menu.
  - Select  from the main menu. Go to **Settings** > **Connections** > **Bluetooth**.
2. Tap on  to enable the bluetooth.

---

### Note

Make sure the external bluetooth device is in discoverable mode.

---

The device searches and displays available nearby bluetooth devices.

3. Tap to select an external bluetooth device to start automatic pairing and connecting.

### What to do next

You can tap  to turn off/on bluetooth from the swipe-down menu.

## Chapter 16 Set LED Light

Press  $\Delta$  in live view to turn on/off the LED light. Or tap  in the swipe-down menu to quickly turn on/off LED light.

## Chapter 17 Cast Device Screen to PC

The device supports casting screen to PC by UVC protocol-based client software or player. You can connect the device to your PC via a type-C cable, and cast the real-time live view of the device to your PC.

### Steps

1. Go to **Settings > Connections > USB Cast Screen** to turn on the function on device. Or tap  in the swipe-down menu to turn on/off **USB Cast Screen**.
2. Open the UVC protocol-based client software on your PC.
3. Use a type-C cable to connect your device with PC.

### What to do next

For more instructions about how to cast the screen, please visit our website:

<https://www.hikmicrotech.com/>



## Chapter 18 Image Local Output

You can view the image on the display unit for details with this function.

### Before You Start

- This function is only supported by the models with CVBS output interface or micro HDMI output interface.
- If your device has a micro HDMI output interface, connect the device and a display unit to cast the image. No more settings are required. If your device has CVBS out interface, connect the device and the display unit via a CVBS cable, and set the device according to the steps below.
- Make sure the device is turned off when connecting the cable.

### Steps

1. Go to **Settings > Image Settings > CVBS Output**.
2. Tap  to enable CVBS output.
3. Press  to save and exit.

The display unit show the device image.

## Chapter 19 Maintenance

### 19.1 View Device Information

Go to **Settings > Device Settings > Device Information** to view the device information.

### 19.2 Set Date and Time

#### Steps

1. Go to **Settings > Device Settings > Time and Date**.
2. Set the date and time.
3. Press  to save and exit.

---

#### Note

Go to **Settings > Display Settings** to enable time and date on-screen display.

---

### 19.3 Upgrade Device

#### Before You Start

- Please download the upgrade file from the official website <http://www.hikmicrotech.com> or contact the custom service and technical support to get the upgrade file first.
- Make sure that the device battery is fully charged.
- Make sure that USB Cast Screen function is turned off.
- Make sure that Auto Power-off function is turned-off to avoid accidental suspension during upgrading.
- Make sure that a memory card has been installed to device.

#### Steps

1. Connect the device to your PC with a type-A to type-C cable and open the detected disk.
2. Unzip the file, and copy the upgrade file and paste it to the root directory of the device.
3. Disconnect the device from your PC.
4. Reboot the device and then it will upgrade automatically. The upgrading process will be displayed in the main interface.

### Note

- You can also upgrade the device via HIKMICRO Viewer. Please refer to the user manual of the app for more information.
  - After upgrading, the device reboots automatically. You can view the current version in **Settings > Device Settings > Device Information**.
- 

## 19.4 Restore Device

Go to **Settings > Device Settings > Device Initialization** to initialize the device and restore default settings.

## 19.5 Initialize Memory Card

When a memory card is use on the handheld thermal camera for the first time, it needs to be initialized first.

Go to **Settings > Device Settings > Device Initialization** to initialize the memory card.

---

### Caution

If there are files in the memory card, make sure that the files has been backed up before memory card initialization. Once the card is initialized, data and files cannot be recovered.

---

## 19.6 About Calibration

We recommend you send the device back for calibration once a year, and please contact the local dealer for the information on maintenance points. For more detailed calibration services, please refer to <https://www.hikmicrotech.com/en/support/calibration-service/>.



## Chapter 20 Appendix

### 20.1 Common Material Emissivity Reference

Material	Emissivity
Human Skin	0.98
Printed Circuit Board	0.91
Concrete	0.95
Ceramic	0.92
Rubber	0.95
Paint	0.93
Wood	0.85
Pitch	0.96
Brick	0.95
Sand	0.90
Soil	0.92
Cloth	0.98
Hard Paperboard	0.90
White Paper	0.90
Water	0.96

### 20.2 FAQ

Scan the following QR code to get device common FAQ.





**HIKMICRO**

See the World in a New Way