

E03 Pocket Series Handheld Thermal Camera



HIKMICRO E03 has a high-resolution VOx detector, an 0.3 MP optical camera, and a 3.5" LCD touch screen. It helps you quickly and efficiently locate hidden problems and accurately measure abnormal temperatures. The wide temperature range of -20°C to 350°C is ideal for building inspection, HVAC, electrical, and mechanical equipment maintenance. The 25 Hz frame rate keeps up with fast inspection. The Pocket Series is a powerful thermography tool in your pocket, so it is always there whenever you need it.

▪ Features

- Thermal resolution: 96 × 96 (9,216 pixels), NETD: < 50 mK (@ 25°C, F# = 1.0)
- SuperIR: 240 x 240 (57,600 pixels)
- Accurately measure temperature from -20°C to 350°C (-4°F to 662°F)
- 15:1 Distance to spot ratio (D:S)
- Accuracy: Max. (± 2°C/3.6°F, ± 2%)
- Thermal, Fusion, Visual
- Manual, automatic, and 1-Tap level and span
- High temperature alarm
- Built-in 4 GB memory
- LED work light
- 1.0x to 4.0x continuous digital zoom
- 0.3MP visual camera

▪ Specification

Infrared Image	
IR Resolution	96 × 96 (9, 216 pixels)
SuperIR	240 x 240 (57,600 pixels)
Distance to Spot Ratio (D:S)	15:1
NETD	< 50 mK (@ 25 °C, F#=1.0)
Image Frequency	25 Hz
Detector Pitch	12 μm
Spectral Range	7.5 to 14 μm
Focal Length	1.35 mm
F-number	F1.0
Field of View (FOV)	50° × 50°
Spatial Resolution (IFOV)	8.89 mrad
Min. Focus Distance	0.1 m (0.33 ft)
Focus Mode	Focus Free
Image Display	
Display	320 × 240 Resolution, 3.5" LCD Touch Screen
Image Modes	Thermal/Visual/Fusion
Color Palettes	White Hot, Black Hot, Rainbow, Ironbow, Rain, Blue Red
Visual Camera	640× 480 (0.3 MP)
Screen Brightness	Manual
Digital Zoom	1.0x to 4.0x continuous
Measurement and Analysis	
SuperScene Mode	Custom, Water Leak, Insulation, Floor Heating, Electrical Faults, Solar Panel
Smart SuperScene Alarm	Water Leak, Insulation, Floor Heating
Alarm	More than, Less than
Alarm Linkage	Flashing Alarm, Alarm Mode Palettes
Temperature Measurement Mode	Measurements presets (center spot, max spot, min spot, off)
Object Temperature Range	-20°C to 350°C (-4°F to 662°F)
Accuracy	Max (±2°C/3.6°F, ±2%) at ambient temperature 25°C (77°F) and object temperature above 0°C (32°F)
Level and Span Mode	Auto/Manual/1-Tap Touch-screen
Data Storage and Communication	
Storage Media	Built-in 4 GB flash memory (user available storage space is less than the nominal capacity)
Image Storage Capacity	Approx. 20,000 Images
Image File Format	Radiometric JPEG
Video Storage Capacity	Approx. 37 hours
Video File Format	MP4 video
Annotations	Text note: max. 255 characters
Radiometric Infrared-Video Streaming (Compressed)	Over UVC
General	
USB Interface	USB Type-C
LED Light	Yes

Battery Type	Rechargeable Li-ion Battery
Battery Operating Time	Approx. 4 hours
Battery Charging Time	Approx. 3 hours fully charged
Protection Level	IP54
Drop Test Height	2 m (6.56 ft)
Working Temperature Range	-10°C to 50°C (14°F to 122°F)
Storage Temperature Range	-20°C to 60°C (-4°F to 140°F)
Relative Humidity	< 95% non-condensing
Weight	Approx. 218 g (0.481 lb)
Dimension	138.45 × 85.2 × 23.65 mm (5.45 × 3.35 × 0.93 in)
Tripod Mounting	UNC ¼"-20
Power Supply	USB-C (5V/2A)

▪ Dimension

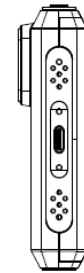
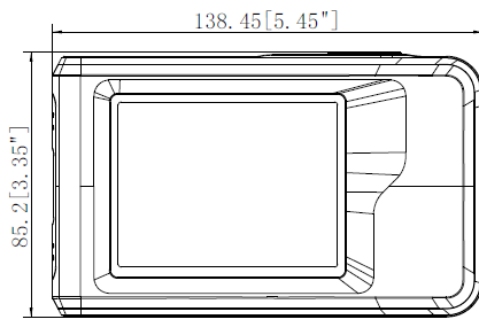
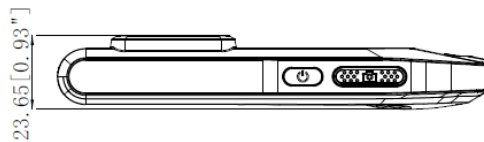

Unit: mm[inch]

▪ Packaging List

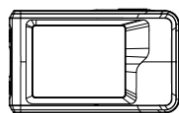

E03 (X1)



QSG (X1)

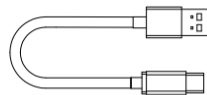

USB Cable (X1)

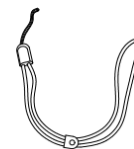

Wrist Strap (X1)

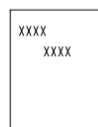

Calibration Certificate (X1)

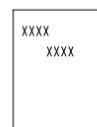

Information For
Private
Households (X1)

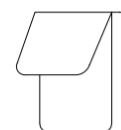

Carrying Pouch (X1)



COMPLIANCE NOTICE: The thermal series products might be subject to export controls in various countries or regions, including without limitation, the United States, European Union, United Kingdom and/or other member countries of the Wassenaar Arrangement. Please consult your professional legal or compliance expert or local government authorities for any necessary export license requirements if you intend to transfer, export, re-export the thermal series products between different countries.



 Hikmicro Industrial

 hikmicro_industrial

 HIKMICRO Industrial

 HIKMICRO

 info@hikmicrotech.com

 www.hikmicrotech.com

© Hangzhou Microimage Software Co., Ltd. All Rights Reserved.

*Note: Specifications are subject to change without notice. For the current specs,
please go to www.hikmicrotech.com