



Thermal Image Scope

HIKMICRO STELLAR Series

User Manual V5.5.54 202212



Contact Us

Table of Contents

Chapter 1 Overview.....	1
1.1 Device Description.....	1
1.2 Main Function.....	1
1.3 Appearance.....	1
Chapter 2 Preparation	3
2.1 Cable Connection.....	3
2.2 Install Battery	3
2.2.1 Battery Instruction	3
2.2.2 Battery Installation.....	3
2.3 Power On/Off	4
2.4 Menu Description	5
2.5 Firmware Status	5
2.5.1 Client Software Connection	5
2.5.2 Check Firmware Status.....	6
2.5.3 Upgrade Device	7
2.6 Zeroing	8
Chapter 3 Image Settings.....	9
3.1 Adjust Diopter	9
3.2 Adjust Focus.....	9
3.3 Adjust Brightness.....	10
3.4 Adjust Contrast.....	10
3.5 Select Scene Mode	10
3.6 Set Palettes	10
3.7 Correct Defective Pixel	12
3.8 Flat Field Correction	13
3.9 Set Picture in Picture Mode	13
3.10 Adjust Digital Zoom.....	14
Chapter 4 Zeroing.....	15
4.1 Select Reticle Group	15
4.2 Set Reticle	15

Thermal Image Scope User Manual

4.3 Correct Reticle	17
Chapter 5 Measure Distance.....	19
Chapter 6 General Settings.....	20
6.1 Set OSD	20
6.2 Set Brand Logo.....	20
6.3 Burning Prevention	21
6.4 Capture and Video.....	21
6.4.1 Capture Picture.....	21
6.4.2 Set Audio	21
6.4.3 Record Video	22
6.4.4 Prerecord Video.....	22
6.5 Hot Tracking.....	23
6.6 Export Files	23
Chapter 7 System Settings	25
7.1 Synchronize Time	25
7.2 Language Settings.....	25
7.3 Unit Settings	25
7.4 View Device Information	25
7.5 Restore Device.....	26
Chapter 8 Frequently Asked Questions	27
8.1 Why is the monitor off?	27
8.2 The image is not clear, how to adjust it?	27
8.3 Capturing or recording fails. What's the problem?	27
8.4 Why the PC cannot identify the device?	27
Chapter 9 Appendix.....	28
9.1 Device Command.....	28
9.2 Device Communication Matrix	28
Safety Instruction.....	29
Legal Information.....	31
Regulatory Information	32

Chapter 1 Overview

1.1 Device Description

HIKMICRO STELLAR Thermal Image Scope provides clear image under harsh environment conditions like darkness, fog, smoke, dust, rain, snow, wood, camouflage, etc. The traditional-style 50mm Tube meets the needs of professional hunters who value traditions and seek technological superiority, ensuring an extreme detection range.

1.2 Main Function

- Distance Measurement: The device can detect the distance between the target and the device.
- Hot Tracking: The device can detect the highest temperature in the scene and mark the spot.
- Zeroing: The reticle helps you to aim at the target fast and accurately. See **Zeroing**.
- Client Software Connection: The device can capture snapshots, record videos, and set parameters by HIKMICRO Sight app after being connected to your phone via hotspot.
- Image Correction: The device supports DPC (Defective Pixel Correction) and FFC (Flat Field Correction) which can optimize the image quality.

1.3 Appearance

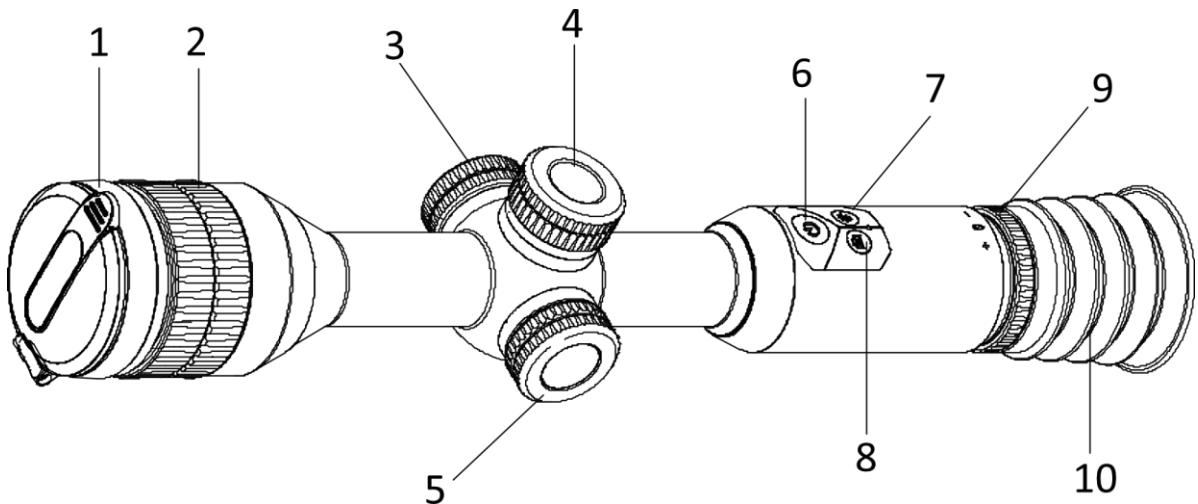

Figure 1-1 Buttons and Components

Table 1-1 Description of Buttons and Components

No.	Component	Function
1	Lens Cover	Protects the lens.
2	Focus Ring	Adjusts focus to obtain clear targets.
3	Type-C Interface	To connect the device to power supply or transmit data with a type-C cable.
4	Battery Compartment	For holding the battery.
5	Wheel	<ul style="list-style-type: none">● Hold: Enter/Exit menu● Rotate: Switch digital zoom
6	Power Key	<ul style="list-style-type: none">● Press: Standby mode/Wake up device● Hold: Power on/off
7	Palettes Key	<ul style="list-style-type: none">● Press: Switch palettes● Hold: Manual FFC
8	Capture Key	<ul style="list-style-type: none">● Press: Capture snapshot● Hold: Start/Stop recording
9	Diopter Adjustment Ring	Adjusts the dioptic setting.
10	Eyepiece	The piece placed closest to the eye to view the target.

 **Note**

Switch reticle: Press Capture Key and Palettes Key at the same time in the live view mode.

Chapter 2 Preparation

2.1 Cable Connection

Connect the device and power adaptor with a type-C cable to charge the device. Alternatively, connect the device and PC to export files.

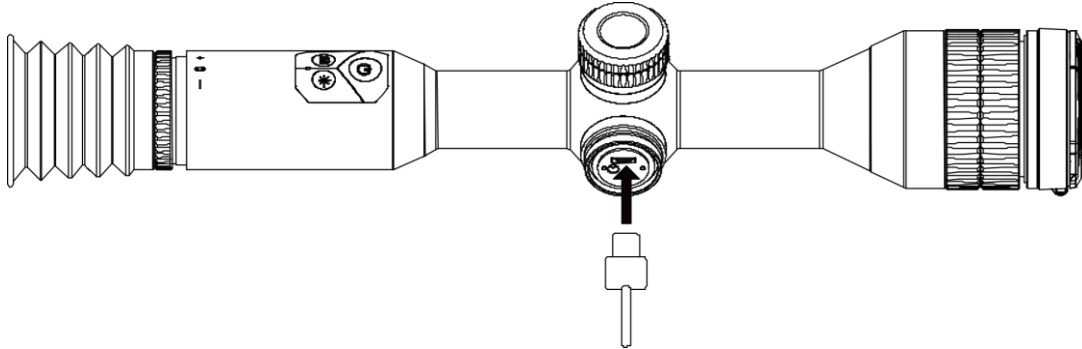

Figure 2-1 Cable Connection

2.2 Install Battery

2.2.1 Battery Instruction

- Charge the device for more than 4 hours before first use.
- The built-in battery type is 18650 with the protection board, and the battery size should be 23 mm × 67 mm. The rated voltage and capacity are 3.6 VDC/3350 mAh (12.18 Wh).
- The external removable battery type is CR123A. The max. rated voltage is 3 VDC/2 A, and the battery capacity is 1600 mAh.
- Do not charge the removable battery in the package.
- Install the external battery before the built-in battery runs out, or the device cannot be turned on.

2.2.2 Battery Installation

Insert the batteries into the battery compartment.

Steps

1. Turn the battery cover anticlockwise to loosen it.

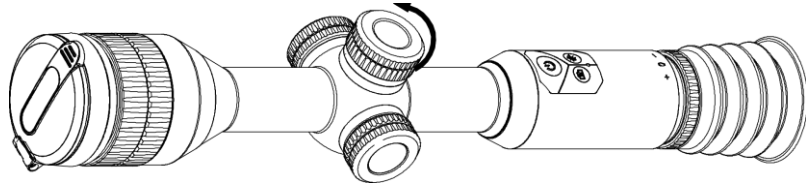

Figure 2-2 Loosen the Cover

2. Insert the battery into the battery compartment with the positive mark inward.

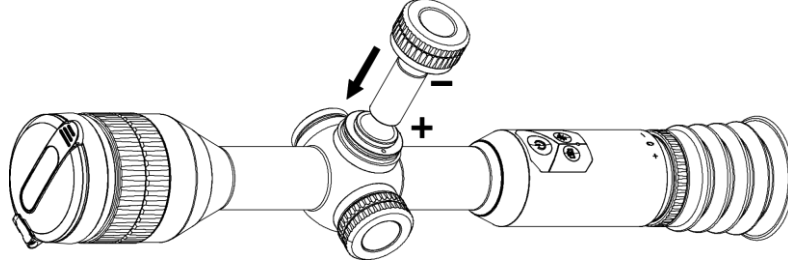

Figure 2-3 Install the Battery

3. Turn the battery cover clockwise to tighten it.

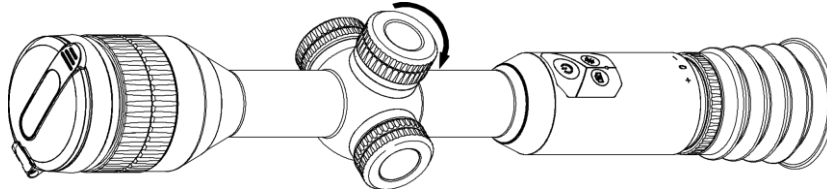

Figure 2-4 Tighten the Cover

Note

Remove the battery if the device is not used for a long time.

2.3 Power On/Off

Power On

When the battery is sufficiently charged, press  to power on the device.

Power Off

When the device is turned on, hold  for 2 seconds to power off the device.

Note

- Power-off countdown will appear when you power off the device. You can press any key to interrupt the countdown and cancel the power-off.
 - Automatic low battery power-off cannot be canceled.
-



Auto Power Off

You can set the auto power off time for your device.

Steps

1. Hold the wheel to go to the menu.
2. Rotate the wheel to select , and press the wheel to select the auto power off time as required.
3. Hold the wheel to save and exit.

Note

- See the battery icon for the electricity quantity.  means the battery is fully charged, and  means that the battery is low.
 - When the low power note shows, charge the battery.
-

2.4 Menu Description

When the device is turned on, hold the wheel to show the menu.

In the menu, you can rotate the wheel to select functions, press the wheel to configure the selected function, and hold the wheel to exit the menu.

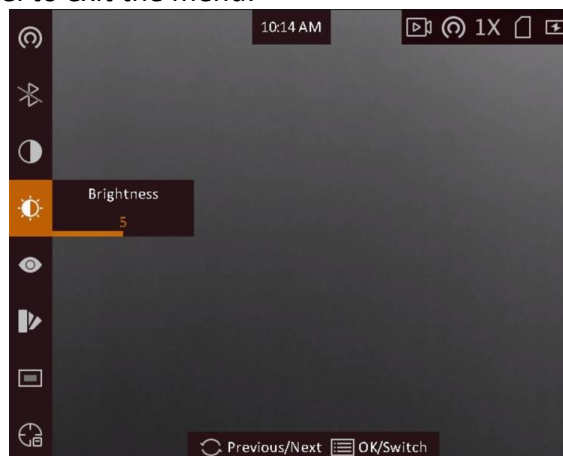

Figure 2-5 Menu Interface

2.5 Firmware Status

2.5.1 Client Software Connection

Connect the device to the HIKMICRO Sight app via hotspot, and then you can capture picture,

record video, or configure parameters on your phone.

Steps

1. Hold the wheel to show the menu of device.
2. Press  to enable hotspot function.
3. Turn on the WLAN of your phone and connect to the hotspot.
 - Hotspot Name: HIK-IPTS Serial No.
 - Hotspot Password: Serial No.
4. Search the HIKMICRO Sight app on App Store (iOS System) or Google Play™ (Android System) to download it, or scan the QR code to download and install the app.



Android System



iOS System

5. Open the app and connect your phone with the device. You can view the interface of device on your phone.

Note

- The device cannot connect to the App if entering wrong password several times. Refer to **Restore Device** to reset the device, and connect the app again.
 - The device should be activated for the first use. The default password must be changed after the activation.
-

2.5.2 Check Firmware Status

Steps

1. Open the HIKMICRO Sight and connect your device to the app.
2. Check if there is a red spot on the connection interface. If there is no red spot, the firmware is the latest version. Otherwise, the firmware is not the latest version.

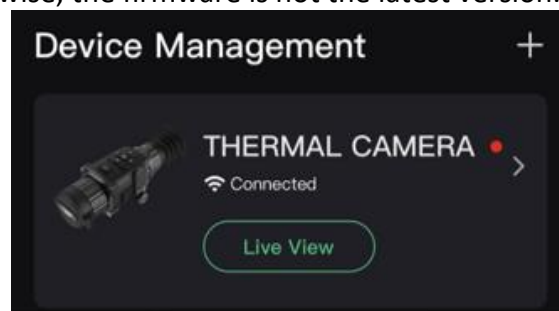

Figure 2-6 Check Firmware Status

3. (Optional) If the firmware is not the latest version, upgrade the device. See **Upgrade Device**.

2.5.3 Upgrade Device

Upgrade Device via HIKMICRO Sight

Before You Start

Install HIKMICRO Sight on your phone and connect your device to the app.

Steps

1. Tap the device series to enter the device information interface.
2. Tap **Device Upgrade** to enter the firmware upgrade interface
3. Tap **Upgrade** to start upgrade.

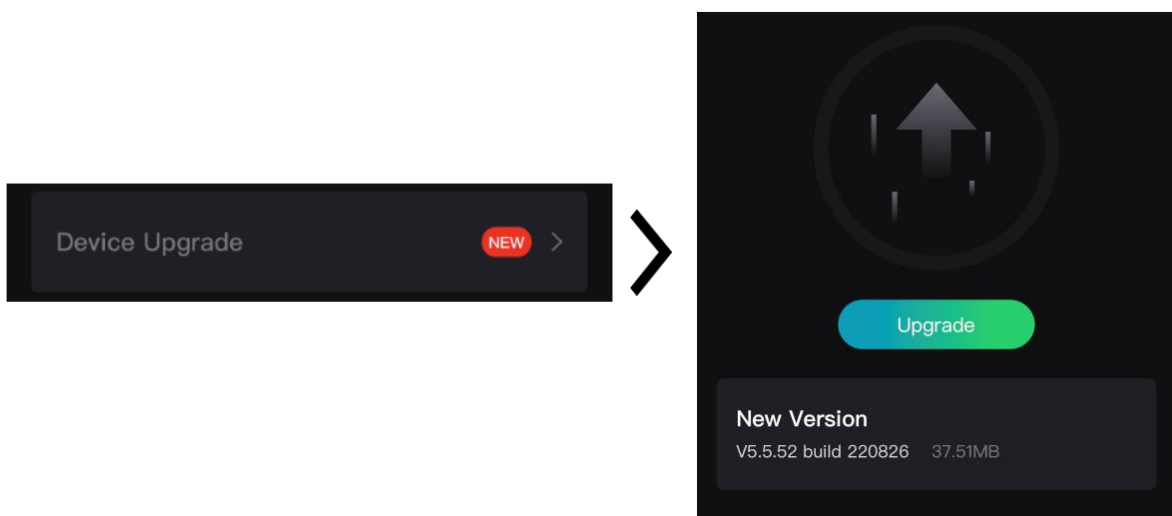

Figure 2-7 Upgrade Firmware

Note

The upgrading operation may vary due to app updates. Please take the actual app version for reference.

Upgrade Device via PC

Before You Start

- Please get the upgrade package (including Main Firmware and FPGA Firmware) first.
- Make sure the hotspot function is disabled.
- Remove batteries from the device before connecting to your PC.
- Turn on the device after connecting it to your PC, and keep the device on for 10 to 15 seconds before other operations.

Steps

1. Connect the device to your PC with cable, and then turn on the device.
2. Open the detected disk, copy the upgrade file and paste it to the root directory of the device.
3. Hold  to reboot the device, and the device upgrades automatically. The upgrading process will be displayed in the main interface.

Note

During the upgrade, make sure the device is connected to your PC. Otherwise, it may cause unnecessary upgrade failure, firmware damage, etc.

4. Repeat the above steps to upgrade all firmware one by one.

2.6 Zeroing

You can enable the reticle to view the position of the target. The functions such as freeze and zoom help to adjust the reticle more accurately. See **Zeroing** for detailed instructions.

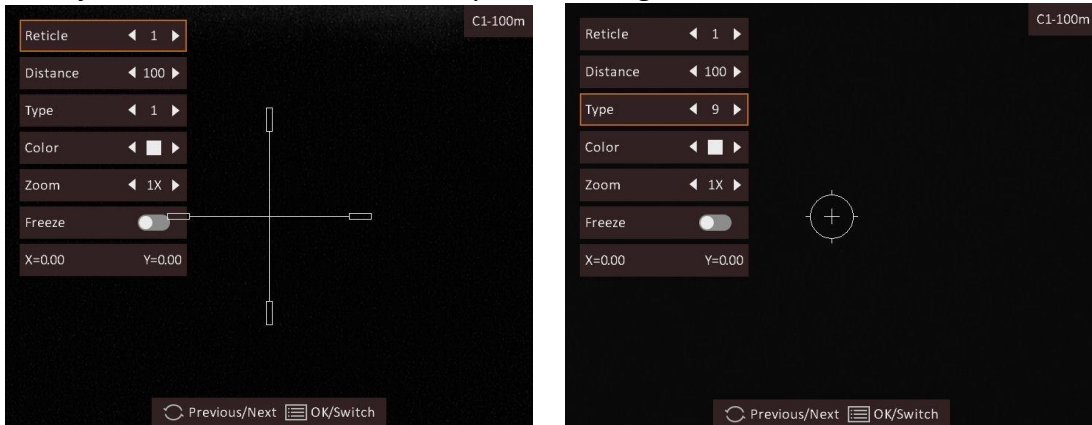

Figure 2-8 Zeroing

Chapter 3 Image Settings

3.1 Adjust Diopter

Steps

1. Power on the device.
2. Open the lens cover.
3. Hold the device and make sure the eyepiece covers your eye.
4. Adjust the focus ring until the OSD text or image is clear.

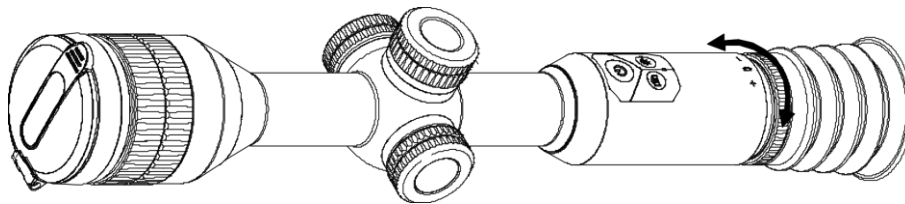

Figure 3-1 Adjust Diopter

Note

When adjusting diopter, DO NOT touch the surface of lens to avoid smearing the lens.

3.2 Adjust Focus

Steps

1. Power on the device.
2. Hold the device and make sure the eyepiece covers your eye.
3. Adjust the focus ring until the image is clear.

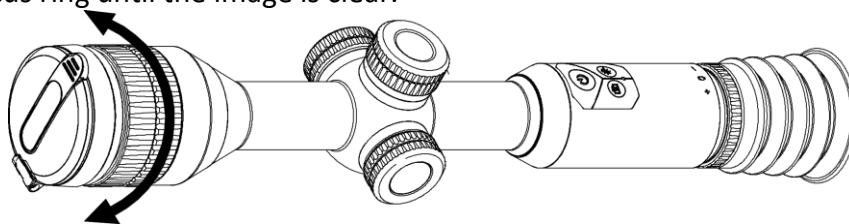

Figure 3-2 Adjust Focus

Note

When focusing, do not touch the surface of lens to avoid smearing the lens.

3.3 Adjust Brightness

In the menu mode, rotate the wheel to select  and press the wheel to adjust brightness. In white hot mode, the higher the value of brightness is, the brighter the image is. The image effect in white hot mode is showed as picture below and effect in black hot mode is opposite.



Figure 3-3 Adjust Brightness in White Hot Mode



3.4 Adjust Contrast

In the menu mode, rotate the wheel to select  and press the wheel to adjust image contrast.

3.5 Select Scene Mode

You can select proper scene mode according to actual using scene to improve the display effect.

Steps

1. Hold the wheel to go to the menu.
2. Rotate the wheel to select  and press the wheel to switch scene mode.
 -  refers to recognition mode and is recommended in normal scene.
 -  refers to jungle mode and is recommended in hunting environment.
3. Hold the wheel to save settings and exit.

3.6 Set Palettes

You can select different palettes to display the same scene in different effects. Press  in live view mode to switch palettes.

White Hot

The hot part is light-colored in view. The higher the temperature is, the lighter the color is.



Black Hot

The hot part is black-colored in view. The higher the temperature is, the darker the color is.



Red Hot

The hot part is red-colored in view. The higher the temperature is, the redder the color is.



Fusion

From high temperature to low temperature, the image is colored in from white, yellow, red, pink to purple.



3.7 Correct Defective Pixel

The device can correct the defective pixels on the screen.

Steps

1. Hold the wheel to show the menu.
2. Rotate the wheel to select , and press the wheel to enter the DPC setting interface.
3. In the DPC Interface, rotate the wheel to select **Axis**, and press the wheel to switch the moving direction of the cursor.
4. Rotate the wheel to move the cursor until it reaches the defective pixel, and press the wheel to confirm.
5. Rotate the wheel to select **DPC**, and press the wheel to correct the defective pixel.

Note

- The selected defective pixel can be magnified and displayed at the bottom right of the interface.

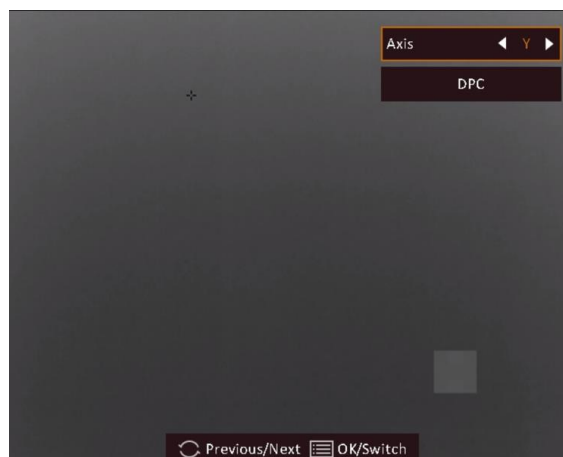

Figure 3-4 Correct Defective Pixel

- When the menu or OSD blocks the defective pixel, the menu at the bottom can be hidden,

and the menu at the upper left can be mirrored to the upper right of the interface.





Figure 3-5 Mirror Effect

3.8 Flat Field Correction

This function can correct non-uniformity of display.

Steps

1. Hold the wheel to enter the menu.
2. Rotate the wheel to select , and press the wheel to switch the FFC mode.
 - Manual FFC: In the live view mode, hold  to trigger calibration.
 - Auto FFC: The device performs FFC automatically according to the set schedule when switching on the camera.
 - External: In the live view mode, cover the lens cover and hold  to trigger calibration.
3. Hold the wheel to save and exit.

3.9 Set Picture in Picture Mode

Steps

1. In the live view mode, hold the wheel to show the menu.
2. Rotate the wheel to select , and press the wheel to enable or disable PIP mode. The details show in the upper center of the view.
3. Hold the wheel to save and exit.



Figure 3-6 Set Picture in Picture Mode

 **Note**

- When reticle is enabled, the PIP view is the detail of reticle. When reticle is not enabled, the PIP view is the detail of central part.
 - If the PIP function is enabled, the PIP view zooms when adjusting the digital zoom ratio.
-

3.10 Adjust Digital Zoom

In the live view mode, rotate the wheel to switch the digital zoom ratio of the device.

Steps

1. Hold the wheel to show the menu.
2. Rotate the wheel to select , and press the wheel to select a zoom mode.
 - **Continuous:** In the live view mode, rotate the wheel to zoom in or zoom out by 0.1× continuously.
 - **Multiple:** In the live view mode, rotate the wheel to set the digital zoom ratio to 1×, 2×, 4×, or 8×
3. Hold the wheel to save and exit.

Chapter 4 Zeroing

4.1 Select Reticle Group

If different users use the same device, the users can configure and save the reticle settings in their respective reticle group.

Steps

1. In the live view mode, hold the wheel to show the menu.
2. Rotate the wheel to select .
3. Press the wheel to switch the reticle group.
4. Hold the wheel to save and exit.

Result

The right top of the image displays the reticle information. For example, A2-100 m means you are using the No. 2 reticle in reticle group A, and the set range is 100 m.

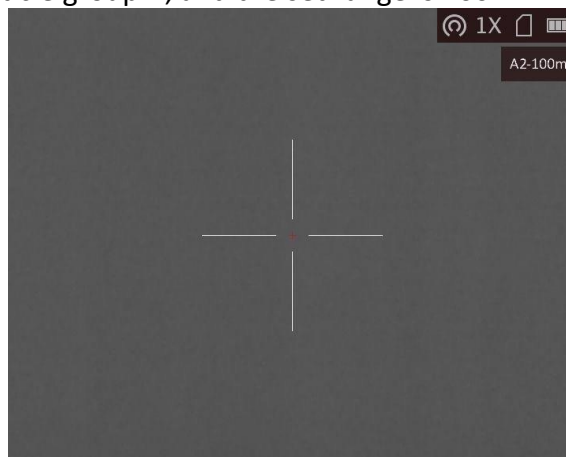



Figure 4-1 Using a Reticle

Note

- There are 5 reticle groups in total, and you can configure 5 reticles in each reticle group.
- You can press  and  at the same time to switch the reticles in the selected reticle group in the live view mode.

4.2 Set Reticle

You can select a reticle in the current reticle group, and set parameters such as type, color, and

position for the reticle.

Before You Start

Select a reticle group first.

Steps

1. In the live view mode, hold the wheel to show the menu.
2. Rotate the wheel to select , and press the wheel to enter the reticle setting interface.
3. Press the wheel to select a reticle No. You can select **OFF** to disable the reticle.
4. Set reticle type.
 - 1) In the reticle setting interface, rotate the wheel to select **Type**.
 - 2) Press the wheel to select a reticle type. 10 types of reticles can be selected.

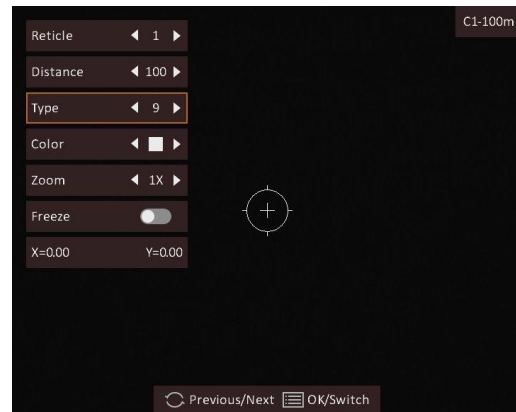
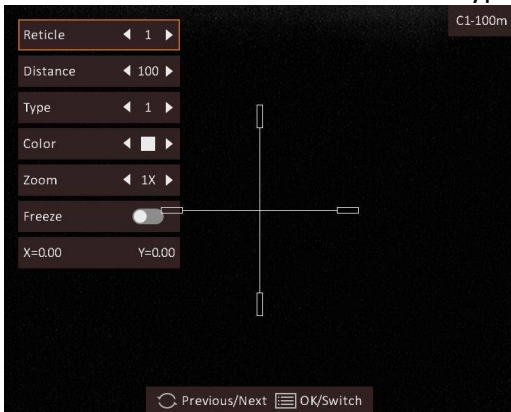

5. Set reticle color.
 - 1) Rotate the wheel to select **Color**.
 - 2) Press the wheel to switch the color of the reticle. **Black, White, Green, and Red** are selectable.
6. (Optional) Repeat 3 to 6 to set color for other reticles in this group.

Note

When you switch the reticle No., a prompt will appear on the interface. Select **OK** to save the parameters for the current reticle.

7. Hold the wheel to exit the interface according to the prompt.

- **OK:** Save the parameter and exit.
 - **CANCEL:** Exit and not save the parameters.
-

Note

- There are 5 reticles can be configured in a reticle group.
- If the PIP function is enabled, the aimed target can be magnified on the interface.

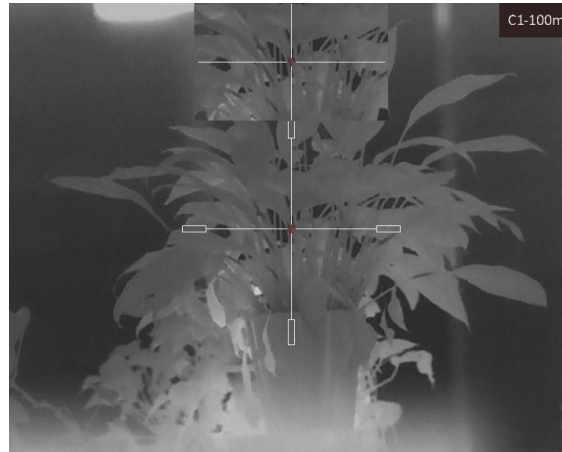

Figure 4-2 PIP Effect in Reticle Mode

- In black hot mode, if you set the reticle color as white, the reticle will display black automatically.

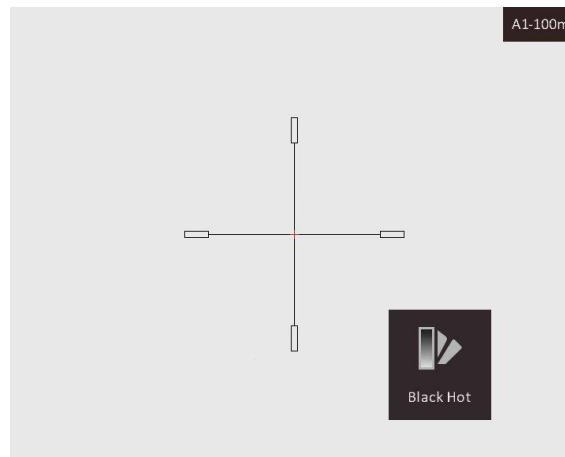

Figure 4-3 White Reticle in Black Hot Mode

4.3 Correct Reticle

Correcting the reticle can help you aim at the target with high accuracy by marking the offset between the big reticle and small reticle.

Before You Start

Select a reticle group first.

Steps

1. In the live view mode, hold the wheel to show the menu.
2. Rotate the wheel to select , and press the wheel to enter the reticle setting interface.
3. Press the wheel to select a reticle No. you want to correct.

4. Set the distance to the target.
 - 1) Rotate the wheel to select **Distance**.
 - 2) Press the wheel to select the number you want to change.
 - 3) Rotate the wheel to change the number.
 5. (Optional) Rotate the wheel to select **Freeze**, and press the wheel to enable the function.
-

Note

When enabling the freeze function in reticle, you can adjust the position of the cursor on a frozen image. This function can prevent image flutter.

6. Set the reticle position.
 - 1) Aim the big reticle at the target.
 - 2) (Optional) Rotate the wheel to select **Zoom**, and press the wheel to switch the zoom ratio.
 - 3) Rotate the wheel to select the coordinates, and press the wheel to switch the X and Y axis.
 - 4) Rotate the wheel to move the reticle until it reaches the target position. The small reticle indicates the initial position of the reticle.

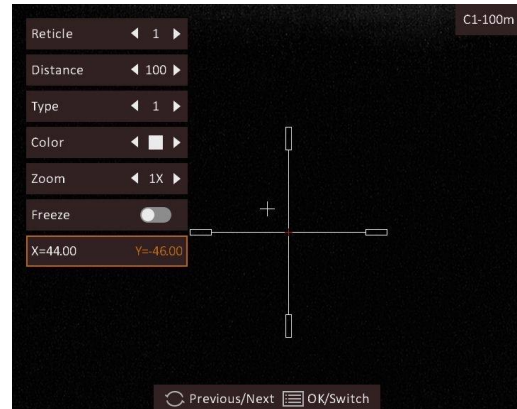
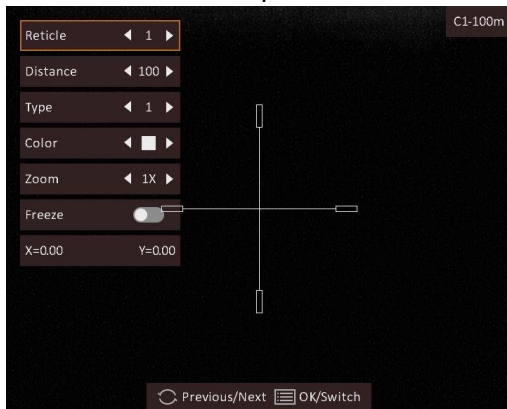

7. (Optional) Repeat 3 to 6 to set the position for other reticles in this group.
-

Note

When you switch the reticle No., a prompt will appear on the interface. Select **OK** to save the parameters for the current reticle.

7. Hold the wheel to exit the interface according to the prompt.
 - **OK**: Save the parameter and exit.
 - **CANCEL**: Exit but not save the parameters.

Chapter 5 Measure Distance

The device can detect the distance between the target and the observation position.

Before You Start

When measuring the distance, keep the hand and the position steady. Otherwise, the accuracy may be affected.

Steps

1. Hold the wheel to show the menu.
2. Rotate the wheel to select  and press the wheel to go to the setting interface.
3. Set the parameters for the target.
 - 1) Rotate the wheel to select the target from **Deer**, **Grey Wolf**, **Brown Bear**, and **Custom**.
 - 2) Press and rotate the wheel to set target height.

Note

The available height ranges from 0.1 m to 9.0 m.

- 3) Press the wheel to confirm.
- 4) Hold the wheel to save the settings and return to the distance measurement interface.
4. Align the center of top mark with the edge of target top, and press the wheel to confirm.
5. Align the center of bottom mark with the edge of target bottom, and press the wheel to confirm.

Result

The left top of the image displays the distance measurement result and the height of the target.



Figure 5-1 Measurement Result

Chapter 6 General Settings

You can manually record video or capture picture when displaying live view.

6.1 Set OSD

You can choose whether to display the OSD information on the live view mode.

Steps

1. Hold the wheel to show the menu.
2. Rotate the wheel to select , and press the wheel to enter the OSD setting interface.
3. Rotate the wheel to select the OSD information you want to display or not.
4. Press the wheel to enable or disable the selected OSD information.

6.2 Set Brand Logo

You can add brand logo on the live view mode.

Steps

1. Hold the wheel to show the menu.
2. Rotate the wheel to select .
3. Press the wheel to enable or disable **Brand Logo**.
4. Hold the wheel to save and exit.

Result

The brand logo is displayed at the bottom right of the image.

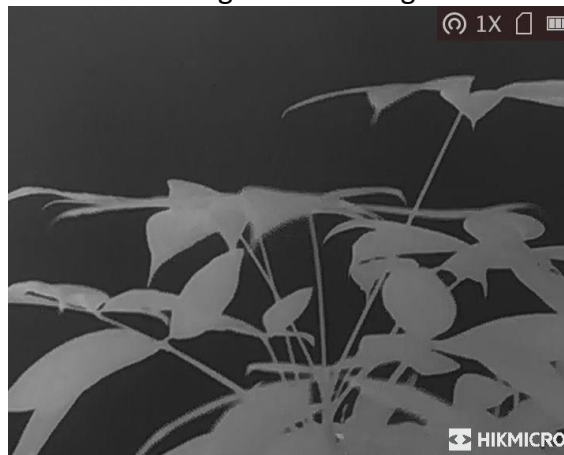



Figure 6-1 Brand Logo Display

Note

The brand logo is only displayed on the live view mode, captures and videos.

6.3 Burning Prevention

Steps

1. Hold the wheel to show the menu.
2. Rotate the wheel to select , and press the wheel to enable or disable the burn-prevention function.
3. Hold the wheel to save the settings and exit.

Note

Avoid direct sunlight and enable the Burning Prevention function to reduce the risk of sensor damage from the heat.

6.4 Capture and Video

6.4.1 Capture Picture

Steps

1. In the live view mode, hold the wheel to show the menu.
2. Rotate the wheel to select , and press the wheel to capture a picture.
3. Hold the wheel to exit.

Note

When capturing succeeds, the image freezes for 1 second and a prompt shows on the display. For exporting captured pictures, refer to **Export Files**.

6.4.2 Set Audio

If you enable the audio function, the sound will be recorded with the video. When there is too loud noise in the video, you can disable this function.

Steps

1. In the live view mode, hold the wheel to show the menu.
2. Rotate the wheel to select .
3. Press the wheel to enable or disable this function.
4. Hold the wheel to save and exit.

6.4.3 Record Video

Steps



1. In the live view mode, hold  and start recording.



Figure 6-2 Start Recording

The left top of image displays the information of recording time.

2. Hold  again to stop recording.

What to do next

For exporting recording files, refer to **Export Files**.

6.4.4 Prerecord Video

After enabling this function, the device can automatically record the 7 seconds before and after the recoil-activation.

Steps

1. In the live view mode, hold the wheel to show the menu.
2. Rotate the wheel to select .
3. Press the wheel to switch the on/off mode this function.
4. Hold the wheel to save and exit.

Note

If you activate recoils continuously, the device will record the 7 seconds before the first recoil until the 7 seconds after the last recoil.

What to do next

For exporting recording files, refer to **Export Files**.

6.5 Hot Tracking

The device can detect the highest temperature spot in the scene and mark it on display.

Steps

1. Hold the wheel to show the menu.
2. Rotate the wheel to select , and press the wheel to mark the spot of highest temperature.
3. Hold the wheel to save the settings and exit.

Result



When the function is enabled,  displays in the spot of highest temperature. When the scene changes, the  moves accordingly.



Figure 6-3 Hot Tracking

6.6 Export Files

This function is used to export recorded videos and captured pictures.

Before You Start

- Turn off hotspot function.
- Turn on the device after connecting it to your PC, and keep the device on for 10 to 15 seconds before other operations.
- Remove batteries from the device before connecting to your PC, or it may cause device damage.

Steps

1. Connect the device and PC with a Type-C cable.

Note

Make sure the device is turned on when connecting the cable.

2. Open computer disk and select the disk of device. Go to the **DCIM** folder and find the folder named after the capture year and month. For example, if you capture a picture or record a video in June 2022, go to **DCIM → 202206** to find the picture or video.
 3. Select and copy the files to PC.
 4. Disconnect the device from your PC.
-

Note

- The device displays images when you connect it to PC, but functions such as recording, capturing and hotspot are disabled.
 - When you connect the device to PC for the first time, it installs the drive program automatically.
 - You can also export files via HIKMICRO Sight. See the user manual of the app for detailed operation.
-

Chapter 7 System Settings

7.1 Synchronize Time

Steps

1. Hold the wheel to show the menu.
2. Rotate the wheel to select , and press the wheel to enter the time setting interface.
3. Press the wheel to switch the time system, and rotate the wheel to select the time and date to be synchronized.
4. Press the wheel to select the hour, minute, second, year, month, or day to be synchronized.
5. Rotate the wheel to change the hour, minute, second, year, month, or day selected, and press the wheel again to finish the setting.
6. Hold the wheel to save and exit.

7.2 Language Settings

You can select the device language in this function.

Steps

1. Hold the wheel to show the menu.
2. Rotate the wheel to select , and press the wheel to enter the language configuration interface.
3. Rotate the wheel to select the language as required, and press the wheel to confirm.

7.3 Unit Settings

You can switch the unit for fusion level and distance measurement functions.

Steps

1. Hold the wheel to show the menu.
2. Rotate the wheel to select , and press the wheel to switch the unit. **Yard** and **m** (meter) are selectable.
3. Hold the wheel to save settings and exit.

7.4 View Device Information

Steps

1. Hold the wheel to show the menu of device.

2. Select , and press the wheel. You can view the device information such as version, and serial No.

7.5 Restore Device

Steps

1. Hold the wheel to show the menu of device.
2. Rotate the wheel to select , and press the wheel to restore the device to defaults according to the prompt.

Chapter 8 Frequently Asked Questions

8.1 Why is the monitor off?

Check whether the device is off-battery. Check the monitor after charging the device for 5 minutes.

8.2 The image is not clear, how to adjust it?

Adjust the diopter adjustment knob until the image is clear. Refer to section Adjust Diopter.

8.3 Capturing or recording fails. What's the problem?

Check the following items.

- Whether the device is connected to your PC. Capturing or recording is disabled in this status.
- Whether the storage space is full.
- Whether the device is low-battery.

8.4 Why the PC cannot identify the device?

Check the following items.

- Whether the device is connected to your PC with supplied USB cable.
- If you use other USB cables, make sure the cable length is no longer than 1 m.
- Whether the hotspot function is turned on. If so, go to device menu and turn off hotspot.

Chapter 9 Appendix

9.1 Device Command

Scan the following QR code to get device common serial port commands.

Note that the command list contains the commonly used serial port commands for HIKMICRO thermal cameras.



9.2 Device Communication Matrix

Scan the following QR code to get device communication matrix.

Note that the matrix contains all communication ports of HIKMICRO thermal cameras.



Safety Instruction



These instructions are intended to ensure that user can use the product correctly to avoid danger or property loss.

Laws and Regulations

- Use of the product must be in strict compliance with the local electrical safety regulations.

Symbol Conventions

The symbols that may be found in this document are defined as follows.

Symbol	Description
 Danger	Indicates a hazardous situation which, if not avoided, will or could result in death or serious injury.
 Caution	Indicates a potentially hazardous situation which, if not avoided, could result in equipment damage, data loss, performance degradation, or unexpected results.
 Note	Provides additional information to emphasize or supplement important points of the main text.

Transportation

- Keep the device in original or similar packaging while transporting it.
- Keep all wrappers after unpacking them for future use. In case of any failure occurred, you need to return the device to the factory with the original wrapper. Transportation without the original wrapper may result in damage on the device and the company shall not take any responsibilities.
- DO NOT drop the product or subject it to physical shock. Keep the device away from magnetic interference.

Power Supply

- Please purchase the charger by yourself. Input voltage should meet the Limited Power Source (5 VDC, 2A) according to the IEC61010-1 standard. Please refer to technical specifications for detailed information.
- Use the power adapter provided by qualified manufacturer. Refer to the product specification for detailed power requirements.
- Make sure the plug is properly connected to the power socket.
- DO NOT connect multiple devices to one power adapter, to avoid over-heating or fire hazards caused by overload.

Battery

- Improper use or replacement of the battery may result in explosion hazard. Replace with the same or equivalent type only.
- The built-in battery type is 18650 with the protection board, and the battery size should be 23 mm × 67 mm. The rated voltage and capacity are 3.6 VDC/3350 mAh (12.18 Wh).
- The external removable battery type is CR123A, and the max. rated voltage and capacity are 3

VDC/2 A and 1600 mAh. Dispose of used batteries in conformance with the instructions provided by the battery manufacturer.

- Use the battery provided by a qualified manufacturer. Refer to the product specification for detailed battery requirements.
- Make sure the battery temperature is between 0°C to 45 °C (32 °F to 113 °F) when charging.
- Install the external battery before the built-in battery runs out, or the device cannot be turned on.
- Confirm there is no flammable material within 2 m of the charger during charging.
- DO NOT place the battery near heating or fire source. Avoid direct sunlight.
- DO NOT place the battery in the reach of children.

Maintenance

- If the product does not work properly, please contact your dealer or the nearest service center. We shall not assume any responsibility for problems caused by unauthorized repair or maintenance.
- Wipe the device gently with a clean cloth and a small quantity of ethanol, if necessary.
- If the equipment is used in a manner not specified by the manufacturer, the protection provided by the device may be impaired.
- It is recommended to reboot the device every 2 hours when using it to ensure the device performance.

Using Environment

- Make sure the running environment meets the requirement of the device. The operating temperature shall be between -30 °C to 55 °C (-22 °F to 131 °F), and humidity shall be 5% to 95%.
- DO NOT expose the device to high electromagnetic radiation or dusty environments.
- DO NOT aim the lens at the sun or any other bright light.
- Place the device in a dry and well-ventilated environment.
- When any laser equipment is in use, make sure that the device lens is not exposed to the laser beam, or it may burn out.

Emergency

- If smoke, odor, or noise arises from the device, immediately turn off the power, unplug the power cable, and contact the service center.

Manufacture Address

Room 313, Unit B, Building 2, 399 Danfeng Road, Xixing Subdistrict, Binjiang District, Hangzhou, Zhejiang 310052, China
Hangzhou Microimage Software Co., Ltd.

COMPLIANCE NOTICE: The thermal series products might be subject to export controls in various countries or regions, including without limitation, the United States, European Union, United Kingdom and/or other member countries of the Wassenaar Arrangement. Please consult your professional legal or compliance expert or local government authorities for any necessary export license requirements if you intend to transfer, export, re-export the thermal series products between different countries.

Legal Information

©2022 Hangzhou Microimage Software Co., Ltd. All rights reserved.

About this Manual

The Manual includes instructions for using and managing the Product. Pictures, charts, images and all other information hereinafter are for description and explanation only. The information contained in the Manual is subject to change, without notice, due to firmware updates or other reasons. Please find the latest version of this Manual at the HIKMICRO website (www.hikmicrotech.com/).

Please use this Manual with the guidance and assistance of professionals trained in supporting the Product.

Trademarks Acknowledgement

 **HIKMICRO** and other HIKMICRO's trademarks and logos are the properties of HIKMICRO in various jurisdictions.

Other trademarks and logos mentioned are the properties of their respective owners.

LEGAL DISCLAIMER

TO THE MAXIMUM EXTENT PERMITTED BY APPLICABLE LAW, THIS MANUAL AND THE PRODUCT DESCRIBED, WITH ITS HARDWARE, SOFTWARE AND FIRMWARE, ARE PROVIDED "AS IS" AND "WITH ALL FAULTS AND ERRORS". HIKMICRO MAKES NO WARRANTIES, EXPRESS OR IMPLIED, INCLUDING WITHOUT LIMITATION, MERCHANTABILITY, SATISFACTORY QUALITY, OR FITNESS FOR A PARTICULAR PURPOSE. THE USE OF THE PRODUCT BY YOU IS AT YOUR OWN RISK. IN NO EVENT WILL HIKMICRO BE LIABLE TO YOU FOR ANY SPECIAL, CONSEQUENTIAL, INCIDENTAL, OR INDIRECT DAMAGES, INCLUDING, AMONG OTHERS, DAMAGES FOR LOSS OF BUSINESS PROFITS, BUSINESS INTERRUPTION, OR LOSS OF DATA, CORRUPTION OF SYSTEMS, OR LOSS OF DOCUMENTATION, WHETHER BASED ON BREACH OF CONTRACT, TORT (INCLUDING NEGLIGENCE), PRODUCT LIABILITY, OR OTHERWISE, IN CONNECTION WITH THE USE OF THE PRODUCT, EVEN IF HIKMICRO HAS BEEN ADVISED OF THE POSSIBILITY OF SUCH DAMAGES OR LOSS.

YOU ACKNOWLEDGE THAT THE NATURE OF THE INTERNET PROVIDES FOR INHERENT SECURITY RISKS, AND HIKMICRO SHALL NOT TAKE ANY RESPONSIBILITIES FOR ABNORMAL OPERATION, PRIVACY LEAKAGE OR OTHER DAMAGES RESULTING FROM CYBER-ATTACK, HACKER ATTACK, VIRUS INFECTION, OR OTHER INTERNET SECURITY RISKS; HOWEVER, HIKMICRO WILL PROVIDE TIMELY TECHNICAL SUPPORT IF REQUIRED.

YOU AGREE TO USE THIS PRODUCT IN COMPLIANCE WITH ALL APPLICABLE LAWS, AND YOU ARE SOLELY RESPONSIBLE FOR ENSURING THAT YOUR USE CONFORMS TO THE APPLICABLE LAW. ESPECIALLY, YOU ARE RESPONSIBLE, FOR USING THIS PRODUCT IN A MANNER THAT DOES NOT INFRINGE ON THE RIGHTS OF THIRD PARTIES, INCLUDING WITHOUT LIMITATION, RIGHTS OF PUBLICITY, INTELLECTUAL PROPERTY RIGHTS, OR DATA PROTECTION AND OTHER PRIVACY RIGHTS. YOU SHALL NOT USE THIS PRODUCT FOR ILLEGAL HUNTING ANIMALS, INVASION OF PRIVACY OR ANY OTHER PURPOSE WHICH IS ILLEGAL OR DETRIMENTAL TO THE PUBLIC INTEREST. YOU SHALL NOT USE THIS PRODUCT FOR ANY PROHIBITED END-USES, INCLUDING THE DEVELOPMENT OR PRODUCTION OF WEAPONS OF MASS DESTRUCTION, THE DEVELOPMENT OR PRODUCTION OF CHEMICAL OR BIOLOGICAL WEAPONS, ANY ACTIVITIES IN THE CONTEXT RELATED TO ANY NUCLEAR EXPLOSIVE OR UNSAFE NUCLEAR FUEL-CYCLE, OR IN SUPPORT OF HUMAN RIGHTS ABUSES.

IN THE EVENT OF ANY CONFLICTS BETWEEN THIS MANUAL AND THE APPLICABLE LAW, THE LATTER PREVAILS.

Regulatory Information

These clauses apply only to the products bearing the corresponding mark or information.

FCC Information

Note: This product has been tested and found to comply with the limits for a Class B digital device, pursuant to Part 15 of the FCC Rules. These limits are designed to provide reasonable protection against harmful interference in a residential installation. This product generates, uses, and can radiate radio frequency energy and, if not installed and used in accordance with the instructions, may cause harmful interference to radio communications. However, there is no guarantee that interference will not occur in a particular installation. If this product does cause harmful interference to radio or television reception, which can be determined by turning the equipment off and on, the user is encouraged to try to correct the interference by one or more of the following measures:

- Reorient or relocate the receiving antenna.
- Increase the separation between the equipment and receiver.
- Connect the equipment into an outlet on a circuit different from that to which the receiver is connected.
- Consult the dealer or an experienced radio/TV technician for help.

Please take attention that changes or modification not expressly approved by the party responsible for compliance could void the user's authority to operate the equipment.

This device complies with Part 15 of the FCC Rules. Operation is subject to the following two conditions:

- (1) This device may not cause harmful interference, and
- (2) This device must accept any interference received, including interference that may cause undesired operation.

This equipment complies with FCC radiation exposure limits set forth for an uncontrolled environment.

Note: Due to the device size limit, the above statement may not be disclaimed on the device.

EU Conformity Statement



This product and - if applicable - the supplied accessories too are marked with "CE" and comply therefore with the applicable harmonized European standards listed under the Directive 2014/30/EU (EMCD), Directive 2014/35/EU (LVD), Directive 2011/65/EU (RoHS).



This product and - if applicable - the supplied accessories too are marked with "UKCA" and comply therefore with the following directives: Radio Equipment Regulations 2017, Electromagnetic Compatibility Regulations 2016, Electrical Equipment (Safety) Regulations 2016, the Restriction of the Use of Certain Hazardous Substances in Electrical and Electronic Equipment Regulations 2012.



Directive 2012/19/EU (WEEE Directive): Products marked with this symbol cannot be disposed of as unsorted municipal waste in the European Union. For proper recycling, return this product to your local supplier upon the purchase of equivalent new equipment, or dispose of it at designated collection points. For more information see: www.recyclethis.info.

According to the Waste Electrical and Electronic Equipment Regulations 2013: Products marked with this symbol cannot be disposed of as unsorted municipal waste in the United Kingdom. For proper recycling, return this product to your local supplier upon the purchase of equivalent new equipment, or dispose of it at designated collection points. For more information see: www.recyclethis.info.



Directive 2006/66/EC and its amendment 2013/56/EU (Battery Directive): This product contains a battery that cannot be disposed of as unsorted municipal waste in the European Union. See the product documentation for specific battery information. The battery is marked with this symbol, which may include lettering to indicate cadmium (Cd), lead (Pb), or mercury (Hg). For proper recycling, return the battery to your supplier or to a designated collection point. For more information see: www.recyclethis.info.

According to the Batteries and Accumulators (Placing on the Market) Regulations 2008 and the Waste Batteries and Accumulators Regulations 2009: This product contains a battery that cannot be disposed of as unsorted municipal waste in the United Kingdom. See the product documentation for specific battery information. The battery is marked with this symbol, which may include lettering to indicate cadmium (Cd), lead (Pb), or mercury (Hg). For proper recycling, return the battery to your supplier or to a designated collection point. For more information see: www.recyclethis.info.

Use the power adapter provided by a qualified manufacturer. Refer to the product specification for detailed power requirements.

Use the battery provided by a qualified manufacturer. Refer to the product specification for detailed battery requirements.

Industry Canada ICES-003 Compliance

This device meets the CAN ICES-003 (B) / NMB-003 (B) standards requirements.

This device complies with Industry Canada license-exempt RSS standard(s). Operation is subject to the following two conditions:

- (1) this device may not cause interference, and
- (2) this device must accept any interference, including interference that may cause undesired operation of the device.

Le présent appareil est conforme aux CNR d'Industrie Canada applicables aux appareils radioexempts de licence. L'exploitation est autorisée aux deux conditions suivantes:

- (1) l'appareil ne doit pas produire de brouillage, et

(2) l'utilisateur de l'appareil doit accepter tout brouillage radioélectrique subi, même si le brouillage est susceptible d'en compromettre le fonctionnement.

This equipment complies with IC RSS-102 radiation exposure limits set forth for an uncontrolled environment.

ce matériel est conforme aux limites de dose d'exposition aux rayonnements, CNR-102 énoncée dans un autre environnement.

KC

B급 기기: 이 기기는 가정용(B급) 전자파적합기기로서 주로 가정에서 사용하는 것을 목적으로 하며, 모든 지역에서 사용할 수 있습니다.



HIKMICRO

See the World in a New Way



Facebook: HIKMICRO Outdoor Instagram: hikmicro_outdoor

YouTube: HIKMICRO Outdoor

LinkedIn: HIKMICRO

Website: www.hikmicrotech.com

E-mail: support@hikmicrotech.com