



Handheld Acoustic Imaging Camera

User Manual



Contact Us

Safety Instruction

These instructions are intended to ensure that user can use the product correctly to avoid danger or property loss.

Laws and Regulations

- Use of the product must be in strict compliance with the local electrical safety regulations.

Transportation

- Keep the device in original or similar packaging while transporting it.
- Keep all wrappers after unpacking them for future use. In case of any failure occurred, you need to return the device to the factory with the original wrapper. Transportation without the original wrapper may result in damage on the device and the company shall not take any responsibilities.
- DO NOT drop the product or subject it to physical shock. Keep the device away from magnetic interference.

Power Supply

- Please purchase the charger by yourself. Input voltage should meet the Limited Power Source (5 VDC, 2 A) according to the IEC61010-1 standard. Please refer to technical specifications for detailed information.
- Make sure the plug is properly connected to the power socket.
- DO NOT connect multiple devices to one power adapter, to avoid over-heating or fire hazards caused by overload.

Battery

- Improper use or replacement of the battery may result in explosion hazard. Replace with the same or equivalent type only. Dispose of used batteries in conformance with the instructions provided by the battery manufacturer.
- The built-in battery cannot be dismantled. Please contact the manufacture for repair if necessary.
- For long-term storage of the battery, make sure it is fully charged every half year to ensure the battery quality. Otherwise, damage may occur.

- DO NOT charge other battery types with the supplied charger. Confirm there is no flammable material within 2 m of the charger during charging.
- DO NOT place the battery near heating or fire source. Avoid direct sunlight.
- DO NOT swallow the battery to avoid chemical burns.
- DO NOT place the battery in the reach of children.
- The lithium battery voltage is 3.6 V, and the battery capacity is 6230 mAh (22.43 Wh).
- The battery is certified by UL2054.

Maintenance

- If the product does not work properly, please contact your dealer or the nearest service center. We shall not assume any responsibility for problems caused by unauthorized repair or maintenance.
- A few device components (e.g., electrolytic capacitor) require regular replacement. The average lifespan varies, so periodic checking is recommended. Contact your dealer for details.
- Wipe the device gently with a clean cloth and a small quantity of ethanol, if necessary.
- If the equipment is used in a manner not specified by the manufacturer, the protection provided by the device may be impaired.
- We recommend you send the device back for calibration once a year, and please contact the local dealer for the information on maintenance points.
- Please notice that the current limit of USB 3.0 PowerShare port may vary with the PC brand, which is likely to result in incompatibility issue. Therefore it's advised to use regular USB 3.0 or USB 2.0 port if the USB device fails to be recognized by PC via USB 3.0 PowerShare port.

Using Environment

- Make sure the running environment meets the requirement of the device. The operating temperature shall be -20 °C to 50 °C (-4 °F to 122 °F), and the operating humidity shall be 90% or less.
- DO NOT expose the device to high electromagnetic radiation or dusty environments.
- DO NOT aim the lens at the sun or any other bright light.

Technical Support

The <https://www.hikmicrotech.com/en/contact-us.html> portal will help you as a HIKMICRO customer to get the most out of your HIKMICRO products. The portal gives you access to our support team, software and documentation, service contacts, etc.

Emergency

If smoke, odor, or noise arises from the device, immediately turn off the power, unplug the power cable, and contact the service center.



Manufacture Address

Room 313, Unit B, Building 2, 399 Danfeng Road, Xixing Subdistrict, Binjiang District, Hangzhou, Zhejiang 310052, China

Hangzhou Microimage Software Co., Ltd

Symbol Conventions

The symbols that may be found in this document are defined as follows.

Symbol	Description
 Danger	Indicates a hazardous situation which, if not avoided, will or could result in death or serious injury.
 Caution	Indicates a potentially hazardous situation which, if not avoided, could result in equipment damage, data loss, performance degradation, or unexpected results.
 Note	Provides additional information to emphasize or supplement important points of the main text.

Contents

1	Overview	1
1.1	Device Description.....	1
1.2	Main Function.....	1
1.3	Appearance.....	2
2	Preparation	7
2.1	Mount Hand Strap.....	7
2.2	Operation Method.....	8
2.3	Charge Device.....	9
2.3.1	Charge Device via Cable Interface.....	9
2.3.2	Charge Device via Charging Base.....	10
2.4	Power On/Off.....	11
2.4.1	Set Auto Power-off Countdown.....	11
2.5	Sleep and Wake.....	12
2.6	Live Interface and Menu.....	12
2.6.1	Live View Interface.....	12
2.6.2	Menus.....	15
3	Acoustic Wave Detection	17
3.1	Set Detection Mode.....	17
3.1.2	Partial Discharge Types and Levels.....	17
3.1.3	Gas Leakage Estimation.....	20
3.2	Set Frequency.....	21
3.2.1	Switch among Pre-defined Target Frequency Ranges.....	22
3.2.2	Set Target Frequency Range Manually.....	22
3.3	Set Acoustic Palettes.....	23
3.3.1	Set Palette Color.....	23
3.3.2	Set Palette Opacity.....	24
3.3.3	Set Intensity Range for Palettes.....	24
3.4	Set Sound Source Distance.....	25
3.5	Set Detection Sensitivity.....	25
3.6	More Tools.....	26
3.6.1	Mark and Display Peak Intensity.....	26
3.6.2	Regional Detection Frame.....	26
3.6.3	Show Multiple Sound Sources.....	27
4	Display Settings	28
4.1	Set Screen Brightness.....	28
4.2	Adjust Digital Zoom.....	28
4.3	Display OSD Info.....	29
4.4	Set Grayscale of Visual Image.....	29
5	Picture and Video	30
5.1	Capture Picture.....	30
5.2	Record Video.....	31
5.3	View and Manage Local Files.....	32

Handheld Acoustic Imaging Camera User Manual

5.3.2	Manage Albums.....	32
5.3.3	Manage Files.....	33
5.3.4	Edit Files.....	34
5.4	Export Files.....	35
5.5	Analyze Snapshot via HIKMICRO Analyzer Acoustic	36
6	Connect	37
6.1	Connect Device to Wi-Fi	37
6.2	Set Device Hotspot	38
6.3	Pair Bluetooth Devices	39
7	Maintenance	40
7.1	View Device Information	40
7.2	Set Language	40
7.3	Set Time and Date	40
7.4	Upgrade Device.....	40
7.5	Restore Device.....	41
8	FAQ	42

1 Overview

1.1 Device Description

The HIKMIRCO acoustic imaging camera is a professional product for sound source localization. With its Low-noise MEMS microphones and adjustable bandwidth range, it provides an easy and effective way to locate the pressurized air leaks or partial discharge in industrial environments. By using a large 4.3" LCD touch screen, the results overlaying on a visual image allows you to quickly find the source of the problems. Adopting this lightweight and easy-to-use tool, you can discover the potential safety risks, minimize troubleshooting, and save extra costs of equipment failures and downtime.

1.2 Main Function

Acoustic Imaging

Device detects the real-time sound intensity of the sources, and locates the sources in the scene.

Partial Discharge Detection (PD)

Device detects partial discharge activities and estimate their types based on sound frequency, and displays the real-time estimation in live view for your reference.

Gas Leakage Detection (LD)

Device detects and estimates real-time gas leak rate, leak cost, and leak level for reference.

Palette

Device supports multiple palettes to display the detected sound sources and their intensities.

Record Videos & Capture Snapshots

Device supports recording videos, capturing snapshots, and managing albums.

1.3 Appearance

There are two types of the acoustic imaging camera in this series with different microphone array.

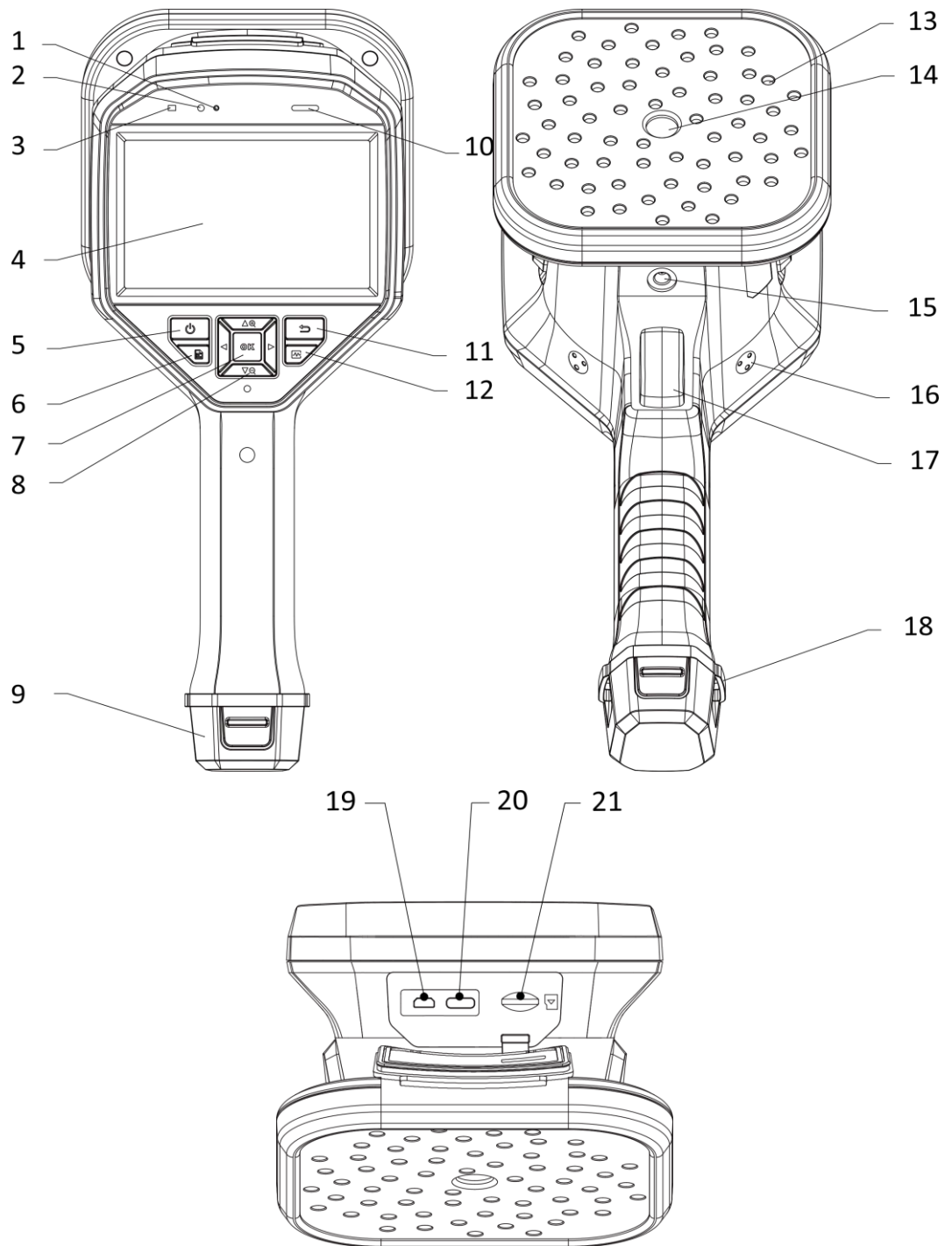

Figure 1-1 Appearance: 64-Microphone Array

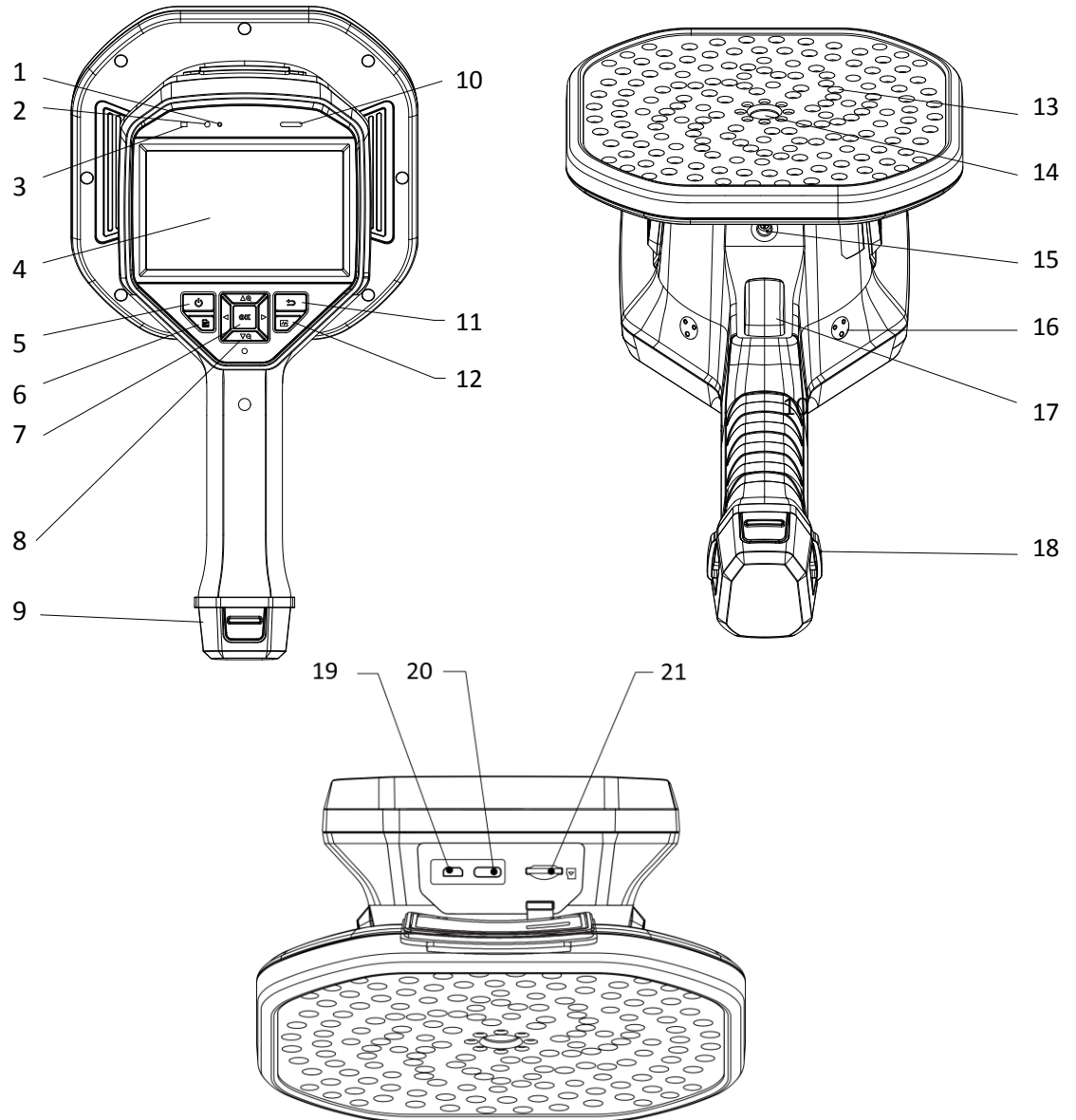















Figure 1-2 Appearance: 136-Microphone Array

Table 1-1 Interface Description

No.	Component	Function
1	Light Sensor	Senses the ambient brightness.
2	Microphone	Records voice remarks.
3	Power Indicator	Solid red: Charge normally. Solid green: Fully charged.
4	LCD Touch Screen	Allows live view and touch-screen operation.

Handheld Acoustic Imaging Camera User Manual

5	Power Button	Hold  to power on/off.
6	File Button	Press  to access the albums.
7	Confirm Button	Non-Menu Mode: Press  to enter menu. Menu Mode: Press  to confirm.
8	Navigation Button	Non-Menu Mode: <ul style="list-style-type: none"> ● Press  or  to zoom in or zoom out by 0.1x continuously. ● Hold  or  to zoom in or zoom out by 1x continuously. Menu Mode: Press  ,  ,  , and  to select parameters.
9	Battery Compartment	For holding the battery.
10	Loudspeaker	Plays voice remarks.
11	Back Button	Press  to save the parameters and return to previous menu.
12	Frequency Button	Press to select the frequency range frame edges and configure the frequency parameters.
13	Microphone Array	Detects sound in the scene.
14	Visual Camera	Views the visual images.
15	Tripod Attachment Point	Mounts the tripod.
16	Hand Strap Attachment Points	Mounts the hand strap.
17	Trigger	Non-Menu Mode: <ul style="list-style-type: none"> ● Press: Capture snapshots. ● Hold: Record videos. Menu Mode: Press to return to live view interface.

Handheld Acoustic Imaging Camera User Manual

18	Hand Strap Attachment Holes	Fixes the lower part of the hand strap to the device.
19	Micro HDMI Interface	Displays the image and menu interface via HDMI output.
20	Type-C Interface	Charges the device or exports files with supplied cable.
21	MicroSD Card Slot	For holding the MicroSD card.

2 Preparation

2.1 Mount Hand Strap

The hand straps aim at attaching to the device and stabilizing it. Please make sure wrap your hands with the hand straps to prevent the device from accidental falling or bumping.

The upper part of the hand strap is attached to the camera by a buckle. There are two buckle attachment points on both sides of the device. The lower part of the hand strap is threaded through the holes at the base of the device.

1. Insert the upper part of the hand straps into the buckles.

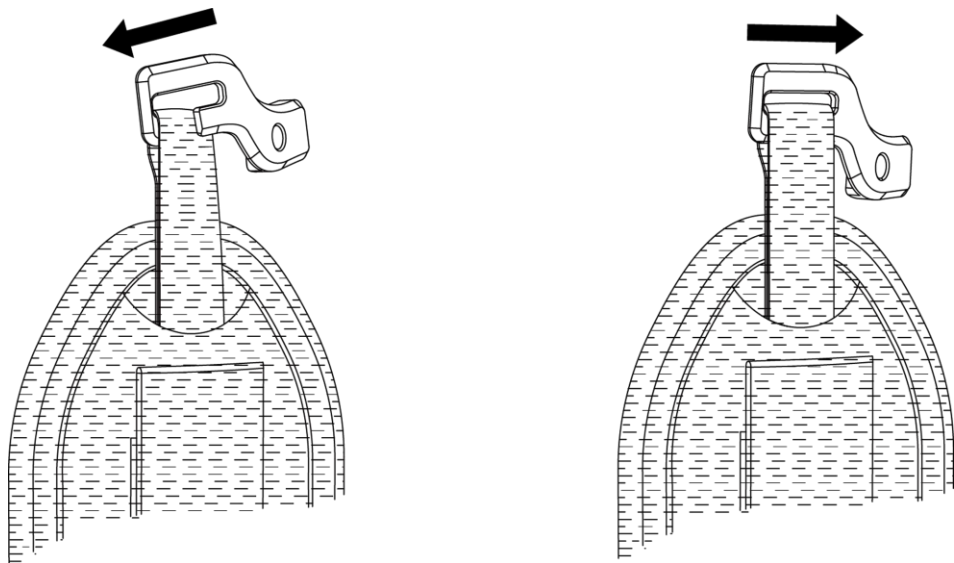

Figure 2-1 Insert Upper Part of Hand Strap

2. Fit the buckle on the device and tighten the screw with the supplied wrench.
3. Thread the lower part of the hand strap through the hole at the base of the device.
4. Secure the hand strap with the hook-and-loop fastener. Adjust the tightness according to your hands.

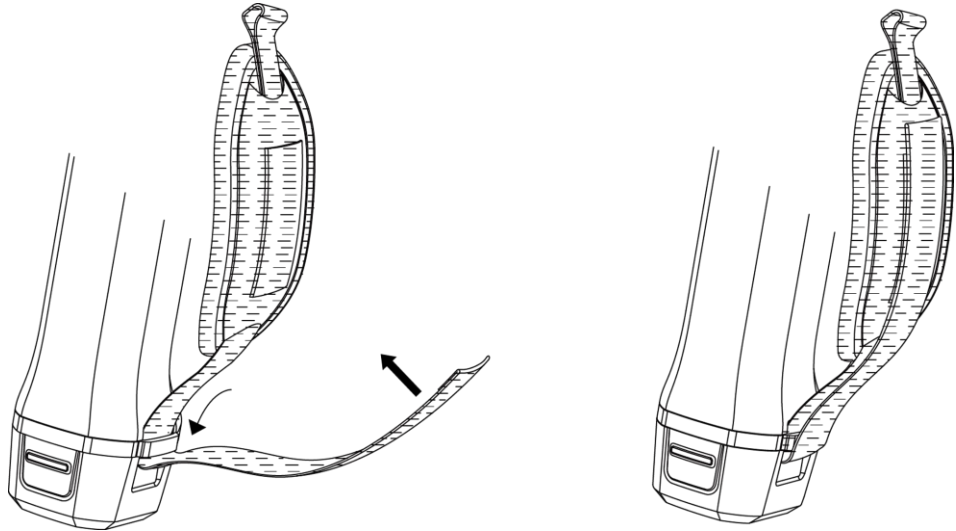

Figure 2-2 Secure Lower Part of Hand Strap

2.2 Operation Method

The device supports both touch-screen control and button control.

Touch-Screen Control

Tap on the screen to set parameters and configurations.

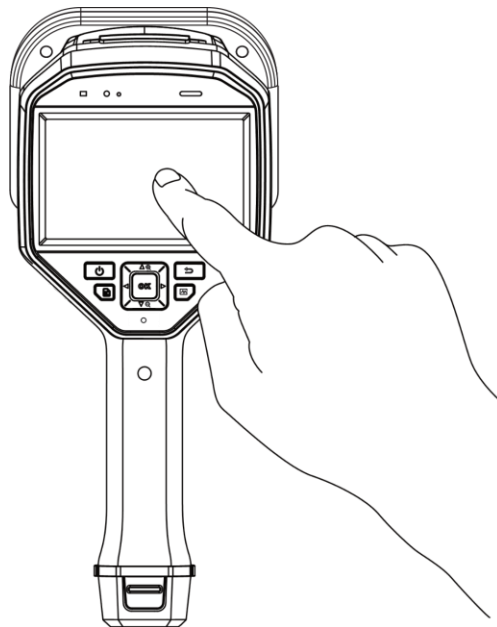

Figure 2-3 Touch-Screen Control

Button Control

Press the navigation buttons to set parameters and configurations.

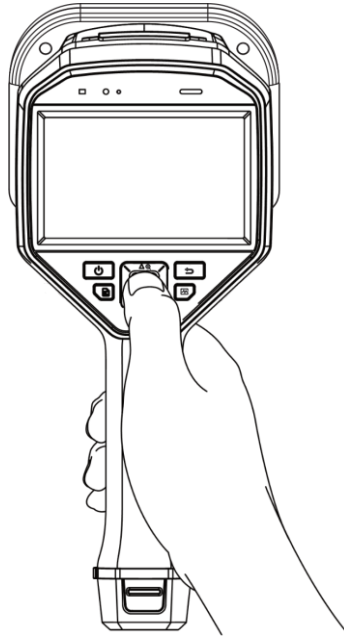

Figure 2-4 Button Control

2.3 Charge Device

Please fully charge the device before it is used for the first time or when it is in low battery.

2.3.1 Charge Device via Cable Interface

Before You Start

Please make sure the battery is installed before charging via cables.

Steps

1. Open the connector cover of the device.
2. Plug the type-C male connector of the charging cable to the device and the other type-A connector to power adapter.

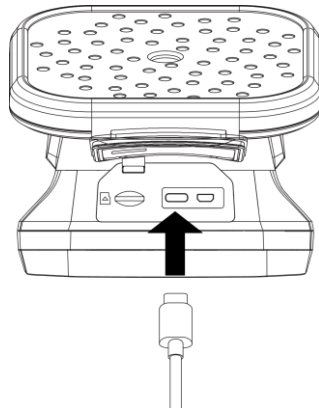

Figure 2-5 Charge via Type-C Cable

2.3.2 Charge Device via Charging Base

You can take out the battery and insert it into the charging base for fast charging.

Before You Start

Please make sure the device is power off before removing the battery.

Steps

1. Hold the device, and press both battery lock catches of the device.

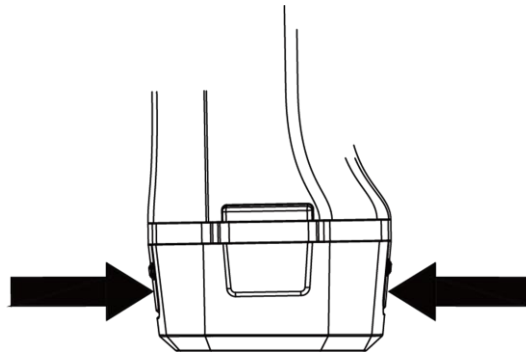

Figure 2-6 Remove Battery Base

2. Hold the lock catches, and draw the battery base to take out the battery.
3. Insert the battery into the charging base. You can see the charging status via the pilot lamp on the charging base.

Note

The red indicating light is on if the battery is charging properly, and the green indicating light is on if the battery is fully charged.

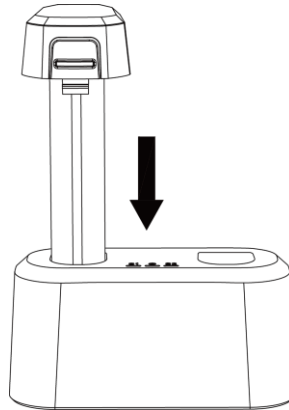



Figure 2-7 Charge Battery

4. When the battery is fully charged, draw the battery from the charging base.
5. Insert the battery into the device and push it into the locked position.

2.4 Power On/Off

Power On

Hold  to turn on the device. You can observe the target when the live view interface is stable.

Note



If the battery of the device is low, please charge it in time or replace it with a fully-charged standard battery, so as to ensure that the device functions normally.

Power Off

When the device is turned on, hold  to power off the device.

2.4.1 Set Auto Power-off Countdown

Steps

1. Press  in the live view interface to show the menu.
2. Go to Settings → Device Settings → Auto Off.
3. Tap Auto Off or press  to enable auto power-off.
4. Set the automatic shutdown time for device as required.
5. Press  to save and return to previous menu.

2.5 Sleep and Wake

Sleep and wake is used to save energy and increase battery time.

Sleep and Wake Manually

Press  to enter sleep mode and press again to wake device up.

Set Auto Sleep

In live view, press  to call the main menu. Go to Settings → Device Settings → Auto Sleep to set

waiting time before auto sleep. When there is no button pressing or screen tapping operation on

device for more than the set waiting time, device enters sleep mode automatically.

Device Sleep, Scheduled Capture and Video Recording

When the device is recording a video clip or on scheduled capturing, auto sleep will not be triggered. However, press  will stop the video recording or scheduled capture and force the device into sleep mode.

2.6 Live Interface and Menu

2.6.1 Live View Interface

After starting up, device screen shows the live view interface with detected acoustic wave.

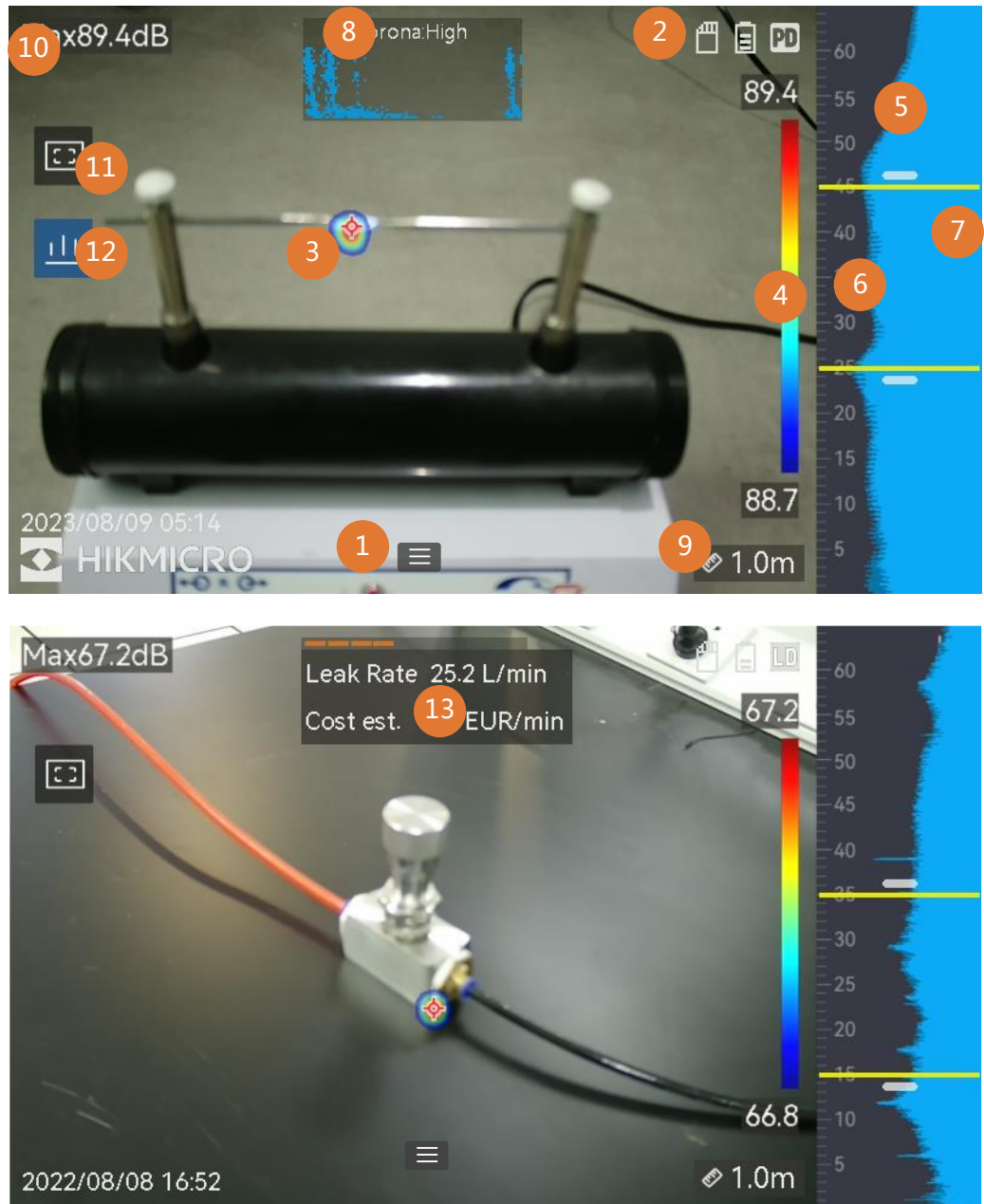

Figure 2-8 Live View Interface



Table 2-1 Live View Interface Description

No.	Part Name	Function
1	Menu Icon	Tap on the icon to call the main menu.
2	Status Bar	Device working status icons are displayed in the bar. You can turn on/off the display from Settings → Display Settings → Status Icons .
3	Acoustic Palette	The location and intensity of detected sound source are converted to palette colors overlaying on the visual image for easy observation. The size of palette stands for the intensity of the sound source. Bigger acoustic palette means higher sound intensity.
4	Intensity Scale (Palette Bar)	Intensity scale (palette bar) show the relation between displayed color and sound intensity. The value at the ends of the bar stands for the maximum and minimum intensity of the set frequency range. See <i>Set Palette Color</i> for setting instructions.
5	Frequency Band	Shows the supported frequency band of the device.
6	Selected Frequency Band / Target Frequency Range	Sound intensity of this frequency band is detected and converted to acoustic palette. See <i>Set Frequency</i> for instructions.
7	Dynamic Intensity of All Frequencies	Shows the intensity change of supported frequencies.
8 & 12	PRPD and its Control Icon	Only available in PD mode. Tap on icon (12) to display phase resolved partial discharge (PRPD) diagram for better PD activity diagnosis. Tap on PRPD diagram (8) to enlarge the display.

No.	Part Name	Function
9	Sound Source Distance	Shows the set distance of sound source. See <i>Set Sound Source Distance</i> for setting instructions.
10	Maximum Intensity	Stands for the detected maximum intensity of the scene. See <i>Mark and Display Peak Intensity</i> for setting instructions.
11	Regional Detection Frame	Tap on the icon to show a frame in the middle of the screen. The device only detects sound sources in the frame to reduce interference from less interested areas. See <i>Regional Detection Frame</i> for more information.
13	Gas Leakage Info.	Only available in LD mode. Shows detected gas leakage estimation. See <i>Gas Leakage Estimation</i> for more information.

2.6.2

Menus

In the live view interface, tap  or press  to show the menu bar, and swipe down to call the swipe-down menu.

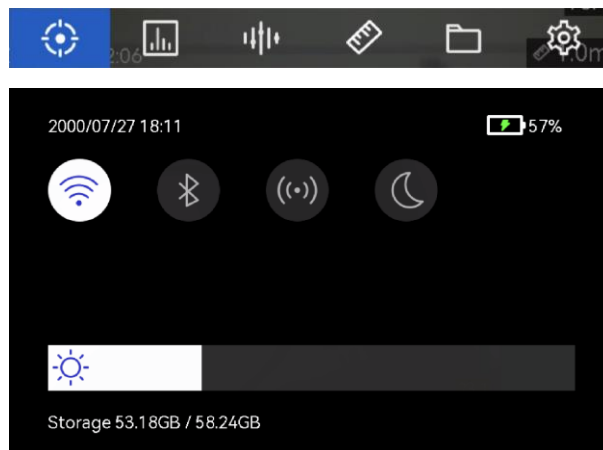













Figure 2-9 Main Menu and Swipe-Down Menu

Table 2-2 Menu Description

Menu Icon	Function
	Detection mode switch. Partial Discharge Detection (PD) and Gas Leakage Detection (LD) are supported.
	Adjusts detection sensitivity. Bigger value means higher sensitivity. See <i>Set Detection Sensitivity</i> for setting instructions.
	Pre-defined target frequency ranges for quick switching.
	Distance to sound source.
	Local albums of captured images and videos. See <i>View and Manage Local Files</i> for setting instructions.
	Settings of all device function.
	Tap to turn on/off device Wi-Fi. See <i>Connect Device to Wi-Fi</i> for setting instructions.
	Tap to turn on/off device Bluetooth. See <i>Pair Bluetooth Devices</i> for setting instructions.
	Tap to turn on/off device hotspot. See <i>Set Device Hotspot</i> for setting instructions.
	Tap to switch menu themes between dark and light.
	Swipe to adjust screen brightness.

3 Acoustic Wave Detection

The device supports acoustic wave detection among different frequency ranges. Detected sound source is marked acoustic palettes to show its dynamic location and intensity.

3.1 Set Detection Mode

The device supports partial discharge detection (PD) and gas leakage detection (LD).

Table 3-1 Application of PD and LD

Detection Mode	Application
Partial Discharge (PD)	Often used in electrical equipment and facility inspection. It detects abnormal partial discharges faults and instructs maintenance activities.
Gas Leakage (LD)	Often used in gas leakage detection of gas pipelines, tanks, valves, etc.

Steps



1. In the live view interface, tap  or press  to show the menu.
2. Select  to switch detection modes.



Figure 3-1 Switch Detection Mode

3.1.2 Partial Discharge Types and Levels

When detecting a partial discharge sound source, device automatically identify the type and strength level, and display the result on screen.

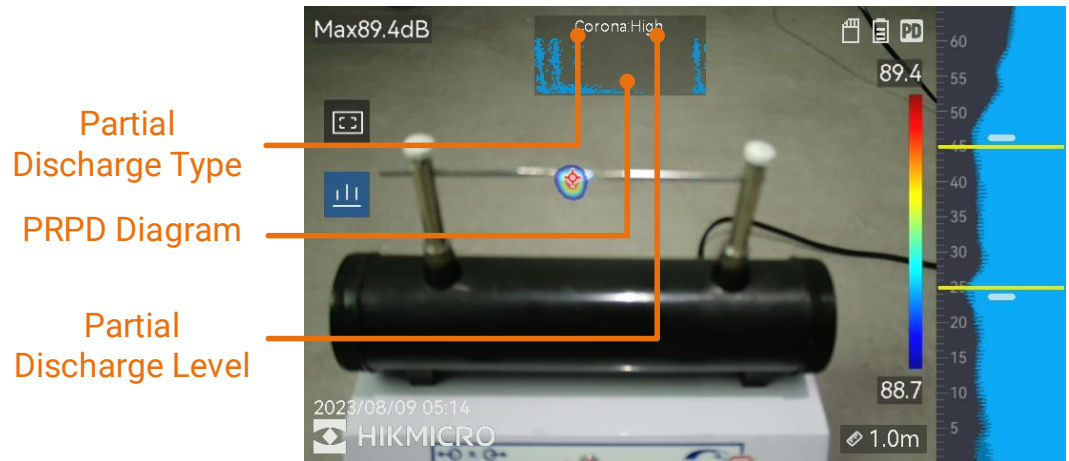

Figure 3-2 Partial Discharge Display

The explanation of screen display and the recommended handling are shown in the following tables.

Table 3-2 Partial Discharge Types

Partial Discharge Types	Explanation
Corona	Corona discharge occurs on the sharp surface of a conductor surrounded by gas. It usually happens in electrical systems like high-voltage power lines, transformers, or electrical motors.
Floating	Floating discharge, one of arcing discharges, happens when the electrical current flows through the conducting path created by voltage difference between two conductors. It might occur in various situations, such as high-voltage power transmission systems, electrical switches, circuit breakers, and welding equipment.
Surface	Surface discharge refers to the electrical discharge travels along the surface of insulation. It is primarily caused by the contamination and weather conditions like high humidity, of the insulator surface. It often occurs in high-voltage equipment, such as transformers, cables, switchgear, and motors.
Particle	Particle discharge refers to the partial discharge of electrical energy that interacts with metallic particles and debris present in the electrical systems. It can result from loose particles or particles generated by mechanical wear, corrosion, or degradation of insulation materials.
Noise	Other detected sound.

If different types of partial discharges coexist in the scene, the most prominent partial discharge type shows in live view.

Table 3-3 Partial Discharge Severity and Handling

Partial Discharge Severity	Recommended Handling
Normal	No observable/measurable deterioration.
Low	Minor deterioration which requires attention. Shorten inspection period and take maintenance actions when necessary.
Medium	Moderate deterioration. Locate and clean the Item during routine maintenance, or carry out related electrical test of the item. Or use online monitor to monitor the discharge tendency.
High	Serious deterioration. Item cannot be returned to service without shut down or engineering advise.





3.1.3 Gas Leakage Estimation

Device estimates and displays leak rate, level and possible cost for reference according to the set time unit, unit price, and currency.

 **Caution**

This product is designed to assess energy leakage to achieve energy savings. However, due to potential environmental factors that may impact detection accuracy, the estimations provided are approximate and for informational purposes only. It should be noted that the results presented by the devices are not a guarantee of actual energy savings or a recommendation, and may not accurately reflect the specific situation of your facilities.

Steps

1. In the live view interface, tap  or press  to show the menu.
2. Select , and switch to LD.
3. Select , and go to Acoustic Settings → Gas Leak Settings to set Unit Price, Time Unit, and Currency.
4. Return to live view interface. Aim the device to a gas leak source, and the real-time estimation displays on screen.

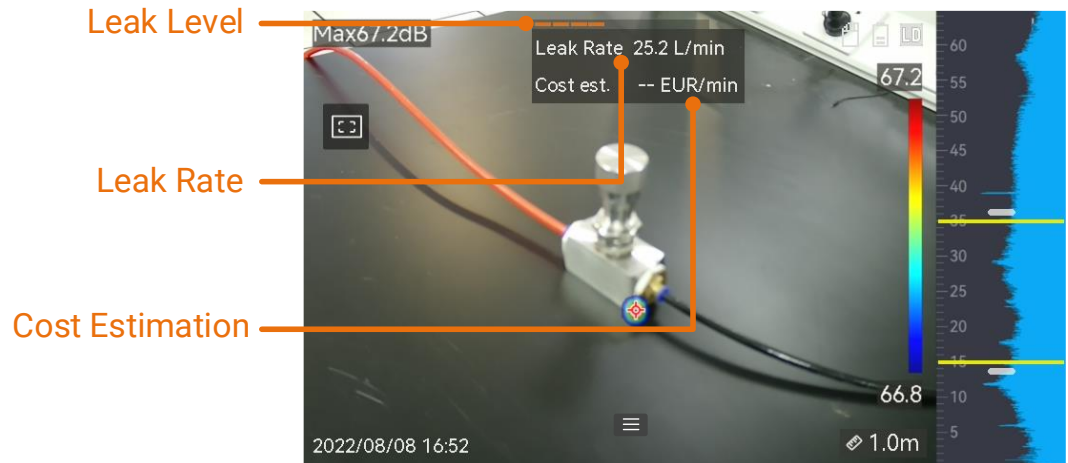

Figure 3-3 Gas Leak Estimation

3.2 Set Frequency

Steps

1. The device supports sound detection of two configurable frequency bands with different upper limit. Choose the one that better covers possible target frequencies from **Settings** → **Acoustic Settings** → **Frequency**.
2. Select a target frequency band, sound of which is visualized to acoustic palettes in the display for easy observation. You can switch among 3 pre-defined frequency ranges or adjust manually.

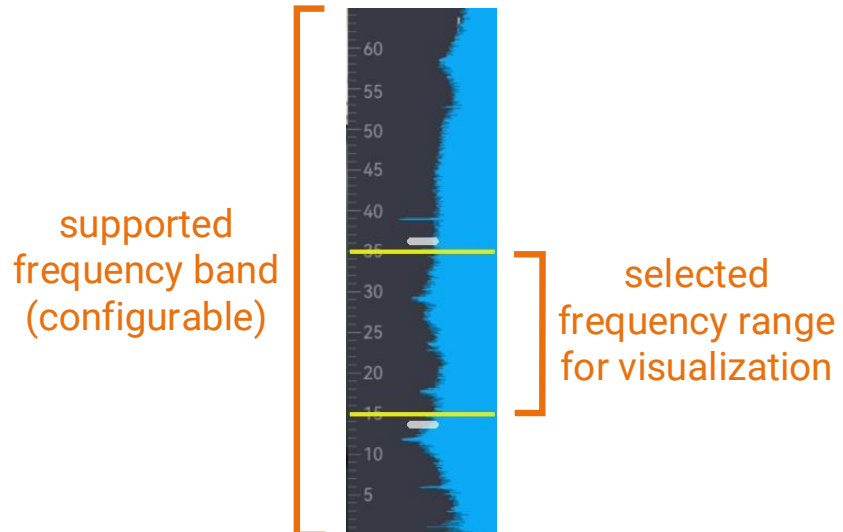





Figure 3-4 Frequency

3.2.1 Switch among Pre-defined Target Frequency Ranges

Steps





1. In the live view interface, tap  or press  to show the menu.
2. Select  and select a range option.

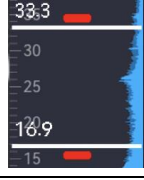

3.2.2 Set Target Frequency Range Manually

Steps

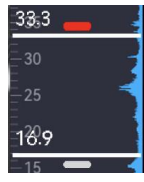
1. Select a subject for adjustment.

Table 3-4 Selected Frequency Adjustment

Objective	Operation	Operation Result
Adjust the upper and lower limits together.	Press  once or tap the area between the yellow lines.	
Adjust the upper limit only.	Press  twice or tap on the upper yellow line.	
Adjust the lower limit only.	Press  three times or tap on the lower yellow line.	



2. Press/hold  and  to adjust values.
3. Press  to save and exit.

3.3 Set Acoustic Palettes

Acoustic palettes are the shaped colors overlaying on visual image indicating the location and strength of detected sound source. Palette color, opacity and intensity range of palettes are adjustable.

3.3.1 Set Palette Color

Steps

1. Press  in the live view interface to show the menu.
2. Select  from the main menu, go to **Acoustic Settings** → **Palettes**, and select a desired color combination.
3. Press  to save and exit.



Result

Acoustic palette overlaid above the sound source and palette bar change to the selected palette.

3.3.2 Set Palette Opacity

You can view the acoustic palette and the visual images at the same time if the opacity is properly set.

Steps

1. In live view interface, tap  or press  to show the menu.
2. Go to **Settings** → **Acoustic Settings** → **Level**, and select a desired level.
3. Press  to save and exit.

Note

The opacity level ranges from 0% to 100%. The lower the value is, the more transparent the acoustic palette is.

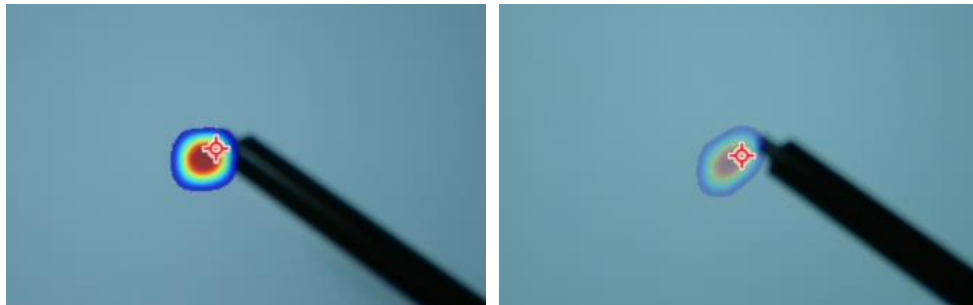

Level: 75% vs Level: 25%





3.3.3 Set Intensity Range for Palettes

Colors in palettes stand for different sound intensity values. Usually, device automatically calculates intensity range for palettes. You can also manually set a fixed range if the auto palette display is not satisfactory.

- **Auto (default):** Device calculates the upper limit, lower limit, and the intensity delta automatically.
- **Manual:** Device calculates the upper limit and lower limit of intensity according to the set intensity delta and actual intensity of target sound source.

Steps









1. In the live view interface, tap  or press  to show the menu.

2. Go to Settings → Acoustic Settings → Intensity Range, and press  to switch to Manual.
3. Select **Intensity Delta** and press .
4. Press/hold  and  to adjust values.
5. Press  to save and exit.

3.4 Set Sound Source Distance

Distance to sound source helps to increase the acoustic wave detection accuracy.







Steps

1. In live view interface, tap  or press  to show the menu.
2. Select .
3. Adjust the distance value by pressing/holding  and  or tapping  and .
4. Press  to save and exit.

3.5 Set Detection Sensitivity

Higher sensitivity means that sound source of lower intensity can be detected. Higher sensitivity also means that interferences are more easily to be detected and displayed.

Steps

1. In the live view interface, tap  or press  to show the menu.
2. Select .
3. Press  and  or tapping on screen to select a level. Bigger number means higher sensitivity.
4. Press  to save and exit.

3.6 More Tools

3.6.1 Mark and Display Peak Intensity

Mark peak intensity point with  and display the peak intensity value on screen.

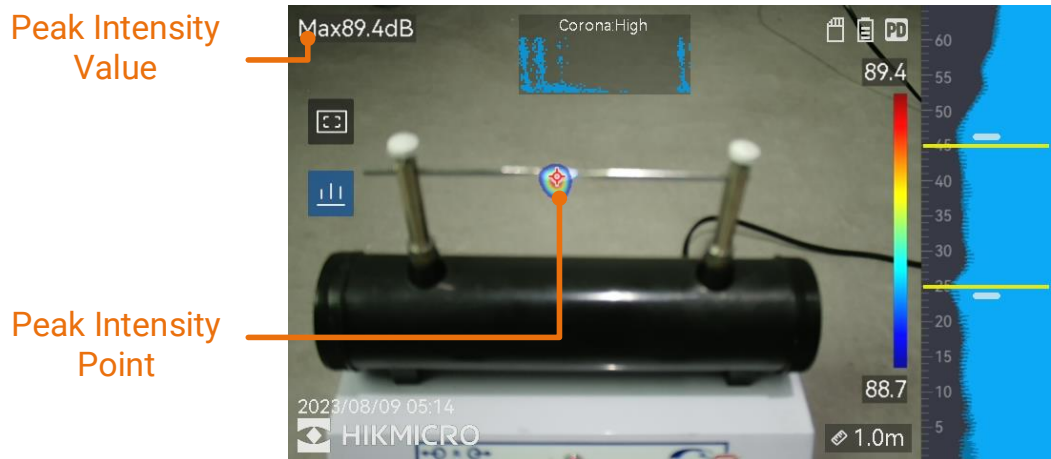





Figure 3-5 Mark Peak Intensity

Steps

1. In live view interface, tap  or press  to show the menu.
2. Go to Settings → Acoustic Settings → Sound Intensity Display.
3. Enable **Peak**.
4. Press  to save and exit.

3.6.2 Regional Detection Frame

If the target sound source is small and there is sound interference around, enable the regional detection frame and aim the frame to the target. Sound detection only carries out in the framed area.

Tap  to turn on/off regional detection frame.

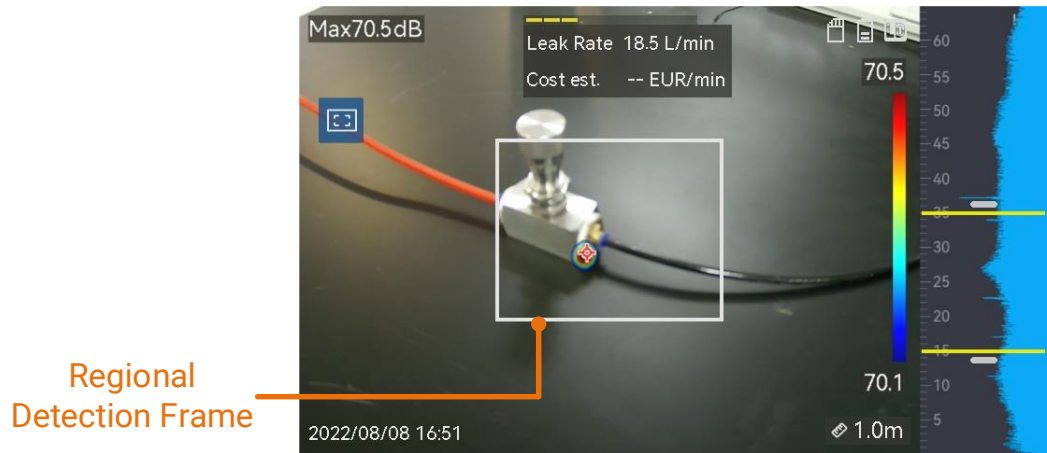

Figure 3-6 Regional Detection Frame



3.6.3 Show Multiple Sound Sources

Usually, device only displays acoustic palettes at the strongest sound source. If you want to see the other sound sources in the scene, turn on **Multiple Sources** from **Settings** → **Acoustic Settings** → **Multiple Sources**.

4 Display Settings

4.1 Set Screen Brightness

Steps

1. In the live view interface, tap  or press  to show the menu.
2. Select  from the main menu, go to **Device Settings** → **Screen Brightness**.
 - Auto: The device adjusts screen brightness automatically according to the ambient brightness.
 - Manually: Drag the brightness adjustment slider to the left or right to manually adjust screen brightness.

Note





You can also manually adjust brightness from swipe-down menu.



Figure 4-1 Brightness Adjustment Slider

4.2 Adjust Digital Zoom





The device supports 1× to 8× digital zoom.

- In the live view interface, hold  or  to zoom in or zoom out by 1× continuously.
- In the live view interface, press  or  to zoom in or zoom out by 0.1× precisely.

4.3 Display OSD Info.

OSD information informs you the status, time and date, and other information of the device in the live view interface.





Steps

1. In the live view interface, tap  or press  to show the menu.
2. Go to Settings → Display Settings.
3. Tap  or press  to select the on-screen information.
4. Press  to save and exit.

4.4 Set Grayscale of Visual Image

The colored live view image turns to black and white if grayscale image is enabled. The black and white image makes colored acoustic palettes more prominent for observation.

Steps

1. In the live view interface, tap  or press  to show the menu.
2. Go to Settings → Display Settings.
3. Tap  to enable **Grayscale Image**.
4. Press  to save and exit.

5 Picture and Video

Insert memory card into the device, and then you can record videos, capture images, and mark and save important data.

Note

- Device does not support capturing or recording when the menu is shown.
 - When the device is connected to your PC, it does not support capturing or recording.
 - Go to **Settings** → **Capture Settings** → **Filename Header**, you can set the filename header for capturing or recording to distinguish the files recorded in a specific scene.
 - Go to **Settings** → **Device Settings** → **Device Initialization** to initialize the memory card if needed.
-

5.1 Capture Picture

Operate the device to capture live images and save the images in local albums.

Before You Start

Make sure that there is a working memory card mounted in your device. See *Appearance* to locate the memory card slot of your device.

Steps

1. Set a capture mode and pull **Trigger** in live view interface to capture images. There are 3 modes available. Each mode requires different operations.
 - 1) Go to **Settings** → **Capture Settings** → **Capture Mode**.
 - 2) Select a mode.
 - **Capture One Image**: Pull **Trigger** once to capture one image.

- **Continuous Capture:** Set the continuous capture amount after select this mode. Pull **Trigger** in live view, and device captures the set amount of images continuously.
 - **Scheduled Capture:** Set the interval for scheduled capture after select this mode. Pull **Trigger** in live view, and the device captures images according to the set interval. Pull **Trigger** again or press ↶ to stop capturing.
- 3) Press ↶ to return to the live view interface.
 - 4) Aim the lens to your target and pull **Trigger** to capture images.
2. **Optional:** After capturing, you can tap the thumbnail of the captured image to view and edit the image.

What to do next

- Go to albums to view and manage files and album folders. See *Manage Albums* and *Manage Files* for operation instructions.
- To edit saved images, see *Edit Files* for operation instructions.
- You can connect your device to PC to export local files for further use. See *Export Files*.

5.2 Record Video

You can record videos of the target. The recorded video and audio are saved in the memory card.

Steps

1. In the live view interface, hold the trigger to start recording. The recording status icon and time icon appear.
2. When you finish, pull the trigger again to stop recording. The recorded video will be saved automatically and exit.

Note

You can also press OK or ↶ to stop recording.

3. Refer to Export Files to export the snapshots.



Note

The video format is MP4 format. You can play videos on the device or export to the compatible players to play.

5.3 View and Manage Local Files

Device captured images and videos are saved in local albums. You can create, delete, rename and set an album as the default saving album. For files, operations, such as browsing, moving and deleting, are available.



Steps





1. Enter album.
 - In live view, press  to enter albums.
 - In live view, press  to call the main menu, and select  to enter albums.
2. To create, rename, delete and set an album as the default saving album, see *Manage Albums* for instructions.
3. For file operations, such as, moving or deleting a file, see *Manage Files* for instructions.
4. To modify an image, for example, editing the text or voice notes saved with the images, see *Edit Files* for instructions.

5.3.2 Manage Albums

You can create several albums to manage captured images and video files on your device. Newly captured images and videos are saved in the **Default Saving Album** .

Steps

1. Enter albums.
 - In live view, press  to enter albums.
 - In live view, press  to call the main menu, and select  to enter albums.
2. Create an album.

- 1) Tap  in upper right corner to add an album.
 - 2) Edit the album name.
 - 3) Press  to save the album.
3. Rename, delete or set an album as the default saving album.
- 1) Select an album and press .
 - 2) Tap  in upper right corner of the screen.
 - 3) Select Set as Default Saving Album, Rename or Delete as required.
 - 4) The album icon turns to  when it is set as the default saving album.

5.3.3 Manage Files

Steps















1. Enter albums.
 - In live view, press  to enter albums.
 - In live view, press  to call the main menu, and select  to enter albums.
2. Select an album and press .
3. Browse the image and video files.
 - 1) Select a file and press .
 - 2) Press  and  to browse the previous or the next file.
 - 3) Press  to call the operation menu to check more available operations. File formats and their supported operations are shown below.

Table 5-1 File Formats and Operations

File Type	Format	Descriptions
Images	File Name.pd.jpeg File Name.ld.jpeg	Editing text and voice notes, moving files, checking basic information, and deleting files are supported on device.
Videos	File Name.pd.mp4 File Name.ld.mp4	Playing, moving and deleting video files are supported on device.

4. Moving or deleting several files.

- 1) In an album, tap  in the upper right corner of the screen.
- 2) Press  and  to select a file and press . If you want to select all files, tap  in the upper right corner. If you want to cancel all selection, tap .

A selected file displays with a  in its upper right corner.

- 3) Tap Delete or Move.
 - If you tap delete, files are deleted after confirmation.
 - If you tap move, select a target album to start moving.

5.3.4 Edit Files

Editing the text or voice notes saved with the images.

Steps















1. Enter albums.
 - In live view, press  to enter albums.
 - In live view, press  to call the main menu, and select  to enter albums.
2. Select an album and press .
3. Select a file and press  to call the editing menu.
4. Select an option and complete corresponding operations.

Table 5-2 Editing and Managing Images

Icon	Description
	Editing text note. Add a new text note or change the existed note, and press  to save the settings.
	Editing voice note. You can add a new voice note, play or delete an existed voice note. If the file already has a voice note, tap to play or delete the note. If the file has no voice note attached, press  or tap  to record one.
	Move the file to other albums. Select a target album and press  to confirm the moving.
	Show basic information of the file, for example, the saving time and resolution.
	Delete file.
	Play video.

5.4 Export Files

Connecting the device to your PC with supplied cable, you can export the recorded videos and captured snapshots.

Note

- Plug the type-C male connector of USB cable to the device and the other type-A connector to PC.
 - You can export the files using USB cable while the device is turned off.
 - You can export the files by inserting the memory card to your PC which has a card slot.
-

Steps

1. Open the cover of cable interface.
2. Connect the device to your PC with cable and open the detected disk.

3. Select and copy the videos or snapshots to PC to view the files.
4. Disconnect the device from your PC.

Note

You can play the recorded videos using the default players.

5.5 Analyze Snapshot via HIKMICRO Analyzer Acoustic

Captured snapshots can be imported to HIKMICRO Analyzer Acoustic PC client for further analysis and report generating.



Visit our website <http://www.hikmicrotech.com>, or contact us to get the software.

User guide is embedded in the client software for your reference.

6 Connect

6.1 Connect Device to Wi-Fi

Steps

1. Enter Wi-Fi setting interface. Choose from the following ways.
 - Tap and hold  from the swipe-down menu.
 - Go to **Settings** → **Connections** → **WLAN**.
2. Tap  to enable Wi-Fi, and the searched Wi-Fi will be listed.

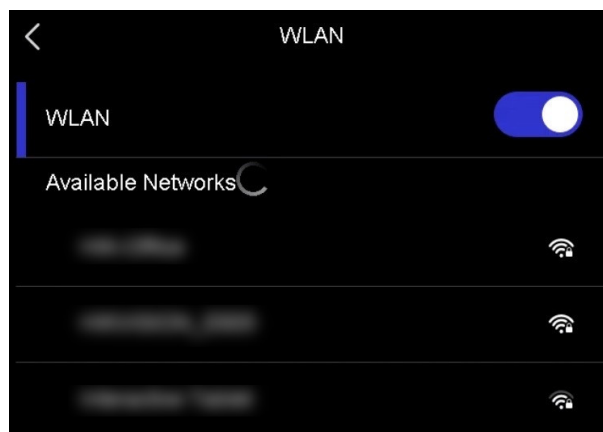



Figure 6-1 Wi-Fi List

3. Select Wi-Fi to connect to and a soft keyboard is displayed.
4. Enter the password.
5. Tap  to hide the keypad and connect Wi-Fi.

Note

- DO NOT tap **space**, or the password may be incorrect.
 - Leaving the Wi-Fi setting interface does not interrupt the connection.
-

Result

A Wi-Fi icon  shows in live view interface when the connection is completed.

6.2 Set Device Hotspot

When the device's hotspot is on, other equipment with Wi-Fi function can join the device for data transmission.

Steps

1. Enter hotspot configuration interface. Choose from the following ways.

- Tap and hold  from swipe-down.
- Go to **Settings** → **Connections** → **Hotspot**.

2. Tap  to enable hotspot function.

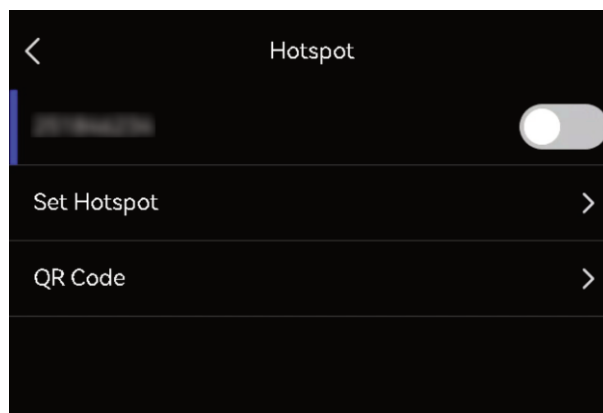



Figure 6-2 Hotspot

3. Set and join the hotspot.

Using hotspot password

- a. Tap **Set Hotspot**. A soft keyboard is displayed.
- b. Set the password for the hotspot by tapping the screen.
- c. Tap  to save.
- d. Enable the Wi-Fi function of other equipment and search the device hotspot to join.

Using hotspot QR code

- a. Tap **QR Code**. A QR code is displayed.
- b. Scan the QR code to join the hotspot.



Note

- When setting password, do not tap **space**, or the password may be incorrect.
 - The password should be at least 8 digits, consisting of numbers and characters.
 - Scanning function of some APP may fail to connect your phone to the device hotspot. Try other APPs.
-

6.3 Pair Bluetooth Devices

Pair your device with an external bluetooth player (speaker or headsets) to play the audio recorded together with the videos.

Steps

1. Enter bluebooth configuration page. Choose from the following ways.
 - Tap and hold  from swipe-down menu.
 - Select  from the main menu. Go to **Settings** → **Connections** → **Bluetooth**.
2. Tap on  to enable the bluetooth. The device searches and displays available nearby bluetooth devices.

Note

Make sure the external bluetooth device is in discoverable mode.

3. Tap to select an external bluetooth device to start automatic pairing and connecting.
-

Note

The Bluetooth function is for audio play only. If you want to exporting local files, see *Export Files* for instructions.

7 Maintenance

7.1 View Device Information

Go to **Settings** → **Device Settings** → **Device Information** to view the device information.

7.2 Set Language

Go to **Settings** → **Device Settings** → **Language** to set system language.

7.3 Set Time and Date

Steps

1. Press **OK** to show the menu in the live view interface.
2. Go to **Settings** → **Device Settings** → **Time and Date**.
3. Set the date and time.
4. Press **↶** to save and exit.

Note

Go to **Settings** → **Display Settings** to enable or disable time and date on-screen display.

7.4 Upgrade Device

Before You Start

- Please download the upgrade file from the official website <http://www.hikmicrotech.com> or contact the customer service and technical support to get the upgrade file first.
- Make sure that the device battery is fully charged.

- Make sure that Auto Power-off function is turned-off to avoid accidental suspension during upgrading.
- Make sure that a memory card has been installed to device.

Steps

1. Connect the device to your PC with a type-C to type A cable and open the detected disk.
2. Copy the upgrade file and paste it to the root directory of the device.
3. Disconnect the device from your PC.
4. Reboot the device and then it will upgrade automatically. The upgrading process will be displayed in the main interface.

Note

After upgrading, the device reboots automatically. You can view the current version in **Settings** → **Device Settings** → **Device Information**.

7.5 Restore Device

You can default the device to the factory settings.

Caution

This function should be used with caution.

Steps

1. Press  to show the menu in the live view interface.
2. Go to **Settings** → **Device Settings** → **Device Initialization**.
3. Select **Restore Device**. A prompt appears.
 - **OK**: Tap **OK** to initialize the device.
 - **Cancel**: Tap **Cancel** to exit and return to the previous menu.

8 FAQ

Scan the following QR code to get device common FAQ.



Legal Information

©2023 Hangzhou Microimage Software Co., Ltd. All rights reserved.

About this Manual

The Manual includes instructions for using and managing the Product. Pictures, charts, images and all other information hereinafter are for description and explanation only. The information contained in the Manual is subject to change, without notice, due to firmware updates or other reasons. Please find the latest version of this Manual at the HIKMICRO website (<http://www.hikmicrotech.com>).

Please use this Manual with the guidance and assistance of professionals trained in supporting the Product.

Trademarks



HIKMICRO and other HIKMICRO's trademarks and logos are the properties of HIKMICRO in various jurisdictions.

HDMI™: The terms HDMI and HDMI High-Definition Multimedia Interface, and the HDMI Logo are trademarks or registered trademarks of HDMI Licensing Administrator, Inc. in the United States and other countries.

Other trademarks and logos mentioned are the properties of their respective owners.

Disclaimer

TO THE MAXIMUM EXTENT PERMITTED BY APPLICABLE LAW, THIS MANUAL AND THE PRODUCT DESCRIBED, WITH ITS HARDWARE, SOFTWARE AND FIRMWARE, ARE PROVIDED "AS IS" AND "WITH ALL FAULTS AND ERRORS". HIKMICRO MAKES NO WARRANTIES, EXPRESS OR IMPLIED, INCLUDING WITHOUT LIMITATION, MERCHANTABILITY, SATISFACTORY QUALITY, OR FITNESS FOR A PARTICULAR PURPOSE. THE USE OF THE PRODUCT BY YOU IS AT YOUR OWN RISK. IN NO EVENT WILL HIKMICRO BE LIABLE TO YOU FOR ANY SPECIAL, CONSEQUENTIAL, INCIDENTAL, OR INDIRECT DAMAGES, INCLUDING, AMONG OTHERS, DAMAGES FOR LOSS OF BUSINESS PROFITS, BUSINESS INTERRUPTION,

OR LOSS OF DATA, CORRUPTION OF SYSTEMS, OR LOSS OF DOCUMENTATION, WHETHER BASED ON BREACH OF CONTRACT, TORT (INCLUDING NEGLIGENCE), PRODUCT LIABILITY, OR OTHERWISE, IN CONNECTION WITH THE USE OF THE PRODUCT, EVEN IF HIKMICRO HAS BEEN ADVISED OF THE POSSIBILITY OF SUCH DAMAGES OR LOSS.

YOU ACKNOWLEDGE THAT THE NATURE OF THE INTERNET PROVIDES FOR INHERENT SECURITY RISKS, AND HIKMICRO SHALL NOT TAKE ANY RESPONSIBILITIES FOR ABNORMAL OPERATION, PRIVACY LEAKAGE OR OTHER DAMAGES RESULTING FROM CYBER-ATTACK, HACKER ATTACK, VIRUS INFECTION, OR OTHER INTERNET SECURITY RISKS; HOWEVER, HIKMICRO WILL PROVIDE TIMELY TECHNICAL SUPPORT IF REQUIRED.

YOU AGREE TO USE THIS PRODUCT IN COMPLIANCE WITH ALL APPLICABLE LAWS, AND YOU ARE SOLELY RESPONSIBLE FOR ENSURING THAT YOUR USE CONFORMS TO THE APPLICABLE LAW. ESPECIALLY, YOU ARE RESPONSIBLE, FOR USING THIS PRODUCT IN A MANNER THAT DOES NOT INFRINGE ON THE RIGHTS OF THIRD PARTIES, INCLUDING WITHOUT LIMITATION, RIGHTS OF PUBLICITY, INTELLECTUAL PROPERTY RIGHTS, OR DATA PROTECTION AND OTHER PRIVACY RIGHTS. YOU SHALL NOT USE THIS PRODUCT FOR ANY PROHIBITED END-USES, INCLUDING THE DEVELOPMENT OR PRODUCTION OF WEAPONS OF MASS DESTRUCTION, THE DEVELOPMENT OR PRODUCTION OF CHEMICAL OR BIOLOGICAL WEAPONS, ANY ACTIVITIES IN THE CONTEXT RELATED TO ANY NUCLEAR EXPLOSIVE OR UNSAFE NUCLEAR FUEL-CYCLE, OR IN SUPPORT OF HUMAN RIGHTS ABUSES.

IN THE EVENT OF ANY CONFLICTS BETWEEN THIS MANUAL AND THE APPLICABLE LAW, THE LATTER PREVAILS.

Regulatory Information

These clauses apply only to the products bearing the corresponding mark or information.

FCC Compliance Statement

Please take attention that changes or modification not expressly approved by the party responsible for compliance could void the user's authority to operate the equipment.

This device complies with Part 15 of the FCC Rules. Operation is subject to the following two conditions:

- (1) This device may not cause harmful interference, and
- (2) This device must accept any interference received, including interference that may cause undesired operation.

This equipment complies with FCC radiation exposure limits set forth for an uncontrolled environment.

Note: This equipment has been tested and found to comply with the limits for a Class A digital device, pursuant to part 15 of the FCC Rules. These limits are designed to provide reasonable protection against harmful interference when the equipment is operated in a commercial environment. This equipment generates, uses, and can radiate radio frequency energy and, if not installed and used in accordance with the instruction manual, may cause harmful interference to radio communications. Operation of this equipment in a residential area is likely to cause harmful interference in which case the user will be required to correct the interference at his own expense.

EU Conformity Statement



This product and - if applicable - the supplied accessories too are marked with "CE" and comply therefore with the applicable harmonized European standards listed under the Directive 2014/30/EU (EMCD), Directive 2014/35/EU

(LVD), Directive 2011/65/EU (RoHS).

Restrictions in the 5 GHz band:

According to Article 10 (10) of Directive 2014/53/EU, when operating in the 5150 to 5350 MHz frequency range, this device is restricted to indoor use in: Austria (AT), Belgium (BE), Bulgaria (BG), Croatia (HR), Cyprus (CY), the Czech Republic (CZ), Denmark (DK), Estonia (EE), Finland (FI), France (FR), Germany (DE), Greece (EL), Hungary (HU), Iceland (IS), Ireland (IE), Italy (IT), Latvia (LV), Liechtenstein (LI), Lithuania (LT), Luxembourg (LU), Malta (MT), Netherlands (NL), Northern Ireland (UK(NI)), Norway (NO), Poland (PL), Portugal (PT), Romania (RO), Slovakia (SK), Slovenia (SI), Spain (ES), Sweden (SE), Switzerland (CH), and Turkey (TR).

Frequency Bands and Power

The frequency bands and modes and transmitting power (radiated and/or conducted) nominal limits applicable to the following radio equipment are as follows:

Wi-Fi: 2.4 GHz (2.4 GHz to 2.4835 GHz): 20 dBm; 5 GHz (5.15 GHz to 5.25 GHz): 23 dBm; 5 GHz (5.25 GHz to 5.35 GHz): 23 dBm; 5 GHz (5.47 GHz to 5.725GHz): 23 dBm; 5 GHz (5.725 GHz to 5.85 GHz): 14 dBm

Use the power adapter provided by a qualified manufacturer. Refer to the product specification for detailed power requirements.

Use the battery provided by a qualified manufacturer. Refer to the product specification for detailed battery requirements.



Directive 2012/19/EU (WEEE Directive): Products marked with this symbol cannot be disposed of as unsorted municipal waste in the European Union. For proper recycling, return this product to your local supplier upon the purchase of equivalent new equipment, or dispose of it at designated collection points. For more information see: www.recyclethis.info



Directive 2006/66/EC and its amendment 2013/56/EU (Battery Directive): This product contains a battery that cannot be disposed of as unsorted municipal waste in the European Union. See the product documentation for specific battery information. The battery is marked with this symbol, which

may include lettering to indicate cadmium (Cd), lead (Pb), or mercury (Hg). For proper recycling, return the battery to your supplier or to a designated collection point. For more information see: www.recyclethis.info.

Industry Canada ICES-003 Compliance

This device meets the CAN ICES-003 (A) / NMB-003 (A) standards requirements.

This device complies with Industry Canada licence-exempt RSS standard(s). Operation is subject to the following two conditions:

- (1) this device may not cause interference, and
- (2) this device must accept any interference, including interference that may cause undesired operation of the device.

This equipment complies with IC RSS-102 radiation exposure limits set forth for an uncontrolled environment.

For this device, please pay attention to the following notes when the device is operating in 5 GHz:

- (i) The device for operation in the band 5150-5250 MHz is only for indoor use to reduce the potential for harmful interference to co-channel mobile satellite systems;
- (ii) The maximum antenna gain permitted for devices in the bands 5250-5350 MHz and 5470-5725 MHz shall comply with the e.i.r.p. limit; and
- (iii) The maximum antenna gain permitted for devices in the band 5725-5825 MHz shall comply with the e.i.r.p. limits specified for point-to-point and non point-to-point operation as appropriate.

Users should also be advised that high-power radars are allocated as primary users (i.e. priority users) of the bands 5250-5350 MHz and 5650-5850 MHz and that these radars could cause interference and/or damage to LE-LAN devices.

Conformité Industrie Canada ICES-003

Cet appareil répond aux exigences des normes CAN ICES-003 (A)/NMB-003 (A).

Le présent appareil est conforme aux CNR d'Industrie Canada applicables aux appareils radioexempts de licence. L'exploitation est autorisée aux deux conditions suivantes :

- (1) l'appareil ne doit pas produire de brouillage, et
- (2) l'utilisateur de l'appareil doit accepter tout brouillage radioélectrique subi, même si le brouillage est susceptible d'en compromettre le fonctionnement.

ce matériel est conforme aux limites de dose d'exposition aux rayonnements, CNR-102 énoncée dans un autre environnement.

(i) Les dispositifs fonctionnant dans la bande 5150-5250 MHz sont réservés uniquement pour une utilisation à l'intérieur afin de réduire les risques de brouillage préjudiciable aux systèmes de satellites mobiles utilisant les mêmes canaux.

(ii) Le gain d'antenne maximal autorisé pour les appareils dans les bandes 5250-5350 MHz et 5470-5725 MHz doivent respecter le pire limiter; et

(iii) Le gain d'antenne maximal autorisé pour les appareils dans la bande 5725-5825 MHz doivent respecter le pire limites spécifiées pour le point-à-point et l'exploitation non point à point, le cas échéant.

Les utilisateurs de radars de haute puissance sont désignés utilisateurs principaux (c.-à-d., qu'ils ont la priorité) pour les bandes 5250-5350 MHz et 5650-5850 MHz et que ces radars pourraient causer du brouillage et/ou des dommages aux dispositifs LAN-EL.

KC

A 급 기기: 이 기기는 업무용(A 급) 전자파적합기기으로써 판매자 또는 사용자는 이 점을 주의하시기바라며, 가정 외의 지역에서 사용하는 것을 목적으로 합니다.



HIKMICRO

See the World in a New Way

Facebook: HIKMICRO Thermography

Instagram: hikmicro_thermography

E-mail: support@hikmicrotech.com

LinkedIn: HIKMICRO

YouTube: HIKMICRO Thermography

Website: <https://www.hikmicrotech.com/>

UD34826B