

User Manual

Thermal Scope

STELLAR 2.0 SERIES

V5.5.110 202407



Contact Us

CONTENTS

1	Overview	1
1.1	Main Function	1
1.2	Appearance.....	1
2	Preparation	4
2.1	Cable Connection	4
2.2	Install Battery.....	4
2.2.1	Battery Instruction	4
2.2.2	Battery Installation.....	4
2.3	Mount Device on Rail	5
2.4	Power On/Off.....	6
2.5	Auto Screen Off	8
2.6	Menu Description	8
2.7	App Connection	9
2.8	Firmware Status	10
2.8.1	Check Firmware Status	10
2.8.2	Upgrade Device.....	10
2.9	Zeroing (Overview).....	11
3	Image Settings	12
3.1	Adjust Diopter	12
3.2	Adjust Focus.....	12
3.3	Adjust Brightness	13
3.4	Adjust Contrast.....	13
3.5	Adjust Tone.....	13
3.6	Adjust Sharpness	14
3.7	Select Scene Mode.....	15
3.8	Set Palettes.....	16
3.9	Flat Field Correction.....	17
3.10	Correct Defective Pixel.....	18
3.11	Adjust Digital Zoom.....	18
3.12	Set Picture in Picture Mode	19
3.13	Set Image Pro	20
4	Zeroing.....	21
4.1	Set Reticle Mode	21
4.2	Select Zeroing Profile.....	21
4.3	Set Reticle.....	22
4.4	Correct Reticle	23
4.4.1	Correct Reticle on Device	23
4.4.2	Correct Reticle via HIKMICRO Sight	25
5	Measure Distance.....	27

6	General Settings	29
6.1	Set OSD	29
6.2	Set Brand Logo	29
6.3	Burning Prevention	30
6.4	Hot Tracking	30
6.5	Capture and Video	31
6.5.1	Capture Picture	31
6.5.2	Set Audio	31
6.5.3	Record Video	32
6.5.4	Prerecord Video	32
6.5.5	Local Album	33
6.6	Export Files	33
6.6.1	Export Files via HIKMICRO Sight	33
6.6.2	Export Files via PC	34
7	System Settings	36
7.1	Adjust Date	36
7.2	Synchronize Time	36
7.3	Set Language	36
7.4	Set Unit	37
7.5	Save Diagnostic Log	37
7.6	View Device Information	38
7.7	Restore Device	38
7.8	Reset Device	38
8	Frequently Asked Questions	39
8.1	Why is the monitor off?	39
8.2	The image is not clear, how to adjust it?	39
8.3	Capturing or recording fails. What's the problem?	39
8.4	Why the PC cannot identify the device?	39

1 Overview

HIKMICRO STELLAR 2.0 Thermal Scope adopts a 12 μm thermal detector with high sensitivity, ensuring perfect detail recognition even in the hardest weather conditions. The traditional-style 30 mm tube design meets the needs of professional hunters who value traditions and seek technological superiority. With extended operation time, the scope is mainly applied in field and forest hunting, adventuring, and recusing scenarios.

1.1 Main Function

- **Zeroing:** The reticle helps you to aim at the target fast and accurately. See *Zeroing*.
- **Auto Screen Off:** The function allows the device to enter standby mode/wake up through angle changes. The function darkens the screen to save energy and extend battery life.
- **Recoil-activated Video with Audio:** the device can automatically start recording before the recoil-activation and end recording after the recoil-activation.
- **Local Album:** Local album stores captured images and recoil-activated videos, which help you clarify whether you get the game immediately.
- **App Connection:** The device can capture snapshots, record videos, and set parameters by HIKMICRO Sight app after being connected to your phone via hotspot.
- **Image Correction:** The device supports DPC (Defective Pixel Correction) and FFC (Flat Field Correction) which can optimize the image quality.

1.2 Appearance



Note

- The appearance may vary according to different models. Please take the actual product for reference.
 - Pictures in this manual are for illustration purpose only. The actual product may be different.
-

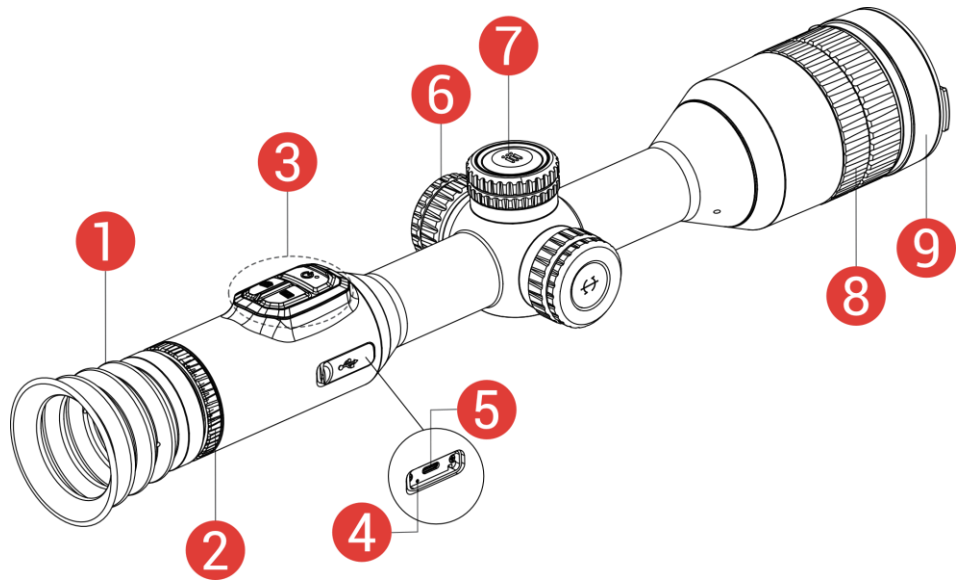



Figure 1-1 Appearance

Table 1-1 Description of Components





No.	Component	Description
1	Eyepiece	The piece placed closest to the eye to view the target.
2	Diopter Adjustment Ring	Adjusts the dioptic.
3	Buttons	To set functions and parameters.
4	Charging Status Indicator	Indicates the charging status of the device. <ul style="list-style-type: none"> ● Flashing Red & Green: Error occurred. ● Solid Red: Charging. ● Solid Green: Fully charged.
5	Type-C Interface	To connect the device to power supply or transmit data with a Type-C cable.
6	Battery Compartment	For holding the battery.
7	Wheel	To select functions and parameters and switch digital zoom.
8	Focus Ring	Adjusts focus to obtain clear targets.
9	Lens Cover	Protects the lens.

Button Description

Table 1-2 Button Description



Icon	Button	Function
	Power	<ul style="list-style-type: none"> ● Press: Standby mode/Wake up device. ● Hold: Power on/off.

Thermal Scope User Manual

	Capture	<ul style="list-style-type: none">● Press: Capture snapshots.● Hold: Start/Stop recording videos.
	Mode	<ul style="list-style-type: none">● Press: Switch palettes.● Hold: Correct non-uniformity of display (FFC).
	Wheel	Non-Menu Mode: <ul style="list-style-type: none">● Hold: Enter the menu.● Rotate: Switch digital zoom. Menu Mode: <ul style="list-style-type: none">● Press: Confirm/Set parameters.● Hold: Save and exit menu.● Rotate: Move up/move down.
 + 	Capture + Mode	Hold to lock/unlock the wheel.



Note

- The power indicator stays solid red when the device is on.
 - When the auto screen off function is enabled, if you press  to enter standby mode, you can also tilt or rotate the device to wake up the device. Refer to **Auto Screen Off** for detailed operation.
 - When the wheel is locked/unlocked, the icon  /  will be displayed.
-

2 Preparation

2.1 Cable Connection

Connect the device and power adaptor with a Type-C cable to power on the device. Alternatively, connect the device and PC to export files.

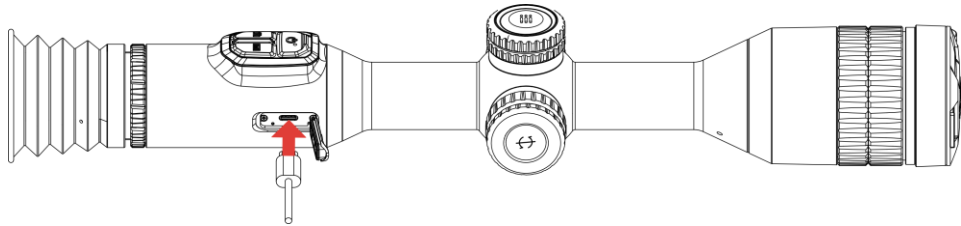

Figure 2-1 Cable Connection



Note

Charge the device for more than 6 hours before first use.

2.2 Install Battery

2.2.1 Battery Instruction

- Remove the external battery if the device is not used for a long time.
- The external rechargeable battery type is 18650, and the battery size should be 19 mm × 70 mm. The rated voltage is 3.635 V, and the battery capacity is 3200 mAh.
- The built-in battery type is rechargeable lithium-ion battery, and the battery size should be 23 mm × 67 mm. The rated voltage is 3.635 V, and the battery capacity is 3350 mAh.

2.2.2 Battery Installation

Insert the batteries into the battery compartment.

Steps

1. Turn the battery cover counterclockwise to loosen it.

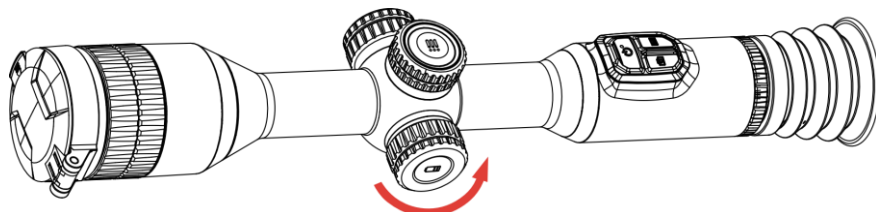

Figure 2-2 Loosen the Cover

2. Insert the battery into the battery compartment with the positive mark inward.

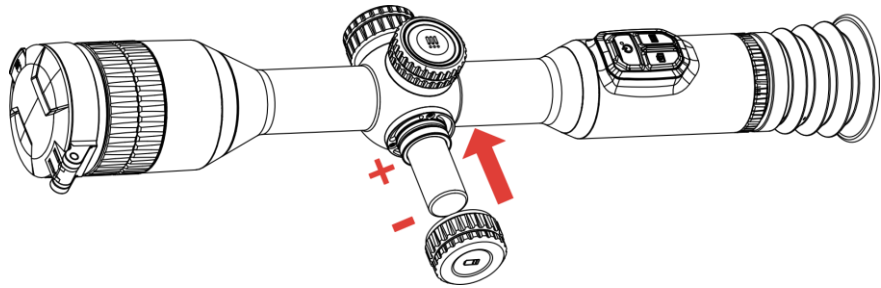

Figure 2-3 Insert the Battery

3. Turn the battery cover clockwise to tighten it.

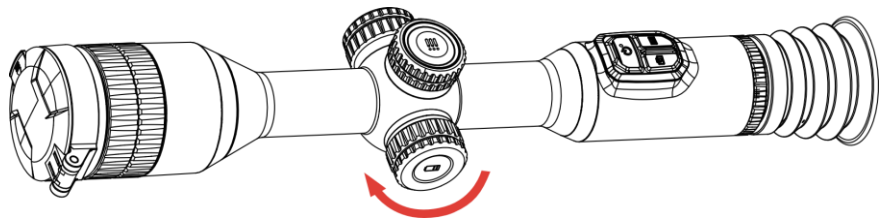

Figure 2-4 Tighten the Cover

2.3 Mount Device on Rail

Steps

1. Unscrew the ring top with Allen wrench.

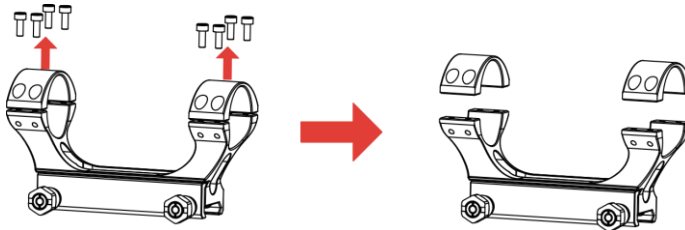

Figure 2-5 Unscrew the Ring Top

2. Place the device in the bottom half of the ring, and align the top holes with bottom holes.

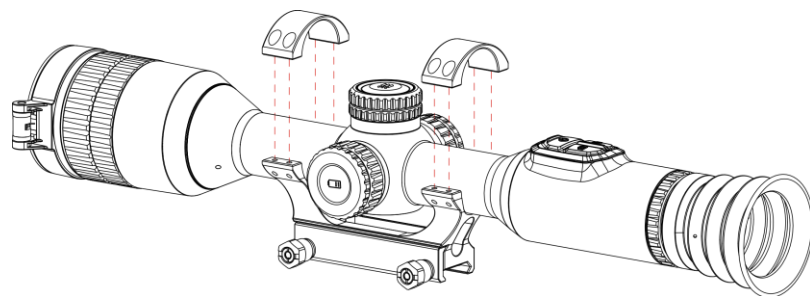

Figure 2-6 Place the Device in the Ring

3. Insert and tighten the screws.

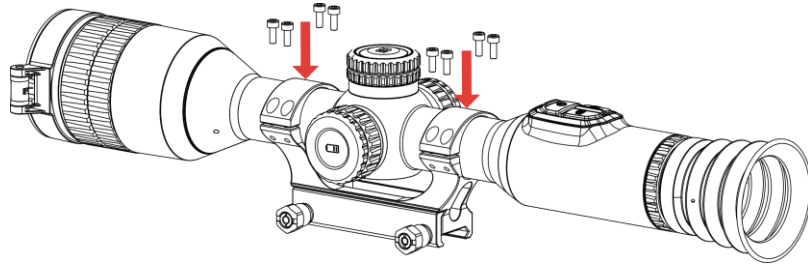

Figure 2-7 Tighten the Screws

4. Loosen the screws on the bottom half of the ring.

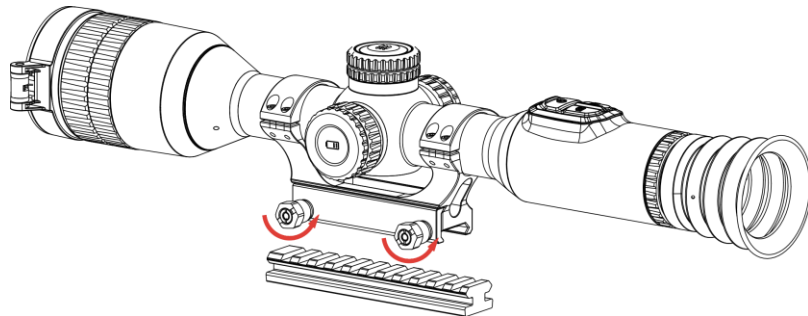

Figure 2-8 Loosen the Screws

5. Attach the bottom half of the ring to the rail, and tighten the screws on the ring. Make sure the device stays level.

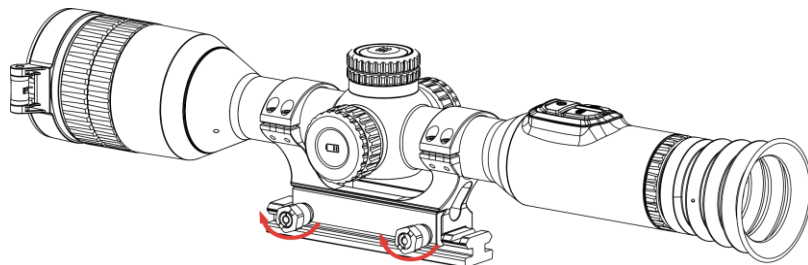

Figure 2-9 Tighten the Screws



Note

- The ring may vary according to different models. Please refer to the actual product.
 - The ring needs to be purchased separately.
 - Use lint-free cloth to clean the device base and the rail.
-

2.4 Power On/Off

Power On

When the device is connected to cable or the battery is sufficient, hold  to power on the device.

Power Off

When the device is turned on, hold  to power off the device.





Note

- Power-off countdown will appear when you power off the device. You can press any key to interrupt the countdown and cancel the power-off.
 - Automatic low battery power-off cannot be canceled.
-

Auto Power Off



You can set the auto power off time for your device.

Steps

1. Hold the wheel to show the menu.
 2. Go to  **Advanced Settings**.
 3. Rotate the wheel to select , and press the wheel to enter the configuration interface.
 4. Rotate the wheel to select the auto power off time as required, and press the wheel to confirm.
 5. Hold the wheel to save and exit.
-





Note

- See the battery icon for the battery status.  means the battery is fully charged,  means that the battery is low, and  means the battery charging is abnormal.
 - When the low power note shows, charge the battery.
 - The auto power off takes effect only when the device isn't in operation or connected with HIKMICRO Sight app.
 - The auto power off countdown will start again when the device reenters standby mode, or the device is restarted.
-

2.5 Auto Screen Off

Auto screen off function darkens the screen to save energy and increase battery time.

Steps

1. Enable auto screen off.
 - 1) Hold the wheel to show the menu.
 - 2) Go to  **Advanced Settings**, and rotate the wheel to select .
 - 3) Press the wheel to enable auto screen off.
 - 4) Hold the wheel to save settings and exit.
2. The device will enter standby mode by one of the following operations when the display is turned on:
 - Tilt the device downwards more than 70°.
 - Rotate the device horizontally more than 30°.
 - Keep the device still and do not move it for 5 minutes.
3. You can wake up the device by one of the following operations when the display is turned off:
 - Tilt the device downwards from 0° to 70° or upwards .
 - Rotate the device horizontally from 0° to 30°.
 - Press  to wake up the device.

2.6 Menu Description

In the live view interface, hold the wheel to show the menu.



Figure 2-10 Device Menu

2.7 App Connection

Connect the device to the HIKMICRO Sight app via hotspot, then you can capture picture, record video, or configure parameters on your phone.

Steps



1. Search the HIKMICRO Sight on App Store (iOS System) or Google Play™ (Android System) to download it, or scan the QR code to download and install the app.



Android System



iOS System

2. Hold the wheel to show the menu.
3. Go to  **Advanced Settings**, and rotate the wheel to select .
4. Press the wheel to enter the setting interface.
5. Rotate the wheel to select **Hotspot**. The hotspot function is enabled and the hotspot password is displayed.
6. Turn on the WLAN of your phone and connect to the hotspot.
 - Hotspot Name: HIKMICRO_Serial No.
 - Hotspot Password: Go to **Hotspot** in the menu to check the password.
7. Open the app and connect your phone with the device. You can view the interface of device on your phone.



Note

- The device cannot connect to the app if you enter wrong password several times. Refer to **Reset Device** to reset the device, and connect the app again.
 - If the password is not displayed, please upgrade the device to the latest version. Or enter the Serial No. as the password.
 - The hotspot will be turned off if there is no connection for over 10 minutes.
-

2.8 Firmware Status

2.8.1 Check Firmware Status

Steps

1. Open the HIKMICRO Sight and connect your device to the app.
2. Check if there is an upgrade prompt on the device management interface. If there is no upgrade prompt, the firmware is the latest version. Otherwise, the firmware is not the latest version.

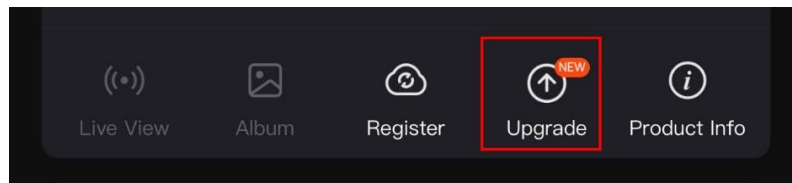

Figure 2-11 Check Firmware Status

3. (Optional) If the firmware is not the latest version, upgrade the device. See **Upgrade Device**.

2.8.2 Upgrade Device

Upgrade Device via HIKMICRO Sight

Steps

1. Open HIKMICRO Sight app and connect your device to the app.
2. Tap the upgrade prompt to enter the firmware upgrade interface.
3. Tap **Upgrade** to start upgrade.



Note

The upgrading operation may vary due to app updates. Please take the actual app version for reference.

Upgrade Device via PC

Before You Start

Please get the upgrade package first.

Steps

1. Connect the device to your PC with the type-C cable.

2. Open the detected disk, copy the upgrade file and paste it to the root directory of the device.
 3. Disconnect the device from your PC.
 4. Reboot the device, and the device upgrades automatically. The upgrading process will be displayed in the main interface.
-



Caution

During the upgrade package transmission, make sure the device is connected to your PC. Otherwise, it may cause unnecessary upgrade failure, firmware damage, etc.

2.9 Zeroing (Overview)

You can enable the reticle to view the position of the target. Functions such as freeze and zoom help to adjust the reticle more accurately. See **Zeroing** for detailed instructions.



Figure 2-12 Zeroing

3 Image Settings

3.1 Adjust Diopter

Steps

1. Power on the device.
2. Open the lens cover.
3. Hold the device and make sure the eyepiece covers your eye.
4. Adjust the diopter adjustment ring until the OSD information or image is clear.

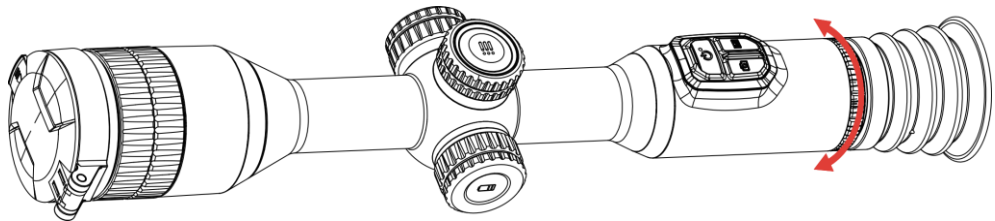

Figure 3-1 Adjust Diopter



Note

When adjusting diopter, DO NOT touch the surface of lens to avoid smearing the lens.

3.2 Adjust Focus

Steps

1. Power on the device.
2. Hold the device and make sure the eyepiece covers your eye.
3. Adjust the focus ring until the image is clear.

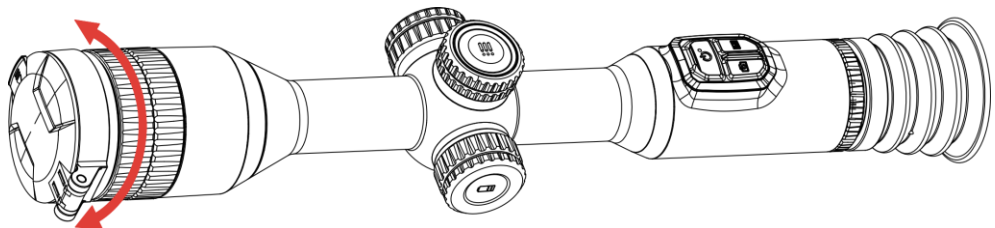

Figure 3-2 Adjust Focus



Note

When focusing, do not touch the surface of lens to avoid smearing the lens.

3.3 Adjust Brightness

You can adjust the display brightness of the screen in the menu.

Steps

1. Hold the wheel to show the menu.
2. Rotate the wheel to select  and press the wheel to confirm.
3. Rotate the wheel to adjust display brightness.
4. Hold the wheel to save settings and exit.

3.4 Adjust Contrast

Steps

1. Hold the wheel to show the menu.
2. Rotate the wheel to select  and press the wheel to confirm.
3. Rotate the wheel to adjust contrast.
4. Hold the wheel to save settings and exit.

3.5 Adjust Tone

Steps



1. Hold the wheel to show the menu.
2. Go to  **Advanced Settings**, rotate the wheel to select  and press the wheel to confirm.
3. Rotate the wheel to select a tone. **Warm** and **Cold** can be selected.
4. Hold the wheel to save and exit.



Figure 3-3 Adjust Tone

3.6 Adjust Sharpness

Steps



1. Hold the wheel to show the menu.
2. Go to  **Advanced Settings**, rotate the wheel to select  and press the wheel to confirm.
3. Rotate the wheel to adjust sharpness.
4. Hold the wheel to save settings and exit.





Figure 3-4 Sharpness Comparison

3.7 Select Scene Mode

You can select proper scene according to actual using scene to improve the display effect.

Steps

1. Hold the wheel to show the menu.
2. Go to  **Advanced Settings**, rotate the wheel to select  and press the wheel to confirm.
3. Rotate the wheel to switch scene.
 - **Recognition**: Recognition mode is recommended in normal scene.
 - **Jungle**: Jungle mode is recommended in hunting environment.
4. Hold the wheel to save settings and exit.

3.8 Set Palettes

You can select different palettes to display the same scene in different effects. Press  in the live view interface to switch palettes.

White Hot

The hot part is light-colored in view. The higher the temperature is, the lighter the color is.



Black Hot

The hot part is black-colored in view. The higher the temperature is, the darker the color is.



Red Hot

The hot part is red-colored in view. The higher the temperature is, the redder the color is.



Fusion



From high temperature to low temperature, the image is colored in from white, yellow, red, pink to purple.





3.9 Flat Field Correction

This function can correct non-uniformity of display.

Steps

1. Hold the wheel to show the menu.
2. Go to  **Advanced Settings**, rotate the wheel to select  **Image Calib.** and press the wheel to confirm.
3. Rotate the wheel to switch the image calibration modes, and press the wheel to confirm.

- **Auto FFC:** The device calibrates image automatically according to the set schedule when switching on the camera.
 - **Manual FFC:** In the live view interface, hold  to trigger calibration.
 - **External:** Cover the lens cover, and then hold  to trigger calibration in the live view interface.
4. Hold the wheel to save the settings and exit.





Note

The countdown will start before the device performs FFC automatically.

3.10 Correct Defective Pixel

The device can correct the defective pixels on the screen.

Steps

1. Hold the wheel to show the menu.
2. Go to  **Advanced Settings**, rotate the wheel to select  **DPC** and press the wheel to confirm.
3. Press the wheel to select the **X** or **Y** axis. Then rotate the wheel to set the coordinates until the cursor reaches the dead pixel.



Note

If you select **X** axis, the cursor moves left and right; if you select **Y** axis, the cursor moves up and down.

4. Press the wheel twice to correct the dead pixel.
5. Hold the wheel to save and exit.



Note

- The selected defective pixel can be magnified to view it more easily.
 - If the screen OSD blocks the defective pixel, move the cursor to reach the pixel and the device will perform mirror display automatically.
-

3.11 Adjust Digital Zoom

You can zoom in and out the image by using this function. Rotate the wheel in the live view interface to switch the digital zoom ratio, and the actual zoom ratio changes by the step of 1×.



Note

- When switching the digital zoom ratio, the left interface displays the actual magnification.
 - The zoom ratio may vary according to different models. Please take the actual product for reference.
-

3.12 Set Picture in Picture Mode

Steps

1. Hold the wheel to show the menu.
2. Rotate the wheel to select  and press the wheel to enable it. The details are shown in the upper center of the interface.
3. Hold the wheel to exit.



Figure 3-5 Picture in Picture Mode





Note

- When reticle is enabled, the PIP view is the detail of reticle. When reticle is turned off, the PIP view is the detail of central part.
 - If the PIP function is enabled, only the PIP view zooms when adjusting the digital zoom.
 - The zoom ratio will be temporarily displayed in the PIP view when adjusting the digital zoom.
-

3.13 Set Image Pro

Image pro refers to image detail enhancement. When you enable this function, the details of whole live view image will be enhanced.

Steps

1. Hold the wheel to show the menu.
2. Go to  **Advanced Settings**, rotate the wheel to select  and press the wheel to enable the function.
3. Hold the wheel to save settings and exit.

Result



The details of the whole live view image will be enhanced.

4 Zeroing

4.1 Set Reticle Mode

You can select a reticle mode according to your preference and different situations.

Steps

1. Hold the wheel to show the menu.
2. Go to  **Advanced Settings**, and rotate the wheel to select .
3. Press the wheel to enter the setting interface, and rotate the wheel to select a reticle mode.
 - **Central Reticle:** This mode centers around the reticle when switching the digital zoom ratio, with the reticle and zoomed image moved to the center of the display.
 - **Fixed Reticle:** This mode centers around the reticle when switching the digital zoom ratio, with the reticle position unchanged.
4. Hold the wheel to save and exit.





Note

- The actual zoom ratio returns to the min. value when switching the reticle mode.
 - The beginning continuous zoom ratio in central reticle mode is about 2× of that in fixed reticle mode.
 - The zoom ratio may vary according to different models. Please take the actual product for reference.
-

4.2 Select Zeroing Profile

You can configure and save the reticle settings in zeroing profiles according to various situation.

Steps

1. Hold the wheel to show the menu.
2. Go to  **Advanced Settings**, and rotate the wheel to select .
3. Rotate the wheel to select a zeroing profile.
4. Hold the wheel to save and exit.

Result

The right top of the image displays the reticle information. For example, A1-109yard means you are using the No. 1 reticle in zeroing profile A, and the set distance is 109 yards.



Figure 4-1 Using a Reticle



Note

There are 5 zeroing profiles in total, and you can configure 5 reticles in each zeroing profile.





4.3 Set Reticle

You can select a reticle in the current zeroing profile, and set parameters such as type, color, and position for the reticle.

Before You Start

Select a zeroing profile first.

Steps

1. Hold the wheel to show the menu.
2. Go to  **Advanced Settings**, and rotate the wheel to select  . Press the wheel to enter the setting interface.
3. Select  **Zeroing**, and press the wheel to confirm. Rotate the wheel to select a reticle No. You can select **OFF** to turn off the reticle.
4. Select  **Type**, and press the wheel to confirm. Rotate the wheel to select the reticle type. 10 types of reticles can be selected.

5. Select  **Color**, and press the wheel to confirm. Rotate the wheel to set the reticle color. **Black, White, Green, and Red** are selectable.
6. (Optional) Repeat 3 to 5 to set other reticles in this zeroing profile.



Note

When you switch the reticle No., a prompt will appear on the interface. Select **OK** to save the parameters for the current reticle.

7. Hold the wheel to exit according to the prompt.
 - **OK**: Save the parameter and exit.
 - **CANCEL**: Exit without saving the parameters.



Note

- 5 reticles can be configured in a zeroing profile.
 - If the PIP function is enabled, the aimed target can be magnified on the interface.
 - In black hot mode and white hot mode, if you set the reticle color as white or black, the color of the reticle will be inverted automatically to better aim at the target.
-

4.4 Correct Reticle



Correcting the reticle can help you aim at the target with high accuracy by marking the offset between the big reticle and small reticle. Functions such as **Freeze** and **Zoom** help to adjust the reticle more accurately.

4.4.1 Correct Reticle on Device

Before You Start

Select a zeroing profile first.

Steps

1. Hold the wheel to show the menu.
2. Go to  **Advanced Settings**, and rotate the wheel to select  . Press the wheel to enter the setting interface.
3. Select  **Zeroing**, and press the wheel to confirm. Rotate the wheel to select a reticle you want to correct.
4. Set the distance to the target.

Thermal Scope User Manual



- 1) Rotate the wheel to select  **Distance**.
 - 2) Press the wheel to select the number you want to change.
 - 3) Rotate the wheel to change the number, and press the wheel to finish the setting.
5. Select  **Zoom**, and press the wheel to confirm. Rotate the wheel to set the digital zoom ratio.
6. Aim at the target and pull the trigger. Align the reticle with the point of impact.
- 1) Aim the big reticle at the target.
 - 2) Select  **Freeze**. Press the wheel to enable the function.
 - 3) Rotate the wheel to set the coordinates until the big reticle aligns with the point of impact. Press the wheel to select axis. If you select X, the reticle moves left and right; if you select Y, the reticle moves up and down. Hold the wheel to finish setting.



Figure 4-2 Enable Freeze



Note

- When you switch the reticle No., a prompt will appear on the interface. Select **OK** to save the parameters for the current reticle.
 - When enabling the freeze function in reticle, you can adjust the position of the cursor on a frozen image. This function can prevent image flutter.
-
7. Hold the wheel to exit the setting interface according to the prompt.
 - **OK**: Save the parameters and exit.
 - **CANCEL**: Exit without saving the parameters.
 8. Pull the trigger again to verify that the aiming point aligns with the point of impact.
 9. (Optional) Repeat 3 to 8 to set the position for other reticles in this zeroing profile.

4.4.2 Correct Reticle via HIKMICRO Sight

You can also correct the reticle by HIKMICRO Sight app.

Before You Start

Install HIKMICRO Sight on your phone.

Step

1. Open HIKMICRO Sight and connect your device to the app.
2. Tap **Product Info**, and tap **Zero** to enter configuration interface.
3. Set reticle to the target.
 - 1) After synchronizing data from the device, select a zeroing profile.
 - 2) Select a reticle you want to correct.
 - 3) Input the number to set the distance to the target.
 - 4) Select digital zoom ratio.
4. Tap **Continue** and the parameters will be synchronized to the device, and take a few shots at the target.
5. Measure the deviation of the point of impact from the target, and tap **Completed** to input the number to adjust the position of reticle to ensure the big reticle aligns with the point of impact. Tap **Apply** to synchronize the parameters to the device.

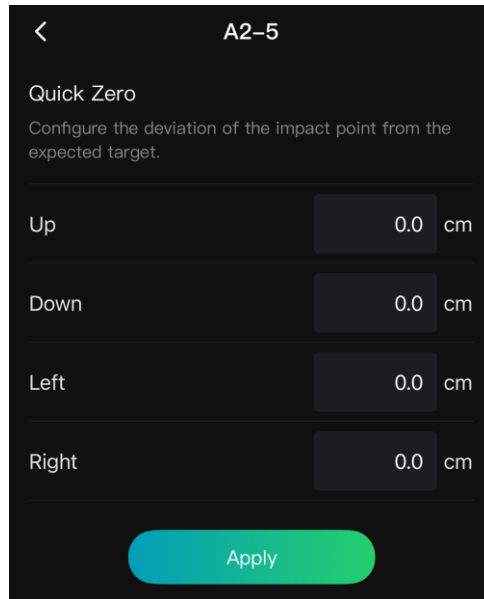

Figure 4-3 Quick Zero

6. Pull the trigger again and check the point of impact. Ensure the big reticle aligns with it.
7. Tap **Completed** to finish zeroing.
8. (Optional) Tap **Next Profile** to set the position for other reticles.

Result

The position of the reticle is saved and synchronized to your device, so you can check it on your device.



Note

- When you enter the zeroing setting interface on your app, the device will return to the live view interface automatically.
 - The zeroing operation may vary due to app updates. Please take the actual app version for reference.
-



5 Measure Distance

The device can detect the distance between the target and the observation position.

Before You Start

When measuring the distance, keep the hand and the position steady. Otherwise, the accuracy may be affected.

Steps

1. Hold the wheel to show the menu.
2. Go to  **Advanced Settings**, and rotate the wheel to select  .
Press the wheel to enter the setting interface.
3. Set the parameters for the target.
 - 1) Rotate the wheel to select the target from **Grey Wolf, Brown Bear, Deer, and Custom**.
 - 2) Press and rotate the wheel to set target height.



Note

The available height ranges from 0.1 m to 9.0 m.

- 3) Press the wheel to confirm.
- 4) Hold the wheel to save the settings and return to the distance measurement interface.
4. Align the center of top mark with the edge of target top, and press the wheel to confirm.
5. Align the center of bottom mark with the edge of target bottom, and press the wheel to confirm.

Result

The right top of the image displays the distance measurement result and the height of the target.





Figure 5-1 Measurement Result

6 General Settings

6.1 Set OSD

This function can display or hide the OSD information on the live view interface.

Steps

1. Hold the wheel to show the menu.
2. Go to  **Advanced Settings**, and rotate the wheel to select .
3. Press the wheel to enter OSD setting interface.
4. Rotate the wheel to select the **Time, Date, or OSD**, and press the wheel to turn on or turn off the selected OSD information.
5. Hold the wheel to save and exit.





Note

If you turn off **OSD**, all OSD information on the live view will not be displayed.

6.2 Set Brand Logo

You can add brand logo to the live view interface, snapshots, and videos.

Steps

1. Hold the wheel to show the menu.
2. Go to  **Advanced Settings**, and rotate the wheel to select .
3. Press the wheel to enable **Brand Logo**.
4. Hold the wheel to save the settings and exit.

Result

The brand logo is displayed at the bottom left of the image.





Figure 6-1 Brand Logo Display

6.3 Burning Prevention

Avoid direct sunlight and enable the burning prevention function to reduce the risk of sensor damage from the heat.



Steps

1. Hold the wheel to show the menu.
2. Go to  **Advanced Settings**, and rotate the wheel to select .
3. Press the wheel to enable or disable the **Burn-Prevention** function.
4. Hold the wheel to save the settings and exit.

6.4 Hot Tracking

The device can detect the highest temperature spot in the scene and mark it on display.

Steps

1. Hold the wheel to show the menu.
2. Go to  **Advanced Settings**, and rotate the wheel to select .
3. Press the wheel to enable the function and mark the spot of highest temperature.
4. Hold the wheel to save settings and exit.

Result



When the function is enabled,  displays in the spot of highest temperature. When the scene changes, the  moves.



Figure 6-2 Hot Tracking

6.5 Capture and Video

6.5.1 Capture Picture

In the live view interface, press  to capture picture.





Note

- When capturing succeeds, the image freezes for 1 second and a prompt shows on the display.
 - For exporting pictures, refer to **Export Files**.
-

6.5.2 Set Audio

If you turn on the audio function, the sound will be recorded with the video. When there is too loud noise in the video, you can turn off this function.

Steps

1. Hold the wheel to show the menu.
2. Go to  **Advanced Settings**, and rotate the wheel to select .
3. Press the wheel to enable or disable this function.
4. Hold the wheel to save settings and exit.

6.5.3 Record Video

Steps



1. In the live view interface, hold  to start recording.



Figure 6-3 Start Recording



The left image displays the information of recording time.

2. Hold  again to stop recording.

6.5.4 Prerecord Video

After you enable this function and select the prerecording time, the device can automatically start recording the 7, 10 or 15 seconds before the recoil-activation and end recording the 7, 10 or 15 seconds after the recoil-activation.

Steps

1. Hold the wheel to show the menu.
2. Go to  **Advanced Settings**, and rotate the wheel to select .
3. Press the wheel to enter the setting interface. Rotate the wheel to switch the prerecording time. 7 s, 10 s, and 15 s are selectable. You can also select **OFF** to turn off the function.
4. Hold the wheel to save settings and exit.

6.5.5 Local Album

Captured images and recorded videos are automatically stored in the device, and you can view the files in local albums.

Steps

1. Hold the wheel to show the menu.
2. Rotate the wheel to select .





Note

The albums are automatically created and named by year + month. The local pictures and videos of a certain month are stored in the corresponding album. For example, the pictures and videos of June in 2024 are saved in the album named 202406.

3. Rotate the wheel to select an album and press the wheel to enter it.
4. Rotate the wheel to select a file to view.
5. Press the wheel to view the selected file.



Note

- Files are arranged in chronological order, with the most recent at the top. If you fails to find the most recently taken snapshots or videos, please check the time and date settings of your device. When you are viewing files, you can switch to other files by rotating the wheel.
- When you are viewing videos, you can press the wheel to play or stop the video.
- For deleting an album or a file, you can hold  +  to call the dialogue box, and delete the album or file according to the prompt.

6.6 Export Files

6.6.1 Export Files via HIKMICRO Sight

You can access device albums and export files to your phone via HIKMICRO Sight.

Before You Start

Install HIKMICRO Sight on your mobile phone.

Steps

1. Open HIKMICRO Sight and connect your device to the app. See **App Connection**.
2. Tap **Media** to access device albums.

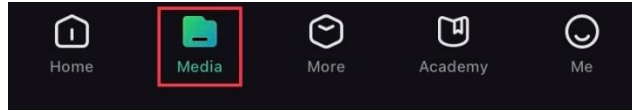

Figure 6-4 Access Device Albums

3. Tap **Local** or **Device** to view the photos and videos.
 - **Local**: You can view the files captured on app.
 - **Device**: You can view the files of the current device.



Note

The photos or videos may not show in **Device**. Please pull down to refresh the page.

4. Tap to select a file, and tap **Download** to export the file to your local phone albums.



Figure 6-5 Export Files



Note

- Go to **Me -> About -> User Manual** on the app to see more detailed operations.
 - You can also access device albums by tapping bottom left icon in the live view interface.
 - The exporting operation may vary due to app updates. Please take the actual app version for reference.
-

6.6.2 Export Files via PC

This function is used to export recorded videos and captured pictures.

Before You Start

Make sure the device is turned on when connecting the cable.

Steps

1. Connect the device and PC with the Type-C cable.



Note

Make sure the device is turned on when connecting the cable.

2. Open computer disk and select the disk of device. Go to the DCIM folder and find the folder named after the capture year and month. For example, if you capture a picture or record a video on June 2024, go to **DCIM -> 202406** to find the picture or video.
 3. Select and copy the files to PC.
 4. Disconnect the device from your PC.
-





Note

- The device displays images when you connect it to PC. But functions such as recording, capturing and hotspot are disabled.
 - When you connect the device to PC for the first time, it installs the drive program automatically.
-

7 System Settings



7.1 Adjust Date

Steps

1. Hold the wheel to show the menu.
2. Go to  **Advanced Settings**, and rotate the wheel to select .
3. Press the wheel to enter the configuration interface.
4. Press the wheel to select the year, month, or day, and rotate the wheel to change the number.
5. Hold the wheel to save settings and exit.

7.2 Synchronize Time



Step

1. Hold the wheel to show the menu.
2. Go to  **Advanced Settings**, and rotate the wheel to select .
3. Press the wheel to enter the configuration interface.
4. Rotate the wheel to switch the clock system. 24-hour and 12-hour clock are selectable. If you select 12-hour clock, press the wheel, and then rotate the wheel to select AM or PM.
5. Press the wheel to select the hour or minute, and rotate the wheel to change the number.
6. Hold the wheel to save settings and exit.

7.3 Set Language

You can select the device language in this function.

Steps



1. Hold the wheel to show the menu.
2. Go to  **Advanced Settings**, and rotate the wheel to select .
3. Press the wheel to enter the configuration interface.

4. Rotate the wheel to select the language as needed, and press the wheel to confirm.
5. Hold the wheel to save settings and exit.

7.4 Set Unit

You can switch the unit for distance measurement.



Steps

1. Hold the wheel to show the menu.
2. Go to  **Advanced Settings**, and rotate the wheel to select .
3. Press the wheel to enter the configuration interface.
4. Rotate the wheel to select the unit as required.
5. Hold the wheel to save settings and exit.

7.5 Save Diagnostic Log

This functions helps to collect and save device operation logs for troubleshooting.

Steps

1. Hold the wheel to show the menu.
2. Go to  **Advanced Settings**, and rotate the wheel to select .
3. Press the wheel to enable the function. The device will start to collect and record the device log.
4. Press the wheel to disable the function when the diagnostic log collection is completed.





Note

- When disabling the diagnostic log, a prompt will appear on the interface indicating the progress of diagnostic log collection. This operation cannot be interrupted. Once the log collection is completed, the prompt will disappear.
 - If you need to export the logs to the professionals, connect the device to your computer and copy the log files stored in the log folder of the device root directory. See **Export Files via PC**.
-

7.6 View Device Information



Steps

1. Hold the wheel to show the menu.
2. Go to  **Advanced Settings**, and rotate the wheel to select .
3. Press the wheel to confirm. You can view the device information such as the firmware version, serial No and available storage space of the device.
4. Hold the wheel to save settings and exit.

7.7 Restore Device

This function only restores the device basic settings to the factory defaults, such as brightness, contrast and PIP.



Steps

1. Hold the wheel to show the menu.
2. Go to  **Advanced Settings**, and rotate the wheel to select .
3. Press the wheel to restore the device basic settings to defaults according to the prompt.

7.8 Reset Device

This function erases all content and settings, including basic settings, storage, hotspot password, and zeroing.

Steps

1. Hold the wheel to show the menu.
2. Go to  **Advanced Settings**, and rotate the wheel to select .
3. Press the wheel to restore the device to defaults according to the prompt.

8 Frequently Asked Questions

8.1 Why is the monitor off?

- Check whether the device is off-battery, in standby mode or **Auto Power Off** is enabled.
- Check the monitor after charging the device for 5 minutes.

8.2 The image is not clear, how to adjust it?

Adjust the diopter adjustment ring or focus ring until the image is clear. Refer to *Adjust Diopter* or *Adjust Focus*.

8.3 Capturing or recording fails. What's the problem?

Check the following items.

- Whether the device is connected to your PC. Capturing or recording is disabled in this status.
- Whether the storage space is full.
- Whether the device is low-battery.

8.4 Why the PC cannot identify the device?

Check the following items.

- Whether the device is connected to your PC with supplied USB cable.
- If you use other USB cables, make sure the cable length is no longer than 1 m.

Legal Information

©Hangzhou Microimage Software Co., Ltd. All rights reserved.

About this Manual

The Manual includes instructions for using and managing the Product. Pictures, charts, images and all other information hereinafter are for description and explanation only. The information contained in the Manual is subject to change, without notice, due to firmware updates or other reasons. Please find the latest version of this Manual at the HIKMICRO website (www.hikmicrotech.com).

Please use this Manual with the guidance and assistance of professionals trained in supporting the Product.

Trademarks Acknowledgement

 **HIKMICRO** and other HIKMICRO's trademarks and logos are the properties of HIKMICRO in various jurisdictions.

Other trademarks and logos mentioned are the properties of their respective owners.

LEGAL DISCLAIMER

TO THE MAXIMUM EXTENT PERMITTED BY APPLICABLE LAW, THIS MANUAL AND THE PRODUCT DESCRIBED, WITH ITS HARDWARE, SOFTWARE AND FIRMWARE, ARE PROVIDED "AS IS" AND "WITH ALL FAULTS AND ERRORS". HIKMICRO MAKES NO WARRANTIES, EXPRESS OR IMPLIED, INCLUDING WITHOUT LIMITATION, MERCHANTABILITY, SATISFACTORY QUALITY, OR FITNESS FOR A PARTICULAR PURPOSE. THE USE OF THE PRODUCT BY YOU IS AT YOUR OWN RISK. IN NO EVENT WILL HIKMICRO BE LIABLE TO YOU FOR ANY SPECIAL, CONSEQUENTIAL, INCIDENTAL, OR INDIRECT DAMAGES, INCLUDING, AMONG OTHERS, DAMAGES FOR LOSS OF BUSINESS PROFITS, BUSINESS INTERRUPTION, OR LOSS OF DATA, CORRUPTION OF SYSTEMS, OR LOSS OF DOCUMENTATION, WHETHER BASED ON BREACH OF CONTRACT, TORT (INCLUDING NEGLIGENCE), PRODUCT LIABILITY, OR OTHERWISE, IN CONNECTION WITH THE USE OF THE PRODUCT, EVEN IF HIKMICRO HAS BEEN ADVISED OF THE POSSIBILITY OF SUCH DAMAGES OR LOSS.

YOU ACKNOWLEDGE THAT THE NATURE OF THE INTERNET PROVIDES FOR INHERENT SECURITY RISKS, AND HIKMICRO SHALL NOT TAKE ANY RESPONSIBILITIES FOR ABNORMAL OPERATION, PRIVACY LEAKAGE OR

OTHER DAMAGES RESULTING FROM CYBER-ATTACK, HACKER ATTACK, VIRUS INFECTION, OR OTHER INTERNET SECURITY RISKS; HOWEVER, HIKMICRO WILL PROVIDE TIMELY TECHNICAL SUPPORT IF REQUIRED.

YOU AGREE TO USE THIS PRODUCT IN COMPLIANCE WITH ALL APPLICABLE LAWS, AND YOU ARE SOLELY RESPONSIBLE FOR ENSURING THAT YOUR USE CONFORMS TO THE APPLICABLE LAW. ESPECIALLY, YOU ARE RESPONSIBLE, FOR USING THIS PRODUCT IN A MANNER THAT DOES NOT INFRINGE ON THE RIGHTS OF THIRD PARTIES, INCLUDING WITHOUT LIMITATION, RIGHTS OF PUBLICITY, INTELLECTUAL PROPERTY RIGHTS, OR DATA PROTECTION AND OTHER PRIVACY RIGHTS. YOU SHALL NOT USE THIS PRODUCT FOR ILLEGAL HUNTING ANIMALS, INVASION OF PRIVACY OR ANY OTHER PURPOSE WHICH IS ILLEGAL OR DETRIMENTAL TO THE PUBLIC INTEREST. YOU SHALL NOT USE THIS PRODUCT FOR ANY PROHIBITED END-USES, INCLUDING THE DEVELOPMENT OR PRODUCTION OF WEAPONS OF MASS DESTRUCTION, THE DEVELOPMENT OR PRODUCTION OF CHEMICAL OR BIOLOGICAL WEAPONS, ANY ACTIVITIES IN THE CONTEXT RELATED TO ANY NUCLEAR EXPLOSIVE OR UNSAFE NUCLEAR FUEL-CYCLE, OR IN SUPPORT OF HUMAN RIGHTS ABUSES.

PLEASE FOLLOW ALL THE PROHIBITIONS AND EXCEPTIONAL CAVEATS OF ALL APPLICABLE LAWS AND REGULATIONS, IN PARTICULAR, THE LOCAL FIREARMS AND/OR HUNTING LAWS AND REGULATIONS. PLEASE ALWAYS CHECK NATIONAL PROVISIONS AND REGULATIONS BEFORE PURCHASE OR USE OF THIS PRODUCT. PLEASE NOTE THAT YOU MAY HAVE TO APPLY FOR PERMITS, CERTIFICATES, AND/OR LICENSES BEFORE ANY PURCHASING, SELLING, MARKETING AND/OR USING OF THE PRODUCT. HIKMICRO SHALL NOT BE LIABLE FOR ANY SUCH ILLEGAL OR IMPROPER PURCHASING, SELLING, MARKETING, AND END USES AND ANY SPECIAL, CONSEQUENTIAL, INCIDENTAL, OR INDIRECT DAMAGES ARISING THEREOF.

IN THE EVENT OF ANY CONFLICTS BETWEEN THIS MANUAL AND THE APPLICABLE LAW, THE LATTER PREVAILS.

Regulatory Information

These clauses apply only to the products bearing the corresponding mark or information.

EU Conformity Statement



This product and - if applicable - the supplied accessories too are marked with "CE" and comply therefore with the applicable harmonized European standards listed under the Directive 2014/30/EU (EMCD), Directive 2014/35/EU (LVD), Directive 2011/65/EU (RoHS), Directive 2014/53/EU.

Hereby, Hangzhou Microimage Software Co., Ltd. declares that this device (refer to the label) is in compliance with Directive 2014/53/EU.

The full text of the EU declaration of conformity is available at the following internet address:

<https://www.hikmicrotech.com/en/support/download-center/declaration-of-conformity/>

Frequency Bands and Power (for CE)

The frequency bands and transmitting power (radiated and/or conducted) nominal limits applicable to the following radio equipment are as follows:

Wi-Fi 2.4 GHz (2.4 GHz to 2.4835 GHz), 20 dBm

For the device without a supplied power adapter, use the power adapter provided by a qualified manufacturer. Refer to the product specification for detailed power requirements.

For the device without a supplied battery, use the battery provided by a qualified manufacturer. Refer to the product specification for detailed battery requirements.



Directive 2012/19/EU (WEEE Directive): Products marked with this symbol cannot be disposed of as unsorted municipal waste in the European Union. For proper recycling, return this product to your local supplier upon the purchase of equivalent new equipment, or dispose of it at designated collection points. For more information see: www.recyclethis.info



Directive 2006/66/EC and its amendment 2013/56/EU (Battery Directive): This product contains a battery that cannot be disposed of as unsorted municipal waste in the European Union. See the product documentation for specific battery information. The battery is marked with this symbol, which may include lettering to indicate cadmium (Cd), lead (Pb), or mercury (Hg). For proper recycling, return the battery to your supplier or to a designated collection point. For more information see: www.recyclethis.info.

INFORMATIONEN FÜR PRIVATE HAUSHALTE

1. Getrennte Erfassung von Altgeräten:

Elektro- und Elektronikgeräte, die zu Abfall geworden sind, werden als Altgeräte bezeichnet. Besitzer von Altgeräten haben diese einer vom unsortierten Siedlungsabfall getrennten Erfassung zuzuführen. Altgeräte gehören insbesondere nicht in den Hausmüll, sondern in spezielle Sammel- und Rückgabesysteme.

2. Batterien und Akkus sowie Lampen:

Besitzer von Altgeräten haben Altbatterien und Altakkumulatoren, die nicht vom Altgerät umschlossen sind, die zerstörungsfrei aus dem Altgerät entnommen werden können, im Regelfall vor der Abgabe an einer Erfassungsstelle vom Altgerät zu trennen. Dies gilt nicht, soweit Altgeräte einer Vorbereitung zur Wiederverwendung unter Beteiligung eines öffentlich-rechtlichen Entsorgungsträgers zugeführt werden.

3. Möglichkeiten der Rückgabe von Altgeräten:

Besitzer von Altgeräten aus privaten Haushalten können diese bei den Sammelstellen der öffentlich-rechtlichen Entsorgungsträger oder bei den von Herstellern oder Vertriebern im Sinne des ElektroG eingerichteten Rücknahmestellen unentgeltlich abgeben. Rücknahmepflichtig sind Geschäfte mit einer Verkaufsfläche von mindestens 400 m² für Elektro- und Elektronikgeräte sowie diejenigen Lebensmittelgeschäfte mit einer Gesamtverkaufsfläche von mindestens 800 m², die mehrmals pro Jahr oder dauerhaft Elektro- und Elektronikgeräte anbieten und auf dem Markt bereitstellen. Dies gilt auch bei Vertrieb unter Verwendung von Fernkommunikationsmitteln, wenn die Lager- und Versandflächen für Elektro- und Elektronikgeräte mindestens 400 m² betragen oder die gesamten Lager- und Versandflächen mindestens 800 m² betragen. Verreiber haben die Rücknahme grundsätzlich durch geeignete Rückgabemöglichkeiten in zumutbarer Entfernung zum jeweiligen Endnutzer zu gewährleisten. Die Möglichkeit der unentgeltlichen Rückgabe eines Altgerätes besteht bei rücknahmepflichtigen Verreibern unter

anderem dann, wenn ein neues gleichartiges Gerät, das im Wesentlichen die gleichen Funktionen erfüllt, an einen Endnutzer abgegeben wird.

4. Datenschutz-Hinweis:

Altgeräte enthalten häufig sensible personenbezogene Daten. Dies gilt insbesondere für Geräte der Informations- und Telekommunikationstechnik wie Computer und Smartphones. Bitte beachten Sie in Ihrem eigenen Interesse, dass für die Löschung der Daten auf den zu entsorgenden Altgeräten jeder Endnutzer selbst verantwortlich ist.



5. Bedeutung des Symbols „durchgestrichene Mülltonne“:



Das auf Elektro- und Elektronikgeräten regelmäßig abgebildete Symbol einer durchgestrichenen Mülltonne weist darauf hin, dass das jeweilige Gerät am Ende seiner Lebensdauer getrennt vom unsortierten Siedlungsabfall zu erfassen ist.

Symbol Conventions

The symbols that may be found in this document are defined as follows.

Symbol	Description
 Note	Provides additional information to emphasize or supplement important points of the main text.
 Caution	Indicates a potentially hazardous situation, which if not avoided, could result in equipment damage, data loss, performance degradation, or unexpected results.
 Danger	Indicates a hazard with a high level of risk, which if not avoided, will result in death or serious injury.

Safety Instruction

These instructions are intended to ensure that user can use the product correctly to avoid danger or property loss. Please read all the safety information carefully before using.

Transportation

- Keep the device in original or similar packaging while transporting it.
- Keep all wrappers after unpacking them for future use. In case of any failure occurred, you need to return the device to the factory with the original wrapper. Transportation without the original wrapper may result in damage on the device and the company shall not take any responsibilities.
- Do not drop the product or subject it to physical shock. Keep the device away from magnetic interference.

Power Supply

- If a power adapter is provided in the device package, use the provided adapter only. If no power adapter is provided, ensure the power adapter or other power supply complies with Limited Power Source. Refer to the product label for the power supply output parameters.
- Make sure the plug is properly connected to the power socket.
- DO NOT connect multiple devices to one power adapter, to avoid overheating or fire hazards caused by overload.

Battery

- The external rechargeable battery type is 18650, and the battery size should be 19 mm × 70 mm. The rated voltage is 3.635 VDC, and the battery capacity is 3200 mAh.
- The built-in battery type is rechargeable lithium-ion battery, and the battery size should be 23 mm × 67 mm. The rated voltage is 3.635 V, and the battery capacity is 3350 mAh.
- CAUTION: Risk of explosion if the battery is replaced by an incorrect type. Replace with the same or equivalent type only.
- Batteries of improper size cannot be installed, and may cause abnormal shutdown.
- Improper replacement of the battery with an incorrect type may defeat a safeguard (for example, in the case of some lithium battery types).
- Please purchase the batteries recommended by the manufacturer if necessary.
- The purchased batteries by users need to comply with the relevant international standards about battery safety (e.g. EN/IEC standards).

- Use the battery provided by qualified manufacturer. Refer to the product specification for detailed battery requirements.
- Dispose of used batteries according to the instructions.
- Remove the battery if you do not use the device for a long time.
- For long-term storage of the battery, make sure it is fully charged every half year to ensure the battery quality. Otherwise, damage may occur.
- The built-in battery cannot be dismantled. Please contact the manufacture for repair if necessary.
- Make sure the battery temperature is between 0°C to 45°C (32°F to 113°F) when charging.
- Do not dispose of the battery into fire or a hot oven, or mechanically crush or cut the battery, which may result in an explosion.
- Do not leave the battery in an extremely high temperature or low air pressure environment, which may result in an explosion or the leakage of flammable liquid or gas.
- Confirm there is no flammable material within 2 m of the charger during charging.
- DO NOT place the device with battery or the battery alone near heating or fire source. Avoid direct sunlight.
- DO NOT place the battery in the reach of children.
- DO NOT swallow the battery to avoid chemical burns.

Maintenance

- If the product does not work properly, please contact your dealer or the nearest service center. We shall not assume any responsibility for problems caused by unauthorized repair or maintenance.
- Make sure that the power has been disconnected before device teardown and repair by professionals.
- Wipe the device gently with a clean cloth and a small quantity of ethanol, if necessary.
- If the equipment is used in a manner not specified by the manufacturer, the protection provided by the device may be impaired.
- Clean the lens with soft and dry cloth or wiping paper to avoid scratching it.

Using Environment

- Make sure the running environment meets the requirement of the device. The operating temperature shall be -30 °C to 55 °C (-22 °F to 131 °F), and the operating humidity shall be from 5% to 95%.
- DO NOT expose the device to high electromagnetic radiation or dusty environments.
- DO NOT aim the lens at the sun or any other bright light.

- Place the device in a dry and well-ventilated environment.
- When any laser equipment is in use, make sure that the device lens is not exposed to the laser beam, or it may burn out.
- Avoid equipment installation on vibratory surface or places subject to shock (neglect may cause equipment damage).
- This equipment is not suitable for use in locations where children are likely to be present.

Emergency

If smoke, odor, or noise arises from the device, immediately turn off the power, unplug the power cable, and contact the service center.

Limited Warranty

Scan the QR code for the product warranty policy.



Manufacture Address

Room 313, Unit B, Building 2, 399 Danfeng Road, Xixing Subdistrict,
Binjiang District, Hangzhou, Zhejiang 310052, China

Hangzhou Microimage Software Co., Ltd.

COMPLIANCE NOTICE: The thermal series products might be subject to export controls in various countries or regions, including without limitation, the United States, European Union, United Kingdom and/or other member countries of the Wassenaar Arrangement. Please consult your professional legal or compliance expert or local government authorities for any necessary export license requirements if you intend to transfer, export, re-export the thermal series products between different countries.



 Hikmicro Hunting.Global

 Hikmicro Hunting.Global

 HIKMICRO Outdoor

 HIKMICRO

 www.hikmicrotech.com

 support@hikmicrotech.com

UD38904B