



# Digital Night Vision Monocular CHEETAH LRF Series

User Manual V5.5.76 202311



Contact Us

## Table of Contents

Chapter 1 Overview .....	1
1.1 Device Description.....	1
1.2 Main Function .....	1
1.3 Appearance.....	1
Chapter 2 Preparation .....	4
2.1 Cable Connection .....	4
2.2 Install Adapter.....	4
2.3 Remove Adapter .....	5
2.4 Install Battery .....	5
2.4.1 Battery Instruction .....	5
2.4.2 Battery Installation .....	5
2.5 Power On/Off .....	6
2.6 Menu Description .....	7
2.7 App Connection .....	7
2.8 Firmware Status .....	8
2.8.1 Check Firmware Status .....	8
2.8.2 Upgrade Device.....	9
2.9 Calibrate Image .....	9
Chapter 3 Image Settings .....	11
3.1 Adjust Focus .....	11
3.2 Adjust Brightness .....	11
3.3 Adjust Contrast.....	12
3.4 Set Display Mode.....	12
3.5 Calibrate Image .....	12
Chapter 4 Measure Distance .....	14
Chapter 5 General Settings .....	15
5.1 Set OSD .....	15
5.2 Set Brand Logo .....	15

# Digital Night Vision Monocular User Manual

---

5.3 Capture Picture .....	15
5.4 Set Audio .....	16
5.5 Record Video .....	16
5.6 Prerecord Video .....	16
5.7 Export Files .....	17
5.7.1 Export Files via HIKMICRO Sight .....	17
5.7.2 Export Files via PC .....	18
Chapter 6 System Settings .....	19
6.1 Adjust Date .....	19
6.2 Synchronize Time .....	19
6.3 Set Language .....	19
6.4 Set Unit .....	20
6.5 View Device Information .....	20
6.6 Restore Device .....	20
Chapter 7 Frequently Asked Questions .....	21
7.1 Why is the monitor off? .....	21
7.2 The image is not clear, how to adjust it? .....	21
7.3 Capturing or recording fails. What's the problem? .....	21
7.4 Why the PC cannot identify the device? .....	21
Safety Instruction .....	22
Legal Information .....	25
Regulatory Information .....	27

# Chapter 1 Overview

## 1.1 Device Description

The digital night vision monocular can perform in all ambient light. It has an advanced HD sensor and a high resolution OLED display, which provides full-color clarity in daytime and classic black & white viewing at night. This device meets the needs of professional hunters who value traditions and seek technological superiority. The device is applicable for scenarios such as field and forest hunting, hiking, and rescuing.

## 1.2 Main Function

- Built-in Laser Rangefinder: The device allows you to determine the distance in various scenarios with built-in laser rangefinder module.
- Display Mode: The device supports multiple display modes, and you can set day mode, night mode, defog mode, or auto mode according to the scene.
- App Connection: The device can capture snapshots, record videos, and set parameters by HIKMICRO Sight App after being connected to your phone via hotspot.

## 1.3 Appearance

---

 **Note**

Pictures in this manual are for illustration purpose only. Please take the actual product for reference.

---

The appearance description of the digital night vision monocular is shown below. Please take the actual product for reference.

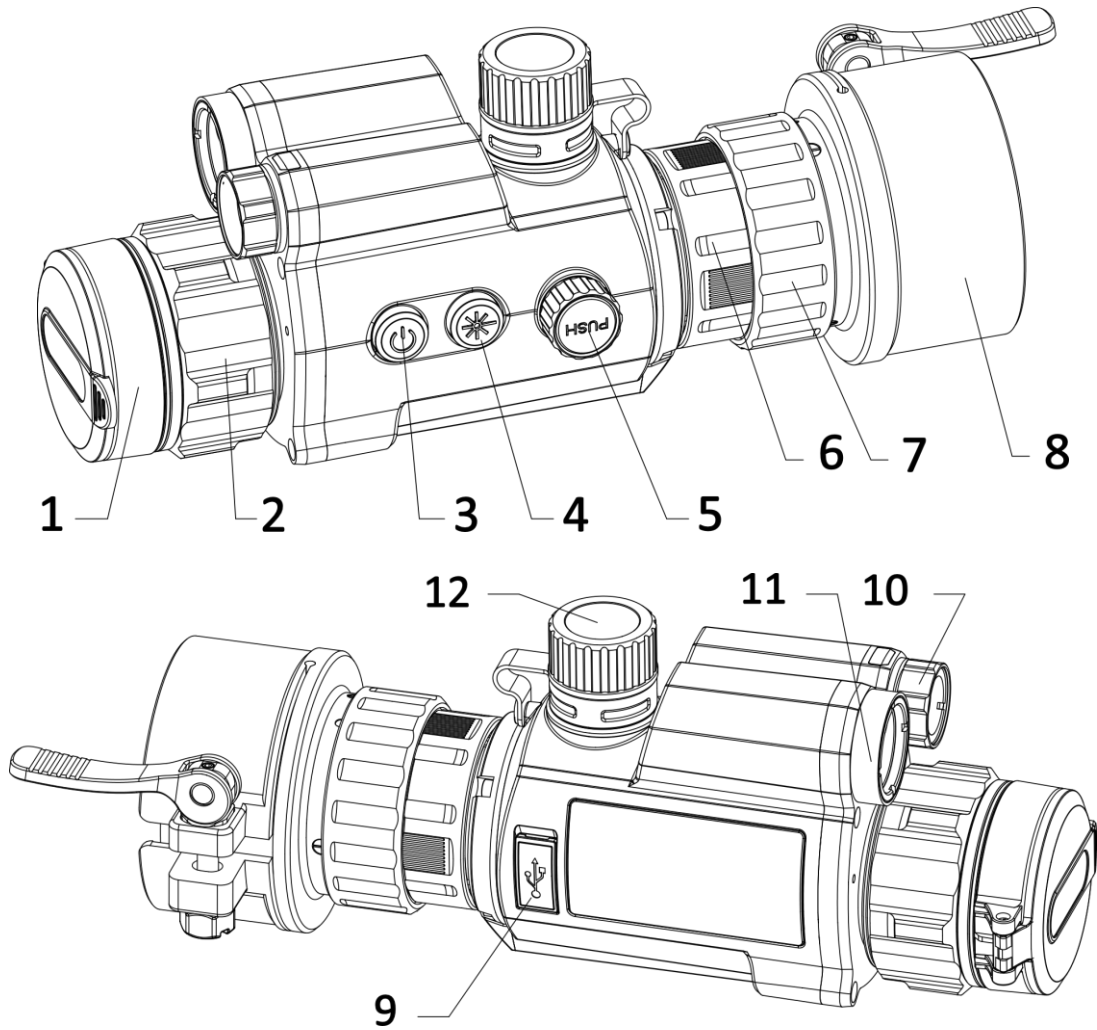

Figure 1-1 Device Appearance

Table 1-1 Buttons and Components

No.	Description	Function
1	Lens Cover	Protect the lens.
2	Focus Ring	Adjust the focus to find clear targets.
3	Power Key	<ul style="list-style-type: none"> <li>● Press: standby mode/wake up device</li> <li>● Hold: power on/off</li> </ul>
4	Laser Key	<ul style="list-style-type: none"> <li>● Hold: switch display modes</li> <li>● Press: start laser ranging</li> <li>● Double Press: Turn off laser ranging</li> </ul>
5	Wheel	<ul style="list-style-type: none"> <li>● Press: start/stop recording</li> <li>● Hold: menu operation</li> <li>● Double press: display/hide OSD</li> </ul>

## Digital Night Vision Monocular User Manual

---

No.	Description	Function
6	Fixing Ring	Fix the clip-on eyepiece to the device.
7	Locking Ring	Lock the adapter with the clip-on eyepiece.
8	Adapter	Connect to optical lens. It has four types: 38 mm, 40 mm, 50 mm, and 62 mm.
9	Type-C Interface	Connect the device to power supply or transmit data with a type-C cable.
10	Laser Range Finder	Measure the distance with laser.
11	Infrared Light	Help to view target clearly in dark environment.
12	Battery Compartment	Install the battery in it.
4 + 5	Laser Key + Wheel	Press to capture snapshots.

## Chapter 2 Preparation

### 2.1 Cable Connection

Connect the device and power adaptor with a type-C cable to power on the device. Alternatively, connect the device and PC to export files.

#### Steps

1. Lift the cable interface cover.
2. Connect the device and power adaptor with a Type-C cable to power on the device. Alternatively, connect the device and PC to export files.

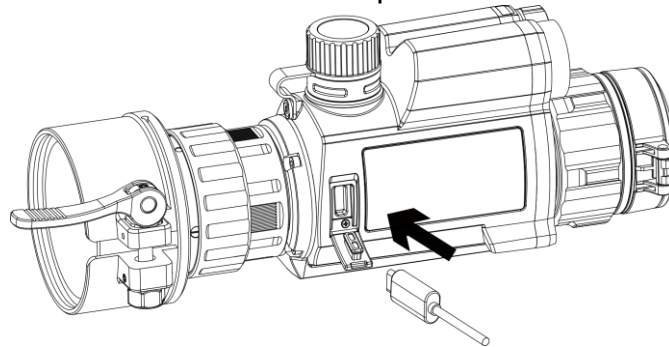

Figure 2-1 Cable Connection

### 2.2 Install Adapter

#### Steps

1. Make sure the red dot of the adapter align with the red dot of the eyepiece, and insert the adapter as arrow 1.
2. Rotate the locking ring anticlockwise (as arrow 2 shows).

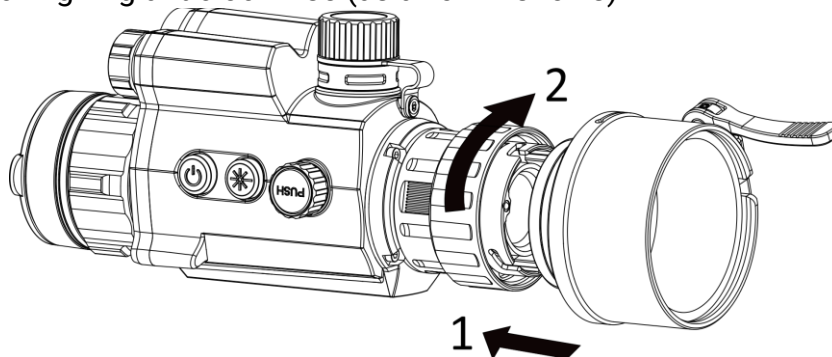

Figure 2-2 Install Adapter

## Note

- The selectable types of the adapter are 38, 40, 50, and 62.
  - Please purchase the adapter separately.
- 

## 2.3 Remove Adapter

### Steps

1. Rotate only the locking ring clockwise, and make sure the device or other parts of the adapter are not rotated or moved.
2. Plug out the adapter after it is loosen.

## 2.4 Install Battery

### 2.4.1 Battery Instruction

- Charge the battery for 4 hours before the first use.
- Remove the battery from the battery compartment if the device is not used for a long time.
- The battery size is 19 mm × 70 mm. The rated voltage is 3.6 VDC, and the battery capacity is 3200 mAh.

### 2.4.2 Battery Installation

Insert the batteries into the battery compartment.

#### Steps

1. Turn the battery cover anticlockwise to loosen it.

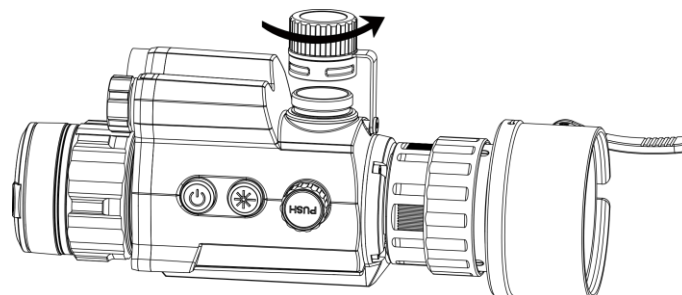
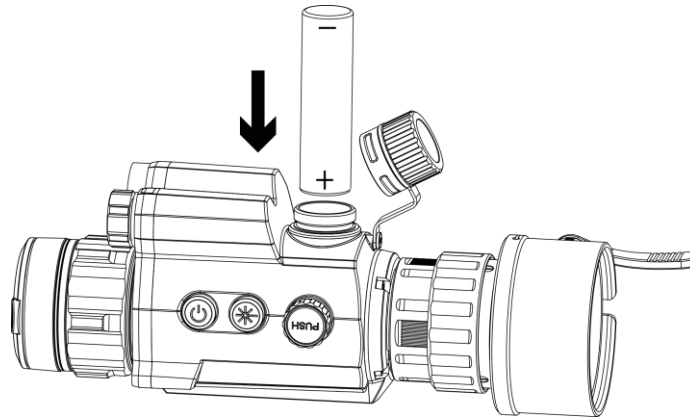

Figure 2-3 Open Battery Cover



2. Insert the battery into the battery compartment with the positive mark inward.



**Figure 2-4 Install Battery**

3. Turn the battery cover clockwise to tighten it.

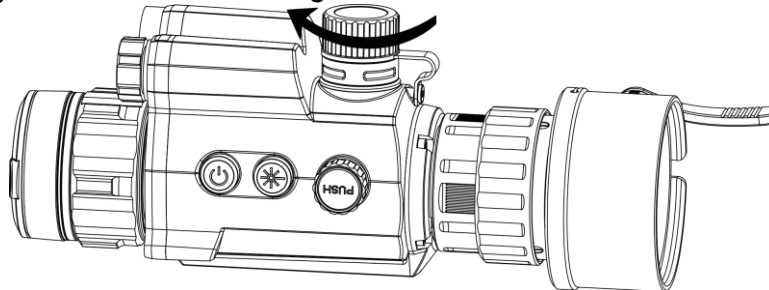

**Figure 2-5 Close Battery Cover**

## 2.5 Power On/Off

### Power On

When the battery is sufficiently charged, hold  to power on the device.



### Power Off

When the device is turned on, hold  to power off the device.



### Auto Power Off

Set the auto power off time for your device, and then the device will automatically shut down as the set time.

#### Steps

1. In the menu, select  **General Settings**, and press the wheel to confirm.
2. Rotate the wheel to select .
3. Press and rotate the wheel to the auto power-off time as required.
4. Hold the wheel to save and exit.

## Note

- See the battery icon for the battery status.  means the battery is fully charged, and  means that the battery is low.
  - When the low power note shows, charge the battery.
  - The auto power off takes effect only when the device enters the standby mode and the device isn't connected with HIKMICRO Sight app at the same time.
  - The auto power off countdown will start again when the device reenters standby mode, or the device is restarted.
- 

## 2.6 Menu Description

When the device is turned on, hold the wheel to show the menu.

In the menu, you can rotate the wheel to select functions, press the wheel to configure the selected function, and hold the wheel to exit the menu.

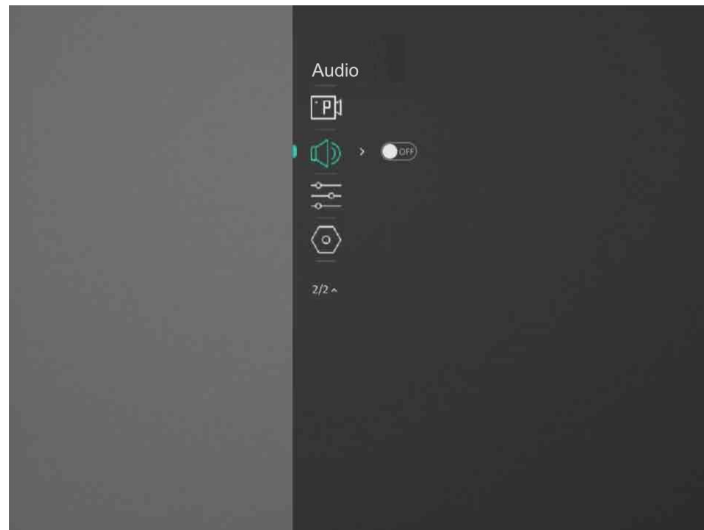

Figure 2-6 Menu Interface

## 2.7 App Connection

Connect the device to the HIKMICRO Sight App via hotspot, then you can capture picture, record video, or configure parameters on your phone.

### Steps

1. Search the HIKMICRO Sight on App Store (iOS System) or Google Play™ (Android System) to download it, or scan the QR code to download and install the app.



Android System



iOS System

2. In the menu, rotate the wheel to select  .
3. Press and rotate the wheel to select **Hotspot**.
4. Turn on the WLAN of your phone and connect to the hotspot.
  - Hotspot Name: HIK-IPTS Serial No.
  - Hotspot Password: Serial No.
5. Open the app and connect your phone with the device. You can view the interface of device on your phone.

---

### Note

- The device cannot connect to the app if you enter wrong password several times. Refer to **Restore Device** to reset the device, and connect the app again.
  - The device should be activated for the first use. The default password must be changed after the activation.
- 

## 2.8 Firmware Status

### 2.8.1 Check Firmware Status

#### Steps

1. Open HIKMICRO Sight and connect your device to the app.
2. Check if there is a red spot on the connection interface. Check if there is an upgrade prompt on the device management interface. If there is no upgrade prompt, the firmware is the latest version. Otherwise, the firmware is not the latest version.

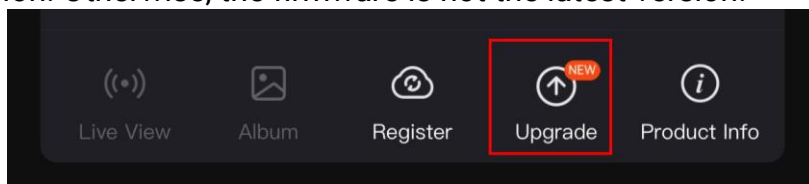

Figure 2-7 Check Firmware Status

3. (Optional) If the firmware is not the latest version, upgrade the device. See *Upgrade Device*.

### 2.8.2 Upgrade Device

#### Upgrade Device via HIKMICRO Sight

##### Before You Start

Install HIKMICRO Sight on your phone and connect your device to the app.

##### Steps

1. Tap the upgrade prompt to enter the firmware upgrade interface.
2. Tap **Upgrade** to start upgrade.

---

##### Note

The upgrading operation may vary due to app updates. Please take the actual app version for reference.

---

#### Upgrade Device via PC

##### Before You Start

- Please get the upgrade package first.
- Turn on the device after connecting it to your PC, and keep the device on for 10 to 15 seconds before other operations.

##### Steps

1. Connect the device to your PC with cable, and then turn on the device.
2. Open the detected disk, copy the upgrade file and paste it to the root directory of the device.
3. Hold  to reboot the device, and the device upgrades automatically. The upgrading process will be displayed in the main interface.

---

##### Note

During the upgrade package transmission, make sure the device is connected to your PC. Otherwise, it may cause unnecessary upgrade failure, firmware damage, etc.

---

### 2.9 Calibrate Image

You can adjust and save the position of the image window for different users. See

*Calibrate Image* for detailed instructions.

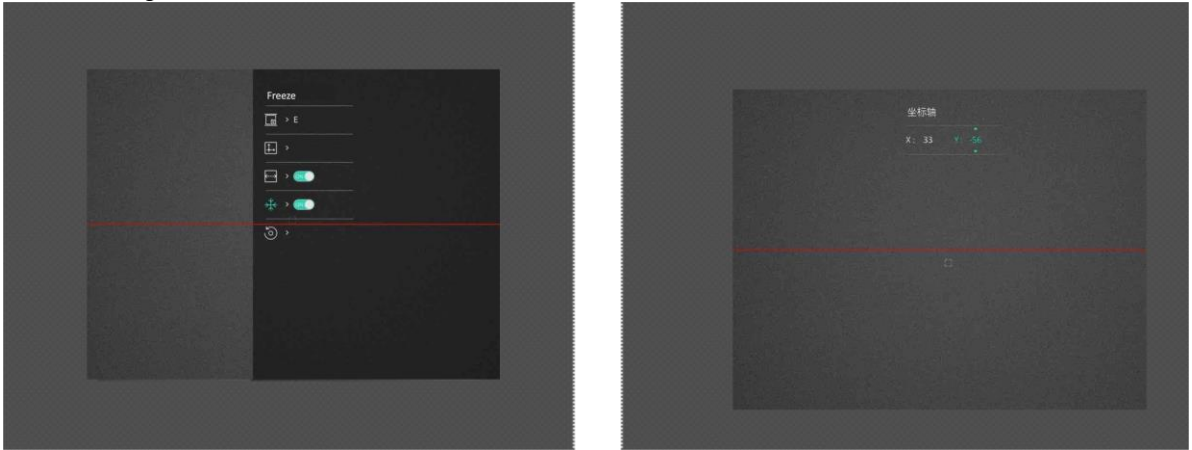

Figure 2-8 Image Calibration Effect

## Chapter 3 Image Settings

### 3.1 Adjust Focus

#### Steps

1. Power on the device.
2. Hold the device and make sure the eyepiece covers your eye.
3. Adjust the focus ring until the image is clear.

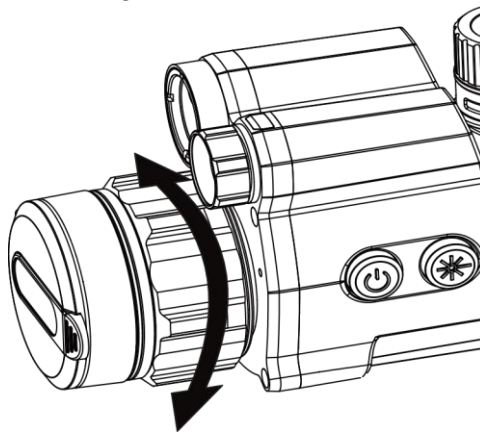

Figure 3-1 Adjust Focus

---

#### Note

When focusing, do not touch the surface of lens to avoid smearing the lens.

---

### 3.2 Adjust Brightness

#### Steps

1. In the menu, select , and press the wheel to confirm.
2. Rotate the wheel to adjust brightness.
3. Hold the wheel to save and exit.

### 3.3 Adjust Contrast

#### Steps

1. In the menu, select , and press the wheel to confirm.
2. Rotate the wheel to adjust contrast.
3. Hold the wheel to save and exit.

### 3.4 Set Display Mode

You can select different display modes in different scenes.

Hold  in live view interface to switch display modes. Day, night, defog, and auto are selectable.

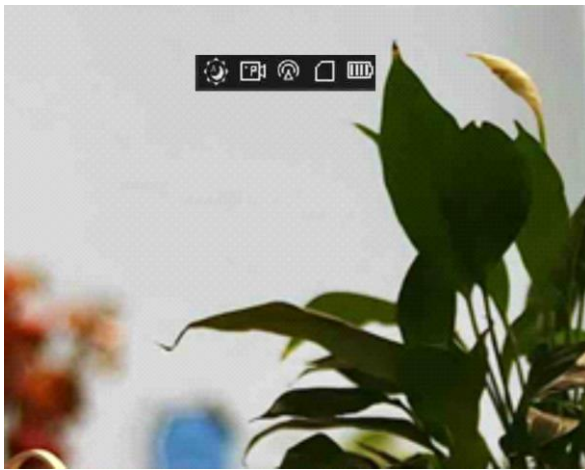

Figure 3-2 Display Mode



Day



Night



Auto







Defog

### 3.5 Calibrate Image

You can adjust and save the position of the image window for different users.

#### Steps

1. In the menu, select .
2. Select , and press and rotate the wheel to switch calib. profiles. You can set 5 calib. profiles.
3. Select , and press the wheel to enable reference line. Make sure the reference line is horizontal in the screen.
4. (Optional) Select , and press the wheel to freeze the image.
5. Select , and press the wheel to start calibration.

6. Press the wheel to select **X** or **Y** axis, and rotate the wheel to set the coordinates until the window reaches the target position.

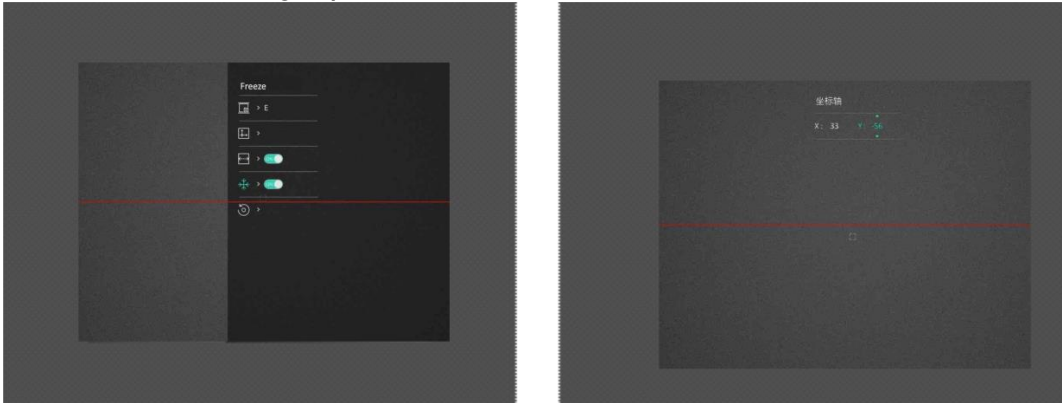



Figure 3-3 Actual Image Calibration Effect

7. (Optional) Select , and press the wheel to confirm. Press **OK** to restore the view to default position, and **CANCEL** to return to the setting interface according to the prompt.

---

### Note

The default position of image window may not be exactly at zero ( $X = 0, Y = 0$ ). This is caused by slight individual differences of optical components, and it is a normal phenomenon.

---

8. Hold the wheel to exit image calibration.





## Chapter 4 Measure Distance

The device can detect the distance between the target and the observation position with laser.

### Before You Start

When measuring the distance, keep the hand and the position steady. Otherwise, the accuracy may be affected.

### Steps

1. In the menu, rotate the wheel to select , and press the wheel to confirm.
2. Rotate the wheel to select a laser ranging mode. The device measures the distance continuously, and the measurement duration can be selected. The measurement result will be refreshed every 1 s.
- 3 Hold the wheel to return to the live view interface.
- 4 Aim the cursor at the target and press  to measure the target distance.

### Result

The distance measurement result is displayed at the upper center of the image.

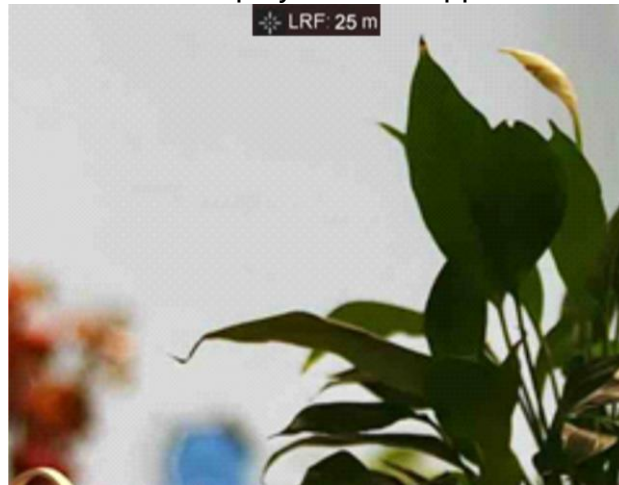



Figure 4-1 Distance Measurement Result

## Chapter 5 General Settings

### 5.1 Set OSD

You can choose whether to display the OSD information on the live view mode in this function.



#### Steps

1. In menu, select  **Function Settings** and press the wheel to confirm.
2. Rotate the wheel to select , and press the wheel to enter the setting interface.
3. Rotate the wheel to select **OSD** and press the wheel to enable it.
4. Rotate the wheel to select **Date** or **Time**, and press the wheel to display or hide the information.
5. Hold the wheel to save and exit.

### 5.2 Set Brand Logo

You can add brand logo on the live view interface.

#### Steps

1. In the menu, select  **Function Settings**, and press the wheel to enter the sub-menu.
2. Rotate the wheel to select , and press the wheel to enable **Brand Logo**.
3. Hold the wheel to save the settings and exit.

#### Result

The brand logo is displayed at the bottom left of the image.

### 5.3 Capture Picture

In the main live view interface, press  and wheel at the same time to capture images.

---

#### Note

When capturing succeeds, the image freezes for 1 second and a prompt shows on the display.

For exporting captured pictures, refer to *Export Files*.

---

### 5.4 Set Audio

If you enable the audio function, the sound will be recorded with the video. When there is too loud noise in the video, you can disable this function.

#### Steps

1. In the menu, rotate the wheel to select .
2. Press the wheel to enable this function.
3. Hold the wheel to save and exit.

### 5.5 Record Video

In the live view interface, press the wheel to start recording, and press the wheel again to stop recording.

---

#### Note

The recording time is displayed at left top of the image. For exporting recording files, refer to *Export Files*.

---

### 5.6 Prerecord Video

After you enable this function and select the prerecording time, the device can automatically start recording the 7, 10 or 15 seconds before the recoil-activation and end recording the 7, 10 or 15 seconds after the recoil-activation.

#### Steps

1. In the menu, select , and press the wheel to confirm.
2. Rotate the wheel to switch the prerecording time. 7 s, 10 s, and 15 s are selectable.
3. Hold the wheel to save and exit.

---

#### Note

If you activate recoils continuously, the device will start recording the 7, 10 or 15 seconds before the first recoil and end recording the 7, 10, or 15 seconds after the last recoil.

---

#### What to do next

For exporting recording files, refer to *Export Files*.

## 5.7 Export Files

### 5.7.1 Export Files via HIKMICRO Sight

You can access device albums and export files to your phone via HIKMICRO Sight.

#### Before You Start

Install HIKMICRO Sight on your mobile phone.

#### Steps

1. Open HIKMICRO Sight and connect your device to the app. See *App Connection*.
2. Tap **Media** to access device albums.

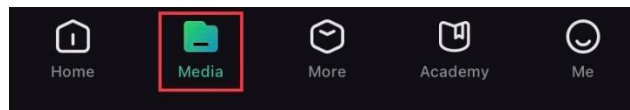

Figure 6-1 Access Device Albums

3. Tap **Local** or **Device** to view the photos and videos.
  - **Local**: You can view the previous files on the app.
  - **Device**: You can view the files of the current device.

---

#### Note

The photos or videos may not show in **Device**. Please pull down to refresh the page.

---

4. Tap to select a file, and tap **Download** to export the file to your local phone albums.



---

#### Note

- Go to **Me > About > User Manual** on the app to see more detailed operations.
- You can also access device albums by tapping bottom left icon in the live view interface.

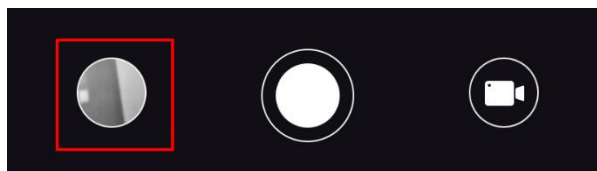

- The exporting operation may vary due to app updates. Please take the actual app

version for reference.

---

### 5.7.2 Export Files via PC

This function is used to export recorded videos and captured pictures.

#### Steps

1. Connect the device and PC with a Type-C cable.
- 

#### Note

Make sure the device is turned on when connecting the cable.

---

2. Open computer disk and select the disk of device. Go to the **DCIM** folder and find the folder named after the capture year and month. For example, if you capture a picture or record a video on June 2021, go to **DCIM > 202106** to find the picture or video.
  3. Select and copy the files to PC.
  4. Disconnect the device from your PC.
- 



#### Note

- The device displays images when you connect it to PC, but functions such as recording, capturing and hotspot are disabled.
  - When you connect the device to PC for the first time, it installs the drive program automatically.
-

## Chapter 6 System Settings



### 6.1 Adjust Date

#### Steps

1. In the menu, select  **General Settings**, and press the wheel to enter the sub-menu.
2. Select .
3. Press the wheel to select the year, month, or day, and rotate the wheel to change the number.
4. Hold the wheel to save settings and exit.

### 6.2 Synchronize Time



#### Steps

1. In the menu, select  **General Settings**, and press the wheel to enter the sub-menu.
2. Select .
3. Press and rotate the wheel to switch the clock system. 24-hour and 12-hour clock are selectable. If you select 12-hour clock, press and rotate the wheel to select AM or PM.
4. Press the wheel to select the hour or minute, and rotate the wheel to change the number.
5. Hold the wheel to save settings and exit.

### 6.3 Set Language

You can select the device language in this function.



#### Steps

1. In the menu, select  **General Settings**, and press the wheel to enter the sub-menu.
2. Select , and press the wheel to enter the language configuration interface.
3. Rotate the wheel to select the language as required, and press the wheel to confirm.
4. Hold the wheel to exit.



## 6.4 Set Unit

You can switch the unit for the distance measurement function.

### Steps



1. In the menu, select  **General Settings**, and press the wheel to enter the sub-menu.
2. Select , and press the wheel to confirm.
3. Rotate the wheel to select **yard** or **m**.
4. Hold the wheel to save settings and exit.

## 6.5 View Device Information

1. In the menu, select  **General Settings**, and press the wheel to enter the sub-menu.
2. Select , and press the wheel. You can view the device information such as version, and serial No.

## 6.6 Restore Device

### Steps

1. In the menu, select  **General Settings**, and press the wheel to enter the sub-menu.
2. Select , and press the wheel to restore the device to defaults according to the prompt.

## Chapter 7 Frequently Asked Questions

### 7.1 Why is the monitor off?

Check the following items.

- Check whether the device is off-battery.
- Check the monitor after charging the device for 5 minutes.

### 7.2 The image is not clear, how to adjust it?

Adjust the focus ring until the image is clear. Refer to *Adjust Focus*.

### 7.3 Capturing or recording fails. What's the problem?

Check the following items.

- Whether the device is connected to your PC. Capturing or recording is disabled in this status.
- Whether the storage space is full.
- Whether the device is low-battery.

### 7.4 Why the PC cannot identify the device?

Check the following items.

- Whether the device is connected to your PC with supplied USB cable.
- If you use other USB cables, make sure the cable length is no longer than 1 m.



## Safety Instruction



These instructions are intended to ensure that user can use the product correctly to avoid danger or property loss.

### Laws and Regulations

Use of the product must be in strict compliance with the local electrical safety regulations.

### Symbol Conventions

The symbols that may be found in this document are defined as follows.

Symbol	Description
 <b>Danger</b>	Indicates a hazardous situation which, if not avoided, will or could result in death or serious injury.
 <b>Caution</b>	Indicates a potentially hazardous situation which, if not avoided, could result in equipment damage, data loss, performance degradation, or unexpected results.
 <b>Note</b>	Provides additional information to emphasize or supplement important points of the main text.

### Transportation

- Keep the device in original or similar packaging while transporting it.
- Keep all wrappers after unpacking them for future use. In case of any failure occurred, you need to return the device to the factory with the original wrapper. Transportation without the original wrapper may result in damage on the device and the company shall not take any responsibilities.
- DO NOT drop the product or subject it to physical shock. Keep the device away from magnetic interference.

### Power Supply

- Please purchase the adapter by yourself. Input voltage should meet the Limited Power Source (5 VDC, 2A) according to the IEC62368 standard. Please refer to technical specifications for detailed information.
- Use the power adapter provided by qualified manufacturer. Refer to the product specification for detailed power requirements.
- Make sure the plug is properly connected to the power socket.
- DO NOT connect multiple devices to one power adapter, to avoid over-heating or fire hazards caused by overload.
- The battery charger is included in the package. The input voltage for the supplied battery

charger should meet the Limited Power Source (5 VDC, 2 A).

- The power source should meet limited power source or PS2 requirements according to IEC 62368-1 standard.

### Battery

- Improper use or replacement of the battery may result in explosion hazard. Replace with the same or equivalent type only.
- The battery type is 18650 with the protection board. The battery size is 19 mm × 70 mm. The rated voltage is 3.6 VDC, and the battery capacity is 3200 mAh. Dispose of used batteries in conformance with the instructions provided by the battery manufacturer.
- Make sure the battery temperature is between 0 °C to 45 °C (32 °F to 113 °F) when charging.
- For long-term storage of the battery, make sure it is fully charged every half year to ensure the battery quality. Otherwise, damage may occur.
- Do not charge other battery types with the supplied charger. Confirm there is no flammable material within 2 m of the charger during charging.
- DO NOT place the battery near heating or fire source. Avoid direct sunlight.
- DO NOT swallow the battery to avoid chemical burns.
- DO NOT place the battery in the reach of children.
- The battery cannot be charged with external power source directly.
- The device cannot be charged, please use the supplied charger to charge the battery.
- Please purchase the adapter by yourself. The using environment of the adapter should be consistent with that of the device.

### Maintenance

- If the product does not work properly, please contact your dealer or the nearest service center. We shall not assume any responsibility for problems caused by unauthorized repair or maintenance.
- Wipe the device gently with a clean cloth and a small quantity of ethanol, if necessary.
- If the equipment is used in a manner not specified by the manufacturer, the protection provided by the device may be impaired.
- Clean the lens with soft and dry cloth or wiping paper to avoid scratching it.

### Using Environment

- Make sure the running environment meets the requirement of the device. The operating temperature shall be -30°C to 55°C (-22°F to 131°F), and the operating humidity shall be 95% or less.
- DO NOT expose the device to extremely hot, cold, dusty, corrosive, saline-alkali, or damp environments.
- Avoid equipment installation on vibratory surface or places subject to shock (neglect may cause equipment damage).

- DO NOT aim the lens at the sun or any other bright light.

### Emergency

- If smoke, odor, or noise arises from the device, immediately turn off the power, unplug the power cable, and contact the service center.

### Laser

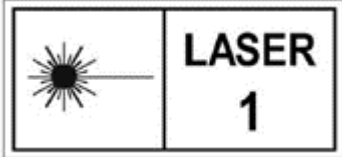

When any laser equipment is in use, make sure that the device lens is not exposed to the laser beam, or it may burn out. The laser radiation emitted from the device can cause eye injuries, burning of skin or inflammable substances. Before enabling the laser ranging function, make sure no human or inflammable substances are in front of the laser lens. Do not place the device where minors can fetch it. The wavelength is 905 nm, and the max. power output is less than 1.328 mW. According to IEC 60825-1:2014 and EN 60825-1:2014+A11:2021, this laser product is classified as Class 1 laser product.

### Manufacture Address

Room 313, Unit B, Building 2, 399 Danfeng Road, Xixing Subdistrict, Binjiang District,  
Hangzhou, Zhejiang 310052, China  
Hangzhou Microimage Software Co., Ltd.

## Legal Information

©2023 Hangzhou Microimage Software Co., Ltd. All rights reserved.

### About this Manual

The Manual includes instructions for using and managing the Product. Pictures, charts, images and all other information hereinafter are for description and explanation only. The information contained in the Manual is subject to change, without notice, due to firmware updates or other reasons. Please find the latest version of this Manual at the HIKMICRO website (<http://www.hikmicrotech.com>).

Please use this Manual with the guidance and assistance of professionals trained in supporting the Product.

### Trademarks

 **HIKMICRO** and other HIKMICRO's trademarks and logos are the properties of HIKMICRO in various jurisdictions. Other trademarks and logos mentioned are the properties of their respective owners.

### Disclaimer

TO THE MAXIMUM EXTENT PERMITTED BY APPLICABLE LAW, THIS MANUAL AND THE PRODUCT DESCRIBED, WITH ITS HARDWARE, SOFTWARE AND FIRMWARE, ARE PROVIDED "AS IS" AND "WITH ALL FAULTS AND ERRORS". HIKMICRO MAKES NO WARRANTIES, EXPRESS OR IMPLIED, INCLUDING WITHOUT LIMITATION, MERCHANTABILITY, SATISFACTORY QUALITY, OR FITNESS FOR A PARTICULAR PURPOSE. THE USE OF THE PRODUCT BY YOU IS AT YOUR OWN RISK. IN NO EVENT WILL HIKMICRO BE LIABLE TO YOU FOR ANY SPECIAL, CONSEQUENTIAL, INCIDENTAL, OR INDIRECT DAMAGES, INCLUDING, AMONG OTHERS, DAMAGES FOR LOSS OF BUSINESS PROFITS, BUSINESS INTERRUPTION, OR LOSS OF DATA, CORRUPTION OF SYSTEMS, OR LOSS OF DOCUMENTATION, WHETHER BASED ON BREACH OF CONTRACT, TORT (INCLUDING NEGLIGENCE), PRODUCT LIABILITY, OR OTHERWISE, IN CONNECTION WITH THE USE OF THE PRODUCT, EVEN IF HIKMICRO HAS BEEN ADVISED OF THE POSSIBILITY OF SUCH DAMAGES OR LOSS.

YOU ACKNOWLEDGE THAT THE NATURE OF THE INTERNET PROVIDES FOR INHERENT SECURITY RISKS, AND HIKMICRO SHALL NOT TAKE ANY RESPONSIBILITIES FOR ABNORMAL OPERATION, PRIVACY LEAKAGE OR OTHER DAMAGES RESULTING FROM CYBER-ATTACK, HACKER ATTACK, VIRUS INFECTION, OR OTHER INTERNET SECURITY RISKS; HOWEVER, HIKMICRO WILL PROVIDE TIMELY TECHNICAL SUPPORT IF REQUIRED. YOU AGREE TO USE THIS PRODUCT IN COMPLIANCE WITH ALL APPLICABLE LAWS, AND YOU ARE SOLELY RESPONSIBLE FOR ENSURING THAT YOUR USE CONFORMS TO THE

## Digital Night Vision Monocular User Manual

---

APPLICABLE LAW. ESPECIALLY, YOU ARE RESPONSIBLE, FOR USING THIS PRODUCT IN A MANNER THAT DOES NOT INFRINGE ON THE RIGHTS OF THIRD PARTIES, INCLUDING WITHOUT LIMITATION, RIGHTS OF PUBLICITY, INTELLECTUAL PROPERTY RIGHTS, OR DATA PROTECTION AND OTHER PRIVACY RIGHTS. YOU SHALL NOT USE THIS PRODUCT FOR ILLEGAL HUNTING ANIMALS, INVASION OF PRIVACY OR ANY OTHER PURPOSE WHICH IS ILLEGAL OR DETRIMENTAL TO THE PUBLIC INTEREST. YOU SHALL NOT USE THIS PRODUCT FOR ANY PROHIBITED END-USES, INCLUDING THE DEVELOPMENT OR PRODUCTION OF WEAPONS OF MASS DESTRUCTION, THE DEVELOPMENT OR PRODUCTION OF CHEMICAL OR BIOLOGICAL WEAPONS, ANY ACTIVITIES IN THE CONTEXT RELATED TO ANY NUCLEAR EXPLOSIVE OR UNSAFE NUCLEAR FUEL-CYCLE, OR IN SUPPORT OF HUMAN RIGHTS ABUSES.

PLEASE FOLLOW ALL THE PROHIBITIONS AND EXCEPTIONAL CAVEATS OF ALL APPLICABLE LAWS AND REGULATIONS, IN PARTICULAR, THE LOCAL FIREARMS AND/OR HUNTING LAWS AND REGULATIONS. PLEASE ALWAYS CHECK NATIONAL PROVISIONS AND REGULATIONS BEFORE PURCHASE OR USE OF THIS PRODUCT. PLEASE NOTE THAT YOU MAY HAVE TO APPLY FOR PERMITS, CERTIFICATES, AND/OR LICENSES BEFORE ANY PURCHASING, SELLING, MARKETING AND/OR USING OF THE PRODUCT. HIKMICRO SHALL NOT BE LIABLE FOR ANY SUCH ILLEGAL OR IMPROPER PURCHASING, SELLING, MARKETING, AND END USES AND ANY SPECIAL, CONSEQUENTIAL, INCIDENTAL, OR INDIRECT DAMAGES ARISING THEREOF.

IN THE EVENT OF ANY CONFLICTS BETWEEN THIS MANUAL AND THE APPLICABLE LAW, THE LATTER PREVAILS.

## Regulatory Information

---

These clauses apply only to the products bearing the corresponding mark or information.

---

### FCC Information

Please take attention that changes or modification not expressly approved by the party responsible for compliance could void the user's authority to operate the equipment.

Note: This product has been tested and found to comply with the limits for a Class B digital device, pursuant to Part 15 of the FCC Rules. These limits are designed to provide reasonable protection against harmful interference in a residential installation. This product generates, uses, and can radiate radio frequency energy and, if not installed and used in accordance with the instructions, may cause harmful interference to radio communications. However, there is no guarantee that interference will not occur in a particular installation. If this product does cause harmful interference to radio or television reception, which can be determined by turning the equipment off and on, the user is encouraged to try to correct the interference by one or more of the following measures:

- Reorient or relocate the receiving antenna.
- Increase the separation between the equipment and receiver.
- Connect the equipment into an outlet on a circuit different from that to which the receiver is connected.
- Consult the dealer or an experienced radio/TV technician for help.

Please take attention that changes or modification not expressly approved by the party responsible for compliance could void the user's authority to operate the equipment.

This device complies with Part 15 of the FCC Rules. Operation is subject to the following two conditions:

- (1) This device may not cause harmful interference, and
- (2) This device must accept any interference received, including interference that may cause undesired operation.

Note: Due to the device size limit, the above statement may not be disclaimed on the device.

This equipment complies with FCC radiation exposure limits set forth for an uncontrolled environment.

### EU Compliance Statement



This product and - if applicable - the supplied accessories too are marked with "CE" and comply therefore with the applicable harmonized European standards listed under the Directive 2014/30/EU (EMCD), Directive

2014/35/EU (LVD), Directive 2011/65/EU (RoHS), Directive 2014/53/EU.

Hereby, Hangzhou Microimage Software Co., Ltd. declares that this device (refer to the label) is in compliance with Directive 2014/53/EU.

The full text of the EU declaration of conformity is available at the following internet address:

<https://www.hikmicrotech.com/en/support/download-center/declaration-of-conformity/>

### Frequency Bands and Power (for CE)

The frequency bands and modes and the nominal limits of transmitted power (radiated and/or conducted) applicable to this radio device are the following: Wi-Fi 2.4 GHz (2.4 GHz to 2.4835 GHz), 20 dBm.



Directive 2012/19/EU (WEEE Directive): Products marked with this symbol cannot be disposed of as unsorted municipal waste in the European Union. For proper recycling, return this product to your local supplier upon the purchase of equivalent new equipment, or dispose of it at designated collection points. For more information see: [www.recyclethis.info](http://www.recyclethis.info).



Directive 2006/66/EC and its amendment 2013/56/EU (Battery Directive): This product contains a battery that cannot be disposed of as unsorted municipal waste in the European Union. See the product documentation for specific battery information. The battery is marked with this symbol, which may include lettering to indicate cadmium (Cd), lead (Pb), or mercury (Hg). For proper recycling, return the battery to your supplier or to a designated collection point. For more information see: [www.recyclethis.info](http://www.recyclethis.info).

### Industry Canada ICES-003 Compliance

This device meets the CAN ICES-003 (B)/NMB-003(B) standards requirements.

This device complies with Industry Canada license-exempt RSS standard(s). Operation is subject to the following two conditions:

- (1) this device may not cause interference, and
- (2) this device must accept any interference, including interference that may cause undesired operation of the device.

This equipment complies with IC RSS-102 radiation exposure limits set forth for an uncontrolled environment.

### Conformité Industrie Canada ICES-003

Cet appareil répond aux exigences des normes CAN ICES-003 (B)/NMB-003 (B).

Cet appareil est conforme aux normes RSS exemptes de licence d'Industrie Canada. Son fonctionnement est soumis aux deux conditions suivantes :

- (1) cet appareil ne doit pas causer d'interférences, et

(2) cet appareil doit accepter toute interférence reçue, notamment les interférences susceptibles d'occasionner un fonctionnement indésirable de l'appareil.

Cet appareil est conforme aux limites d'exposition au rayonnement IC RSS-102 établies pour un environnement non contrôlé.

### INFORMATIONEN FÜR PRIVATE HAUSHALTE

#### 1. Getrennte Erfassung von Altgeräten:

Elektro- und Elektronikgeräte, die zu Abfall geworden sind, werden als Altgeräte bezeichnet. Besitzer von Altgeräten haben diese einer vom unsortierten Siedlungsabfall getrennten Erfassung zuzuführen. Altgeräte gehören insbesondere nicht in den Hausmüll, sondern in spezielle Sammel- und Rückgabesysteme.

#### 2. Batterien und Akkus sowie Lampen:

Besitzer von Altgeräten haben Altbatterien und Altakkumulatoren, die nicht vom Altgerät umschlossen sind, die zerstörungsfrei aus dem Altgerät entnommen werden können, im Regelfall vor der Abgabe an einer Erfassungsstelle vom Altgerät zu trennen. Dies gilt nicht, soweit Altgeräte einer Vorbereitung zur Wiederverwendung unter Beteiligung eines öffentlich-rechtlichen Entsorgungsträgers zugeführt werden.

#### 3. Möglichkeiten der Rückgabe von Altgeräten:

Besitzer von Altgeräten aus privaten Haushalten können diese bei den Sammelstellen der öffentlich-rechtlichen Entsorgungsträger oder bei den von Herstellern oder Vertreibern im Sinne des ElektroG eingerichteten Rücknahmestellen unentgeltlich abgeben.

Rücknahmepflichtig sind Geschäfte mit einer Verkaufsfläche von mindestens 400 m<sup>2</sup> für Elektro- und Elektronikgeräte sowie diejenigen Lebensmittelgeschäfte mit einer Gesamtverkaufsfläche von mindestens 800 m<sup>2</sup>, die mehrmals pro Jahr oder dauerhaft Elektro- und Elektronikgeräte anbieten und auf dem Markt bereitstellen. Dies gilt auch bei Vertrieb unter Verwendung von Fernkommunikationsmitteln, wenn die Lager- und Versandflächen für Elektro- und Elektronikgeräte mindestens 400 m<sup>2</sup> betragen oder die gesamten Lager- und Versandflächen mindestens 800 m<sup>2</sup> betragen. Vertreter haben die Rücknahme grundsätzlich durch geeignete Rückgabemöglichkeiten in zumutbarer Entfernung zum jeweiligen Endnutzer zu gewährleisten. Die Möglichkeit der unentgeltlichen Rückgabe eines Altgerätes besteht bei rücknahmepflichtigen Vertreibern unter anderem dann, wenn ein neues gleichartiges Gerät, das im Wesentlichen die gleichen Funktionen erfüllt, an einen Endnutzer abgegeben wird.

#### 4. Datenschutz-Hinweis:

Altgeräte enthalten häufig sensible personenbezogene Daten. Dies gilt insbesondere für Geräte der Informations- und Telekommunikationstechnik wie Computer und Smartphones. Bitte beachten Sie in Ihrem eigenen Interesse, dass für die Löschung der Daten auf den zu entsorgenden Altgeräten jeder Endnutzer selbst verantwortlich ist.

#### 5. Bedeutung des Symbols „durchgestrichene Mülltonne“:





Das auf Elektro- und Elektronikgeräten regelmäßig abgebildete Symbol einer durchgestrichenen Mülltonne weist darauf hin, dass das jeweilige Gerät am Ende seiner Lebensdauer getrennt vom unsortierten Siedlungsabfall zu erfassen ist.

### KC

B급 기기: 이 기기는 가정용(B급) 전자파적합기기로서 주로 가정에서 사용하는 것을 목적으로 하며, 모든 지역에서 사용할 수 있습니다.



# HIKMICRO

See the World in a New Way



Facebook: HIKMICRO Outdoor Instagram: hikmicro\_outdoor

YouTube: HIKMICRO Outdoor

LinkedIn: HIKMICRO

Website: [www.hikmicrotech.com](http://www.hikmicrotech.com)

E-mail: [support@hikmicrotech.com](mailto:support@hikmicrotech.com)

UD35987B