



# Thermal Image Scope

## STELLAR Series

User Manual V5.5.61 202312



Contact Us

## CONTENTS

Chapter 1 Overview .....	1
1.1 Device Description.....	1
1.2 Main Function .....	1
1.3 Appearance .....	1
Chapter 2 Preparation .....	4
2.1 Cable Connection .....	4
2.2 Install Battery .....	4
2.2.1 Battery Instruction .....	4
2.2.2 Battery Installation .....	5
2.3 Power On/Off .....	6
2.4 Mount Device on Rail .....	6
2.5 Menu Description .....	8
2.6 App Connection .....	9
2.7 Firmware Status .....	10
2.7.1 Check Firmware Status .....	10
2.7.2 Upgrade Device.....	10
2.8 Zeroing (Overview) .....	11
Chapter 3 Image Settings .....	12
3.1 Adjust Diopter .....	12
3.2 Adjust Focus .....	12
3.3 Adjust Brightness .....	13
3.4 Adjust Contrast.....	13
3.5 Adjust Tone.....	13
3.6 Adjust Sharpness .....	14
3.7 Select Scene Mode.....	14
3.8 Set Palettes .....	15
3.9 Flat Field Correction .....	16
3.9 Correct Defective Pixel.....	17
3.11 Adjust Digital Zoom .....	17

3.12 Set Picture in Picture Mode.....	18
Chapter 4 Zeroing.....	20
4.1 Select Zeroing Profile.....	20
4.2 Set Reticle .....	20
4.3 Correct Reticle .....	22
Chapter 5 Measure Distance .....	24
Chapter 6 General Settings.....	26
6.1 Set OSD .....	26
6.4 Capture and Video .....	27
6.4.1 Capture Picture .....	27
6.4.2 Set Audio .....	27
6.4.3 Record Video.....	28
6.4.4 Prerecord Video .....	28
6.5 Hot Tracking .....	29
6.6 Export Files .....	29
6.6.1 Export Files via HIKMICRO Sight.....	29
6.6.2 Export Files via PC.....	30
Chapter 7 System Settings .....	32
7.1 Adjust Date.....	32
7.2 Synchronize Time.....	32
7.3 Language Settings.....	32
7.4 Unit Settings.....	33
7.5 View Device Information.....	33
7.6 Restore Device.....	33
Chapter 8 Frequently Asked Questions .....	34
8.1 Why is the monitor off?.....	34
8.2 The image is not clear, how to adjust it?.....	34
8.3 Capturing or recording fails. What's the problem? .....	34
8.4 Why the PC cannot identify the device? .....	34

# Thermal Image Scope User Manual

---

Safety Instruction .....	35
Legal Information .....	38
Regulatory Information .....	40

# Chapter 1 Overview

## 1.1 Device Description

HIKMICRO STELLAR Thermal Image Scope provides clear image under harsh environment conditions like darkness, fog, smoke, dust, rain, snow, wood, camouflage, etc. The traditional-style scope meets the needs of professional hunters who value traditions and seek technological superiority, ensuring an extreme detection range.

## 1.2 Main Function

- **Distance Measurement:** The device can detect the distance between the target and the observation position.
- **Hot Tracking:** The device can detect the highest temperature in the scene and mark the spot.
- **Zeroing:** The reticle helps you to aim at the target fast and accurately. See **Zeroing**.
- **App Connection:** The device can capture snapshots, record videos, and set parameters by HIKMICRO Sight app after being connected to your phone via hotspot.
- **Image Correction:** The device supports DPC (Defective Pixel Correction) and FFC (Flat Field Correction) which can optimize the image quality.

## 1.3 Appearance

---

### Note

The picture is for reference only. The actual product may vary according to different models.

---

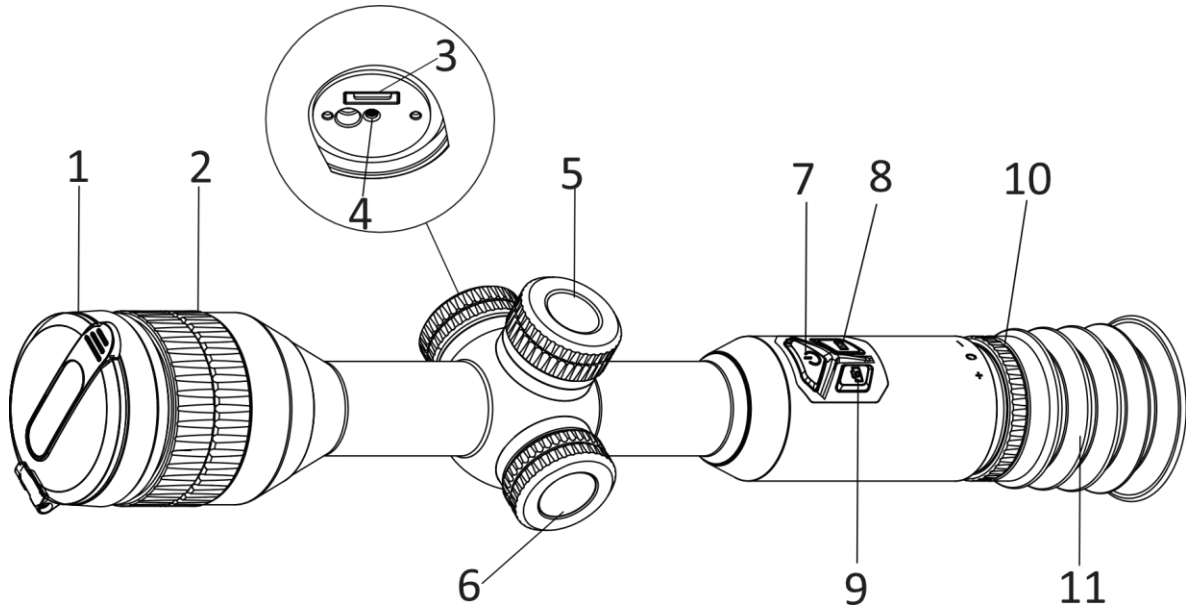

**Figure 1-1 Buttons and Components**

**Table 1-1 Description of Buttons and Components**

No.	Component	Function
1	Lens Cover	Protects the lens.
2	Focus Ring	Adjusts focus to obtain clear targets.
3	Type-C Interface	To connect the device to power supply or transmit data with a type-C cable.
4	Battery Status Indicator	<ul style="list-style-type: none"> <li>● Flashing Red &amp; Green: Error occurred.</li> <li>● Solid Red: Battery is charging.</li> <li>● Solid Green: Battery is fully charged.</li> <li>● Off: Battery is not charged.</li> </ul>
5	Battery Compartment	For holding the battery.
6	Wheel	Non-Menu Mode: <ul style="list-style-type: none"> <li>● Hold: Enter the menu.</li> <li>● Rotate: Switch digital zoom.</li> </ul> Menu Mode: <ul style="list-style-type: none"> <li>● Press: Confirm/Set parameters.</li> <li>● Hold: Exit the menu.</li> <li>● Rotate: Move up/Move down.</li> </ul>
7	Power Key	<ul style="list-style-type: none"> <li>● Press: Standby mode/Wake up device.</li> <li>● Hold: Power on/off.</li> </ul>

## Thermal Image Scope User Manual

---

8	Mode Key	<ul style="list-style-type: none"><li>● Press: Switch palettes.</li><li>● Hold: Correct non-uniformity of display (FFC)</li></ul>
9	Capture Key	<ul style="list-style-type: none"><li>● Press: Capture snapshot.</li><li>● Hold: Start/Stop recording.</li></ul>
8 + 9	Mode + Capture Key	Hold: Lock/unlock the wheel.
10	Diopter Adjustment Ring	Adjusts the dioptic.
11	Eyepiece	The piece placed closest to the eye to view the target.

## Chapter 2 Preparation

### 2.1 Cable Connection

Connect the device and power adapter with a type-C cable to charge the device. Alternatively, connect the device and PC to export files.

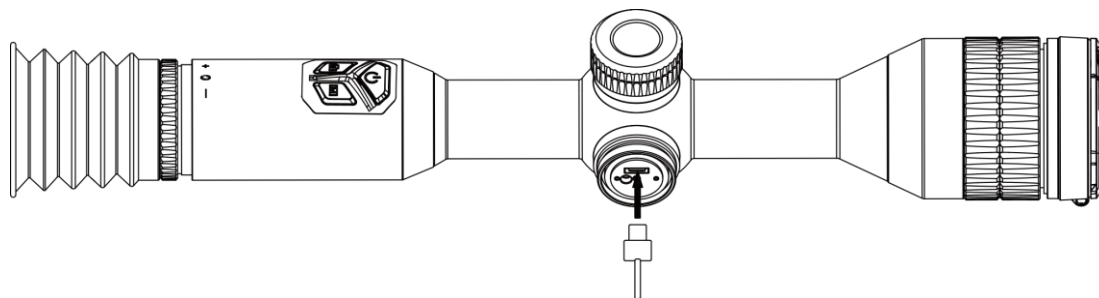

Figure 2-1 Cable Connection

#### Note

Charge the device for more than 4 hours before first use.

### 2.2 Install Battery

#### 2.2.1 Battery Instruction

The device comes with two built-in rechargeable lithium-ion batteries and an external removable non-rechargeable battery. The battery description is shown as follows.

Table 2-1 Battery Description

Battery Type	Rated Voltage	Rated Capacity	Battery Size	Working Temperature
Built-in Rechargeable lithium-ion 18650 battery	3.6 VDC	3350 mAh	23 mm × 67 mm	-20 °C to 60 °C (-4 °F to 140 °F)
External Removable Non-rechargeable CR123A Battery	3 VDC	1600 mAh	16.5 mm × 34 mm	-20 °C to 60 °C (-4 °F to 140 °F)



**Note**

- Do not charge the removable battery in the package.
  - Install the external battery before the built-in battery runs out, or the device cannot be turned on. If such exception occurs accidentally, please charge the device for at least 1 hour.
  - Remove the external battery if the device is not used for a long time.
- 

## 2.2.2 Battery Installation

Insert the battery into the battery compartment.

### Steps

1. Turn the battery cover counterclockwise to loosen it.

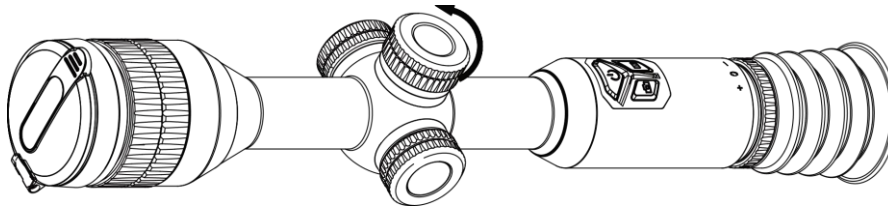

**Figure 2-2 Loosen the Cover**

2. Insert the battery into the battery compartment with the positive mark inward.

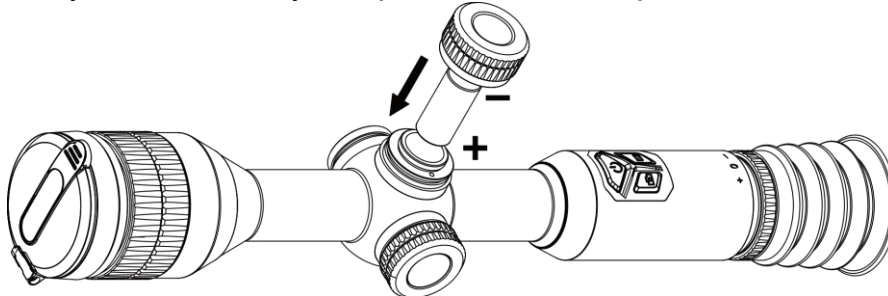

**Figure 2-3 Install the Battery**

3. Turn the battery cover clockwise to tighten it.

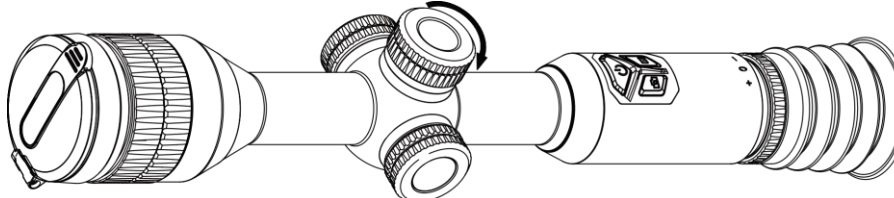

**Figure 2-4 Tighten the Cover**

## 2.3 Power On/Off

### Power On

When the battery is sufficiently charged, hold  to power on the device.

### Power Off

When the device is turned on, hold  to power off the device.

---



### Note

- Power-off countdown will appear when you power off the device. You can press any key to interrupt the countdown and cancel the power-off.
  - Automatic low battery power-off cannot be canceled.
- 



### Auto Power Off

You can set the auto power off time for your device.

### Steps

1. Hold the wheel to go to the menu.
  2. Go to  **General Settings** and select , then rotate the wheel to select the auto power off time as required.
  3. Hold the wheel to save and exit.
- 

### Note

- See the battery icon for the battery status.  means the battery is fully charged,  means that the battery is low, and  means the battery charging is abnormal.
  - When the low power note shows, charge the battery.
  - The auto power off takes effect only when the device enters the standby mode and the device isn't connected with HIKMICRO Sight app at the same time.
  - The auto power off countdown will start again when the device reenters standby mode, or the device is restarted.
- 

## 2.4 Mount Device on Rail

### Steps

1. Unscrew the ring top with Allen wrench.
-

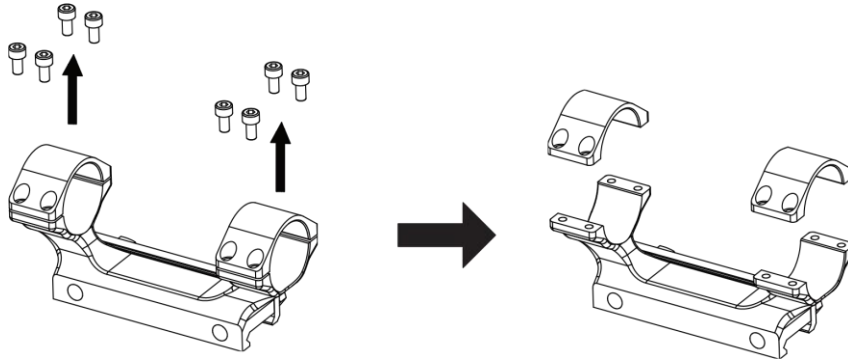

**Figure 2-5 Unscrew the Ring Top**

2. Place the device in the bottom half of the ring, and align the top holes with bottom holes.

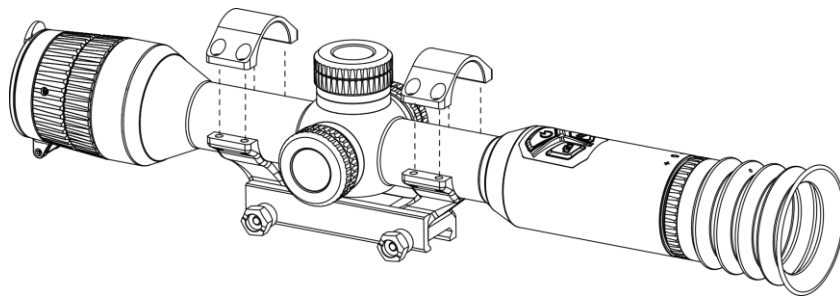

**Figure 2-6 Put the Device in the Ring**

3. Insert and tighten the screws.

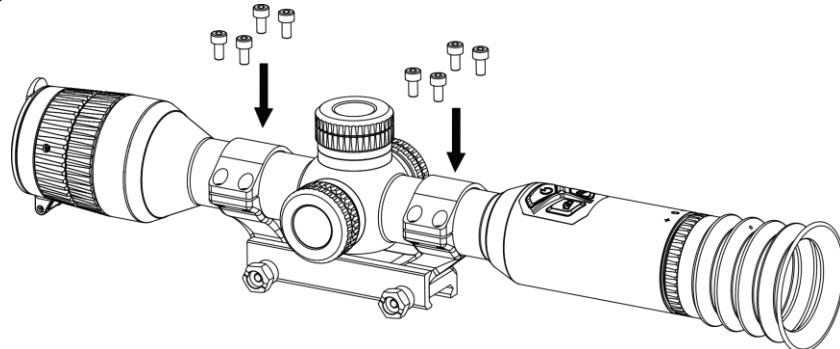

**Figure 2-7 Tighten the Screws**

4. Loosen the screws on the bottom half of the ring.

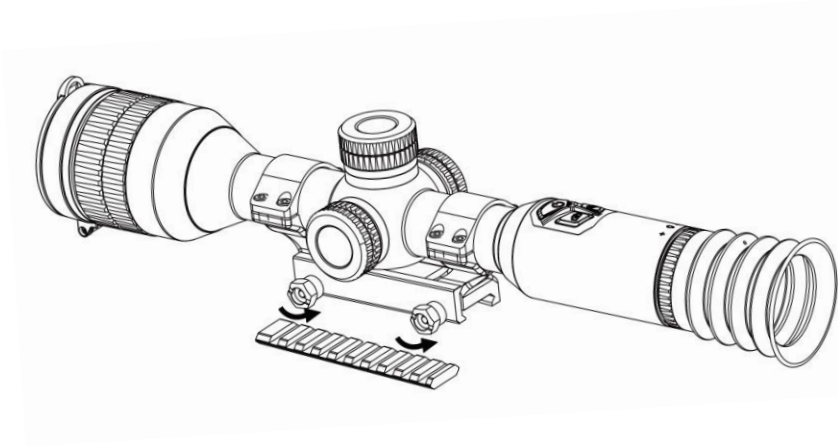

**Figure 2-8 Loosen the Screws**

5. Attach the bottom half of the ring to the rail, and tighten the screws on the ring. Make sure the device stays level.

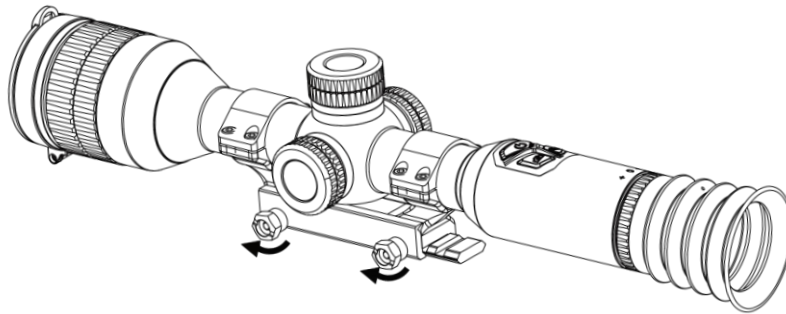

**Figure 2-9 Tighten the Screws**

---

**Note**

- The ring may vary according to different models. Please refer to the actual product.
  - The ring needs to be purchased separately.
  - Use lint-free cloth to clean the device base and the rail.
- 

## 2.5 Menu Description

When the device is turned on, hold the wheel to show the menu.

In the menu, you can rotate the wheel to select functions, press the wheel to configure the selected function, and hold the wheel to exit the menu.

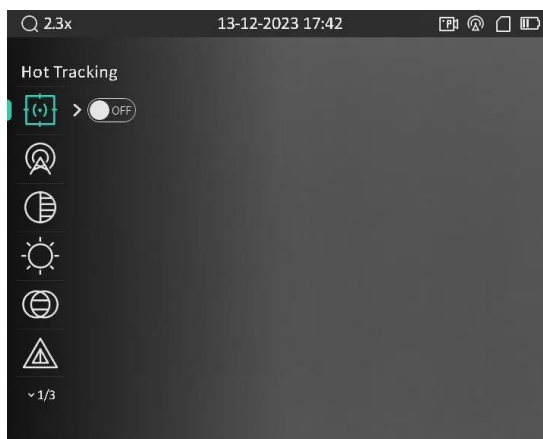

Figure 2-10 Device Menu

## 2.6 App Connection

Connect the device to the HIKMICRO Sight app via hotspot, and then you can capture picture, record video, or configure parameters on your phone.

### Steps

1. Search the HIKMICRO Sight App on App Store (iOS System) or Google Play™ (Android System) to download it, or scan the QR code to download and install the app.



Android System



iOS System

2. Hold the wheel to show the menu.
3. Rotate the wheel to select , and press the wheel to enter the setting interface.
4. Rotate the wheel to select **Hotspot**. The hotspot function is enabled.
5. Turn on the WLAN of your phone and connect to the hotspot.
  - Hotspot Name: HIK-IPTS Serial No.
  - Hotspot Password: Serial No.
6. Open the app and connect your phone with the device. You can view the interface of device on your phone.

---

### Note

The device cannot connect to the app if the wrong password is entered several times. Refer to **Restore Device** to reset the device, and connect the app again.

---

## 2.7 Firmware Status

### 2.7.1 Check Firmware Status

#### Steps

1. Open HIKMICRO Sight and connect your device to the app.
2. Check if there is an upgrade prompt on the device management interface. If there is no upgrade prompt, the firmware is the latest version. Otherwise, the firmware is not the latest version.

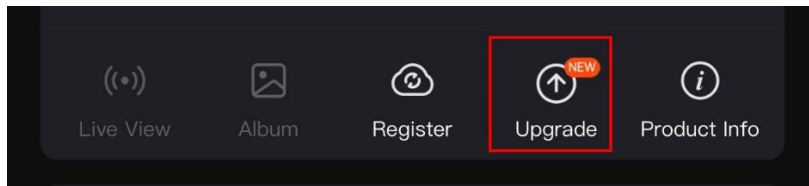

Figure 2-11 Check Firmware Status

3. (Optional) If the firmware is not the latest version, upgrade the device. See **Upgrade Device**.

### 2.7.2 Upgrade Device

#### Upgrade Device via HIKMICRO Sight

#### Steps

1. Open HIKMICRO Sight app and connect your device to the app.
2. Tap the upgrade prompt to enter the firmware upgrade interface.
3. Tap **Upgrade** to start upgrade.

---

#### Note

The upgrading operation may vary due to app updates. Please take the actual app version for reference.

---

#### Upgrade Device via PC

#### Before You Start

Please get the upgrade package first.

#### Steps

1. Connect the device to your PC with cable.
2. Open the detected disk, copy the upgrade file and paste it to the root directory of the device.

3. Disconnect the device from your PC.
4. Reboot the device, and the device upgrades automatically. The upgrading process will be displayed in the main interface.

### **Caution**

During the upgrade package transmission, make sure the device is connected to your PC. Otherwise, it may cause unnecessary upgrade failure, firmware damage, etc.

---

## 2.8 Zeroing (Overview)

You can enable the reticle to view the position of the target. The functions such as freeze and zoom help to adjust the reticle more accurately. See **Zeroing** for detailed instructions.

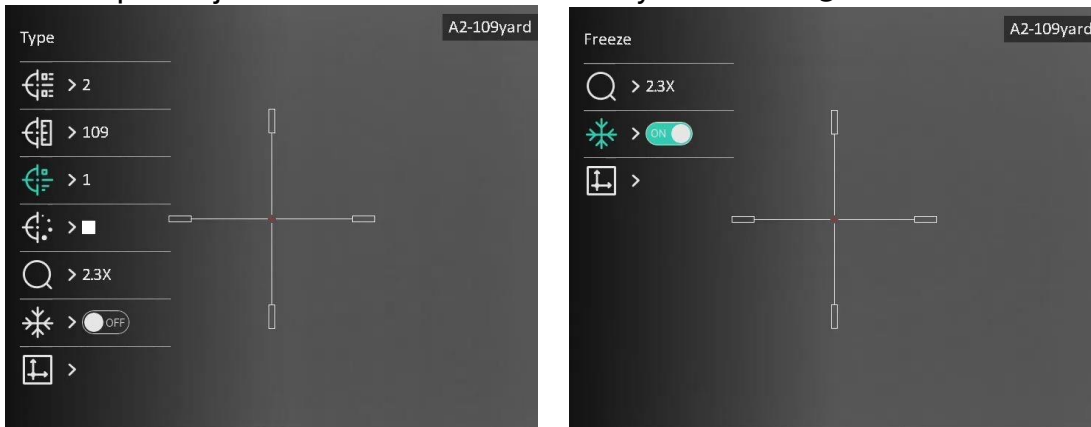

Figure 2-12 Zeroing

## Chapter 3 Image Settings

### 3.1 Adjust Diopter

#### Steps

1. Power on the device.
2. Open the lens cover.
3. Hold the device and make sure the eyepiece covers your eye.
4. Adjust the diopter adjustment ring until the OSD text or image is clear.

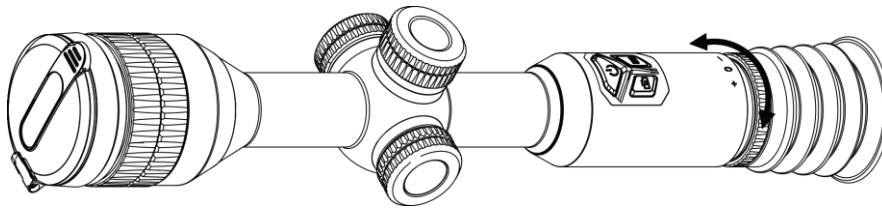

Figure 3-1 Adjust Diopter

---

#### Note

When adjusting diopter, DO NOT touch the surface of lens to avoid smearing the lens.

---

### 3.2 Adjust Focus

#### Steps

1. Power on the device and open the lens cover.
2. Hold the device and make sure the eyepiece covers your eye.
3. Adjust the focus ring until the image is clear.

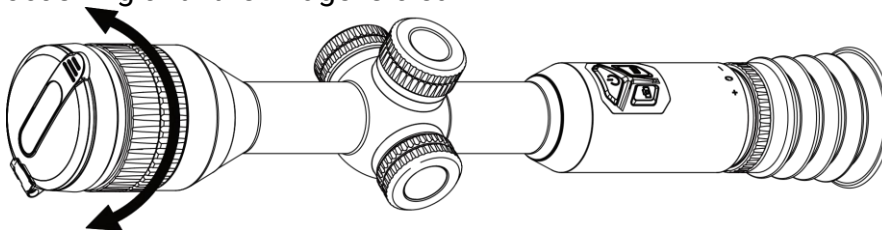

Figure 3-2 Adjust Focus



 **Note**

When focusing, do not touch the surface of lens to avoid smearing the lens.

---

### 3.3 Adjust Brightness

You can adjust the display brightness of the screen in the menu.

#### Steps

1. Hold the wheel to show the menu
2. Rotate the wheel to select  and press the wheel to confirm.
3. Rotate the wheel to adjust brightness.
4. Hold the wheel to save and exit.

### 3.4 Adjust Contrast

#### Steps

1. Hold the wheel to show the menu
2. Rotate the wheel to select  and press the wheel to confirm.
3. Rotate the wheel to adjust contrast.
4. Hold the wheel to save and exit.

### 3.5 Adjust Tone

#### Steps

1. Hold the wheel to show the menu
2. Rotate the wheel to select  and press the wheel to confirm.
3. Rotate the wheel to select a tone. **Warm** and **Cold** can be selected.
4. Hold the wheel to save and exit.



Figure 3-3 Adjust Tone

## 3.6 Adjust Sharpness

### Steps

1. Hold the wheel to show the menu
2. Rotate the wheel to select  and press the wheel to confirm.
3. Rotate the wheel to adjust sharpness.
4. Hold the wheel to save and exit.



Figure 3-4 Sharpness Comparison

## 3.7 Select Scene Mode

You can select proper scene mode according to actual using scene to improve the display effect.

### Steps

1. Hold the wheel to show the menu
2. Rotate the wheel to select  and press the wheel to confirm.
3. Rotate the wheel to switch scene modes.

- **Recognition:** Recognition mode is recommended in normal scene.
  - **Jungle:** Jungle mode is recommended in hunting environment.
4. Hold the wheel to save settings and exit.

## 3.8 Set Palettes

You can select different palettes to display the same scene in different effects. Press  in the live view interface to switch palettes.

### White Hot

The hot part is light-colored in view. The higher the temperature is, the lighter the color is.



### Black Hot

The hot part is black-colored in view. The higher the temperature is, the darker the color is.



### Red Hot

The hot part is red-colored in view. The higher the temperature is, the redder the color is.



### Fusion





From high temperature to low temperature, the image is colored in from white, yellow, red, pink to purple.



## 3.9 Flat Field Correction

This function can correct non-uniformity of display.

### Steps

1. Hold the wheel to show the menu.
2. Go to  **Function Settings**, and select  **Image Calib**.
3. Rotate the wheel to switch the image calibration modes, and press the wheel to confirm.
  - **Auto FFC**: The device calibrates image automatically according to the set schedule when switching on the camera.
  - **Manual FFC**: In the live view interface, hold  to trigger calibration.
  - **External**: Cover the lens cover, and then hold  to trigger calibration in the live view interface.
4. Hold the wheel to save the settings and exit.

**Note**



The countdown will start before the device performs FFC automatically.

---

## 3.9 Correct Defective Pixel

The device can correct the defective pixels on the screen.

### Steps

1. Hold the wheel to show the menu.
  2. Select  **Function Settings**, and press the wheel to enter the setting interface.
  3. Select , and press the wheel to enter the DPC setting interface.
  4. Press the wheel to select the **X** or **Y** axis. Rotate the wheel to set the coordinates until the cursor reaches the dead pixel. If you select **X**, the cursor moves left and right; if you select **Y**, the cursor moves up and down. Press the wheel again to finish the setting.
  5. Press the wheel twice to correct the dead pixel.
  6. Hold the wheel to save and exit.
- 

**Note**

- The selected defective pixel can be magnified and displayed on the bottom right of the interface.



**Figure 3-5 Correct Defective Pixel**

- If the screen OSD blocks the defective pixel, move the cursor to reach the defective pixel, then the device performs mirror display automatically.
- 

## 3.11 Adjust Digital Zoom

In the live view interface, rotate the wheel to switch the digital zoom ratio of the device.

---

You can set the zoom mode as below.

### Steps

1. In the menu, select  and press the wheel to confirm.
2. Rotate the wheel to select a zoom mode. **Continuous** and **Multiple** can be selected.
  - **Continuous**: In the live view interface, rotate the wheel to zoom in or zoom out by 0.1× continuously.
  - **Multiple**: In the live view interface, rotate the wheel to set the digital zoom ratio to 1×, 2×, 4×, or 8×.
3. Hold the wheel to save and exit.

---

### Note

When switching the digital zoom ratio, the top left interface displays the actual magnification (Actual Magnification = Lens Optical Magnification × Digital Zoom Ratio). For example, the lens optical magnification is 2.3× and the digital zoom ratio is 2×, the actual magnification is 4.6×.

---

## 3.12 Set Picture in Picture Mode

### Steps

1. Hold the wheel to show the menu.
2. Select , and press the wheel to enable it. The details are shown in the upper center of the interface.
3. Hold the wheel to exit.

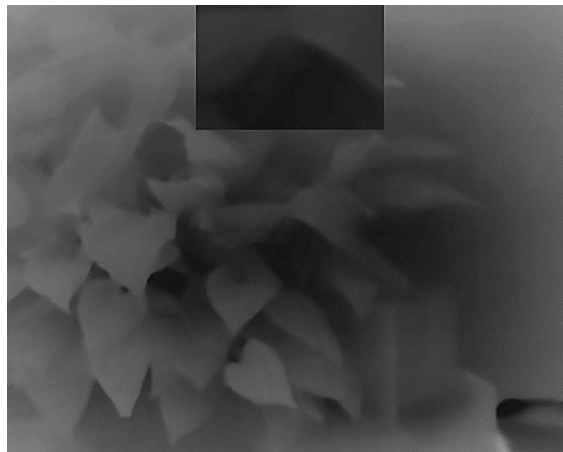

Figure 3-6 Set Picture in Picture Mode

---

### Note

- When reticle is enabled, the PIP view is the detail of reticle. When reticle is turned off,

the PIP view is the detail of central part.

- If the PIP function is enabled, only the PIP view zooms when adjusting the digital zoom ratio.
-

## Chapter 4 Zeroing

### 4.1 Select Zeroing Profile

If different users use the same device, the users can configure and save the reticle settings in their respective zeroing profiles.

#### Steps

1. In the menu, select  and press the wheel to confirm.
2. Rotate the wheel to select a zeroing profile.
3. Hold the wheel to save and exit.

#### Result

The right top of the image displays the reticle information. For example, A2-109yard means you are using the No. 2 reticle in zeroing profile A, and the set distance is 109 yards.

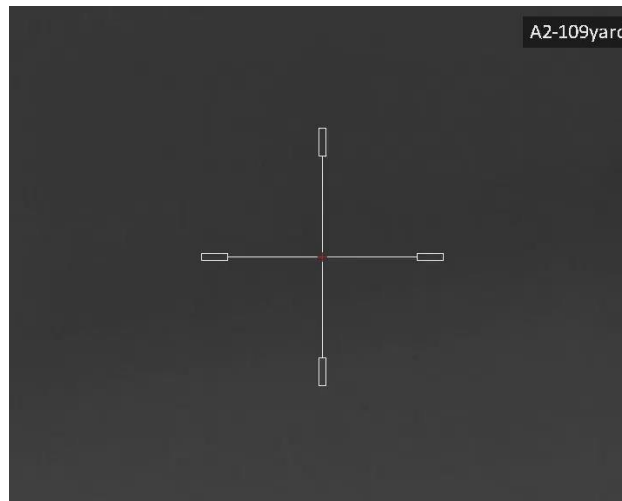

Figure 4-1 Using a Reticle

---

#### Note

There are 5 zeroing profiles in total, and you can configure 5 reticles in each zeroing profile.

---

### 4.2 Set Reticle

You can select a reticle in the current zeroing profile, and set parameters such as type,

---







color, and position for the reticle.

## Before You Start

Select a zeroing profile first.

## Steps

1. In the live view interface, hold the wheel to show the menu.
2. Select , and press the wheel to enter the setting interface.
3. Select  **Zeroing**, and press the wheel to confirm. Rotate the wheel to select a reticle No. You can select **OFF** to turn off the reticle.
4. Select  **Type**, and press the wheel to confirm. Rotate the wheel to select the reticle type. 10 types of reticles can be selected.
5. Select  **Color**, and press the wheel to confirm. Rotate the wheel to set the reticle color. **Black, White, Green, and Red** are selectable.

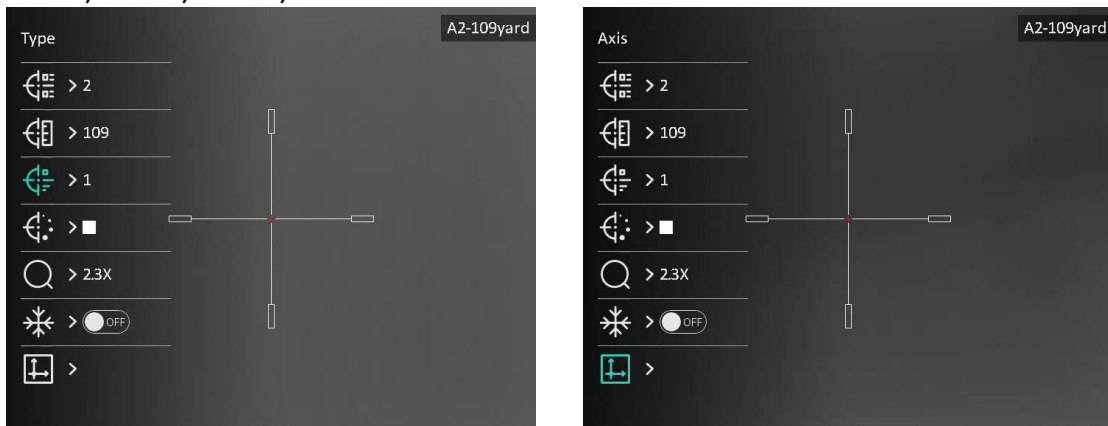

**Figure 4-2 Set Reticle**

6. (Optional) Repeat 3 to 5 to set other reticles in this zeroing profile.

---

### Note

When you switch the reticle No., a prompt will appear on the interface. Select **OK** to save the parameters for the current reticle.

---

7. Hold the wheel to exit according to the prompt.
    - **OK**: Save the parameter and exit.
    - **CANCEL**: Exit and not save the parameters.
- 

### Note

- There are 5 reticles can be configured in a zeroing profile.
- If the PIP function is enabled, the aimed target can be magnified on the interface.

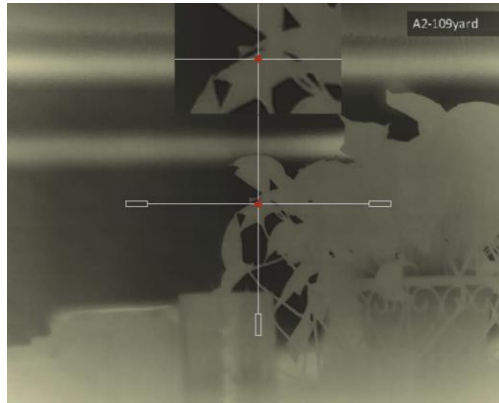

**Figure 4-3 PIP Effect in Reticle Mode**

- In black hot mode and white hot mode, if you set the reticle color as white or black, the color of the reticle will be inverted automatically to better aim at the target.

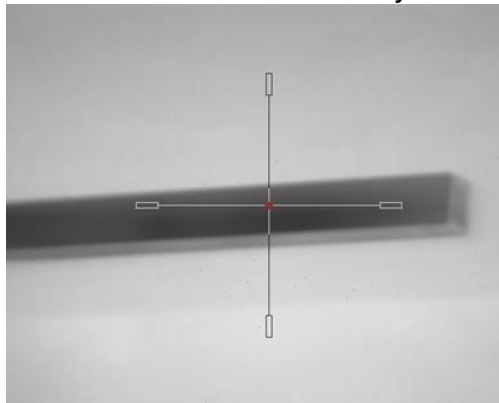

**Figure 4-4 Inverted Reticle Color**

---



## 4.3 Correct Reticle





Correcting the reticle can help you aim at the target with high accuracy by marking the offset between the big reticle and small reticle. Functions such as **Freeze** and **Zoom** help to adjust the reticle more accurately.

### Before You Start

Select a zeroing profile first.

### Steps

1. In the live view interface, hold the wheel to show the menu.
2. Select , and press the wheel to enter the zeroing setting interface.
3. Select  **Zeroing**, and press the wheel to confirm. Rotate the wheel to select a reticle you want to correct.

4. Set the distance to the target.
  - 1) Rotate the wheel to select  **Distance**.
  - 2) Press the wheel to select the number you want to change.
  - 3) Rotate the wheel to change the number, and press the wheel to finish the setting.
5. Select  **Zoom**, and press the wheel to confirm. Rotate the wheel to set the digital zoom ratio.
6. Aim at the target and pull the trigger. Align the reticle with the point of impact.
  - 1) Aim the big reticle at the target.
  - 2) Select  **Freeze**. Press the wheel to enable the function.
  - 3) Select  **Axis**. Rotate the wheel to set the coordinates until the big reticle aligns with the point of impact. If you select **X**, the reticle moves left and right; if you select **Y**, the reticle moves up and down. Press the wheel to finish setting.

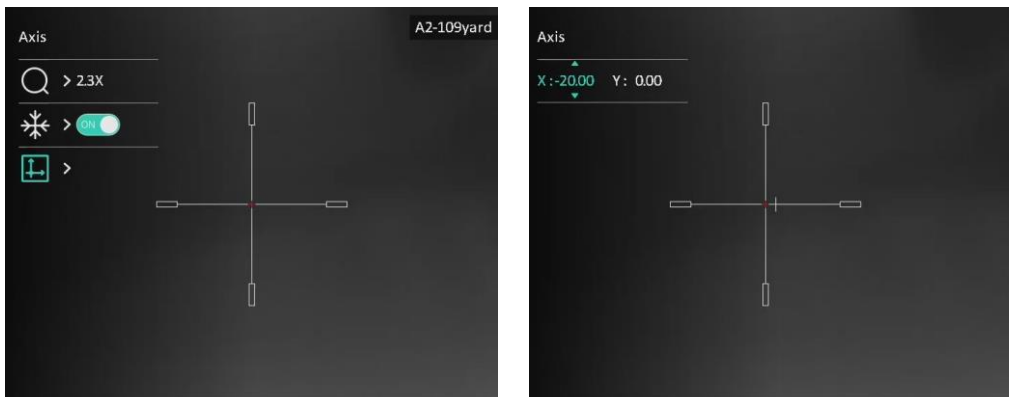

**Figure 4-5 Enable Freeze**

---

### **Note**

- When you switch the reticle No., a prompt will appear on the interface. Select **OK** to save the parameters for the current reticle.
- When enabling the freeze function in reticle, you can adjust the position of the cursor on a frozen image. This function can prevent image flutter.

- 
7. Hold the wheel to exit the setting interface according to the prompt.
    - **OK**: Save the parameter and exit.
    - **CANCEL**: Exit without saving the parameters.
  8. Pull the trigger again to verify that the aiming point aligns with the point of impact.
  9. (Optional) Repeat 3 to 8 to set the position for other reticles in this zeroing profile.

## Chapter 5 Measure Distance

The device can detect the distance between the target and the observation position.

### Before You Start

When measuring the distance, keep the hand and the position steady. Otherwise, the accuracy may be affected.

### Steps

1. Hold the wheel to show the menu.
  2. Rotate the wheel to select  and press the wheel to go to the setting interface.
  3. Set the parameters for the target.
    - 1) Rotate the wheel to select the target from **Deer, Grey Wolf, Brown Bear, and Custom.**
    - 2) Press and rotate the wheel to set target height.
- 

### Note

The available height ranges from 0.1 m to 9.0 m.

---

- 3) Press the wheel to confirm.
- 4) Hold the wheel to save the settings and return to the distance measurement interface.
4. Align the center of top mark with the edge of target top, and press the wheel to confirm.
5. Align the center of bottom mark with the edge of target bottom, and press the wheel to confirm.

### Result

The right top of the image displays the distance measurement result and the height of the target.

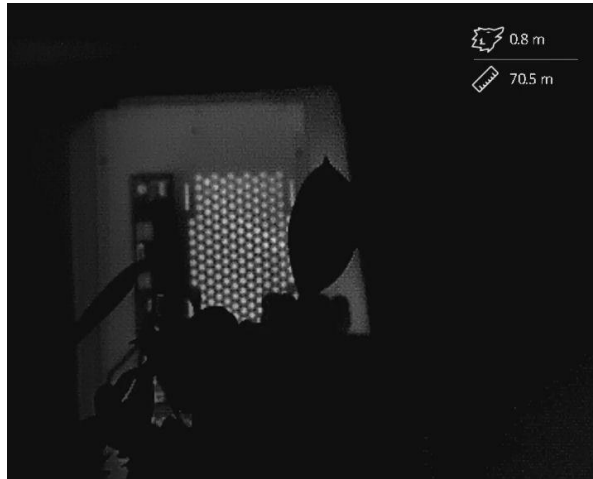



**Figure 5-1 Measurement Result**

## Chapter 6 General Settings

### 6.1 Set OSD

You can choose whether to display the OSD information on the live view interface.

#### Steps

1. Hold the wheel to show the menu.
2. Go to  **Function Settings**, and select .
3. Press the wheel to enter the setting interface. Rotate the wheel to select the OSD information you want to display or hide.
4. Press the wheel to enable or disable the selected OSD information.
5. Hold the wheel to save and exit.

---

#### Note



Only when the OSD function is enabled, other OSD information can be displayed.

---

### 6.2 Set Brand Logo

You can add brand logo on the live view interface, captures, and videos.

#### Steps

1. Hold the wheel to show the menu.
2. Go to  **Function Settings**, and select .
3. Press the wheel to enable **Brand Logo**.
4. Hold the wheel to save the settings and exit.

#### Result

The brand logo is displayed at the bottom left of the image.

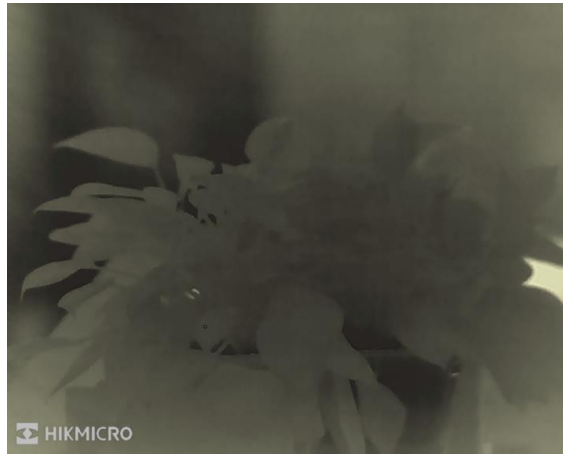



Figure 6-1 Brand Logo Display

## 6.3 Burning Prevention

Avoid direct sunlight and enable the burning prevention function to reduce the risk of sensor damage from the heat.

### Steps

1. Hold the wheel to show the menu.
2. Go to  **Function Settings**, and select .
3. Press the wheel to enable or disable the **Burn-Prevention** function.
4. Hold the wheel to save the settings and exit.

## 6.4 Capture and Video

### 6.4.1 Capture Picture

In the live view interface, press  to capture picture.

---

#### Note

When capturing succeeds, the image freezes for 1 second and a prompt shows on the display.

For exporting captured pictures, refer to **Export Files**.

---

### 6.4.2 Set Audio

If you enable the audio function, the sound will be recorded with the video. When there is

too loud noise in the video, you can turn off this function.

### Steps

1. Hold the wheel to show the menu.
2. Rotate the wheel to select , and press the wheel to enable or disable this function.
3. Hold the wheel to save and exit.

## 6.4.3 Record Video

### Steps

1. In the live view interface, hold  and start recording. The recording time is displayed on the left top of image.



**Figure 6-2 Start Recording**

2. Hold  again to stop recording.

### What to do next

For exporting recording files, refer to **Export Files**.

## 6.4.4 Prerecord Video

After enabling this function, the device can automatically record the 7 seconds before and after the recoil-activation.

### Steps

1. Hold the wheel to show the menu.
2. Rotate the wheel to select .
3. Press the wheel to switch on/off this function.
4. Hold the wheel to save and exit.



 **Note**

If the device recoils continuously, the device will record the 7 seconds before the first recoil until the 7 seconds after the last recoil.

---

**What to do next**

For exporting recording files, refer to **Export Files**.



## 6.5 Hot Tracking

The device can detect the highest temperature spot in the scene and mark it on display.

**Steps**

1. Hold the wheel to show the menu.
2. Rotate the wheel to select , and press the wheel to mark the spot of highest temperature.
3. Hold the wheel to save settings and exit.

**Result**

When the function is enabled,  displays in the spot of highest temperature. When the scene changes, the  moves.



**Figure 6-3 Hot Tracking**

## 6.6 Export Files

### 6.6.1 Export Files via HIKMICRO Sight

You can access device albums and export files to your phone via HIKMICRO Sight.

## Before You Start

Install HIKMICRO Sight on your mobile phone.

### Steps

1. Open HIKMICRO Sight and connect your device to the app. See **App Connection**.
2. Tap **Media** to access device albums.

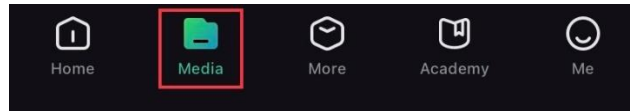

**Figure 6-4 Access Device Albums**

3. Tap **Local** or **Device** to view the photos and videos.
  - **Local**: You can view the previous files on the app.
  - **Device**: You can view the files of the current device.

---

### Note

The photos or videos may not show in **Device**. Please pull down to refresh the page.

---

4. Tap to select a file, and tap **Download** to export the file to your local phone albums.



**Figure 6-5 Export Files**

---

### Note

- Go to **Me** → **About** → **User Manual** on the app to see more detailed operations.
  - You can also access device albums by tapping bottom left icon in the live view interface.
  - The exporting operation may vary due to app updates. Please take the actual app version for reference.
- 

## 6.6.2 Export Files via PC

This function is used to export recorded videos and captured pictures.

### Before You Start

- Make sure the device is turned on when connecting the cable.
- Remove the battery from the device before connecting to your PC, or it may cause

device damage.

### Steps

1. Connect the device and PC with a Type-C cable.
  2. Open computer disk and select the disk of device. Go to the **DCIM** folder and find the folder named after the capture year and month. For example, if you capture a picture or record a video in June 2022, go to **DCIM** → **202206** to find the picture or video.
  3. Select and copy the files to PC.
  4. Disconnect the device from your PC.
- 



### Note

- The device displays images when you connect it to PC, but functions such as recording, capturing and hotspot are disabled.
  - When you connect the device to PC for the first time, it installs the drive program automatically.
-

## Chapter 7 System Settings



### 7.1 Adjust Date

#### Steps

1. Hold the wheel to show the menu.
2. Go to  **General Settings**, and select .
3. Press the wheel to enter the configuration interface.
4. Press the wheel to select the year, month, or day, and rotate the wheel to change the number.
5. Hold the wheel to save settings and exit.

### 7.2 Synchronize Time



#### Steps

1. Hold the wheel to show the menu.
2. Go to  **General Settings**, and select .
3. Press the wheel to enter the configuration interface.
4. Rotate the wheel to switch the clock system. 24-hour and 12-hour clock are selectable.  
If you select 12-hour clock, press and rotate the wheel to select AM or PM.
5. Press the wheel to select hour or minute, and rotate the wheel to change the number.
6. Hold the wheel to save settings and exit.

### 7.3 Language Settings

You can select the device language in this function.



#### Steps

1. Hold the wheel to show the menu.
2. Go to  **General Settings**, and select .
3. Press the wheel to enter the language configuration interface.
4. Rotate the wheel to select the language as required, and press the wheel to confirm.
5. Hold the wheel to save settings and exit.

## 7.4 Unit Settings



You can switch the unit for distance measurement.

### Steps

1. Hold the wheel to show the menu.
2. Go to  **General Settings**, and select .
3. Press the wheel to enter the unit setting interface.
4. Rotate the wheel to select the unit as required. Yard and m (meter) are selectable.
5. Hold the wheel to save settings and exit.



## 7.5 View Device Information

### Steps

1. Hold the wheel to show the menu.
2. Go to  **General Settings**, and select .
3. Press the wheel to confirm. You can view the device information such as version and serial No.
4. Hold the wheel to save settings and exit.

## 7.6 Restore Device

### Steps

1. Hold the wheel to show the menu of device.
2. Go to  **General Settings**, and select .
3. Press the wheel to restore the device to defaults according to the prompt.

## Chapter 8 Frequently Asked Questions

### 8.1 Why is the monitor off?

Check whether the device is off-battery. Check the monitor after charging the device for 5 minutes.

### 8.2 The image is not clear, how to adjust it?

Adjust the diopter adjustment ring or focus ring until the image is clear. Refer to ***Adjust Diopter*** or ***Adjust Focus***.

### 8.3 Capturing or recording fails. What's the problem?

Check the following items.

- Whether the device is connected to your PC. Capturing or recording is disabled in this status.
- Whether the storage space is full.
- Whether the device is low-battery.

### 8.4 Why the PC cannot identify the device?

Check the following items.

- Whether the device is connected to your PC with supplied USB cable.
- If you use other USB cables, make sure the cable length is no longer than 1 m.

## Safety Instruction



These instructions are intended to ensure that user can use the product correctly to avoid danger or property loss. Please read all the safety information carefully before using.

### Laws and Regulations

Use of the product must be in strict compliance with the local electrical safety regulations.

### Symbol Conventions

The symbols that may be found in this document are defined as follows.

Symbol	Description
 <b>Danger</b>	Indicates a hazardous situation which, if not avoided, will or could result in death or serious injury.
 <b>Caution</b>	Indicates a potentially hazardous situation which, if not avoided, could result in equipment damage, data loss, performance degradation, or unexpected results.
 <b>Note</b>	Provides additional information to emphasize or supplement important points of the main text.

### Transportation

- Keep the device in original or similar packaging while transporting it.
- Keep all wrappers after unpacking them for future use. In case of any failure occurred, you need to return the device to the factory with the original wrapper. Transportation without the original wrapper may result in damage on the device and the company shall not take any responsibilities.
- DO NOT drop the product or subject it to physical shock. Keep the device away from magnetic interference.

### Power Supply

- Please purchase the charger by yourself. Input voltage should meet the Limited Power Source (5 VDC, 2A) according to the IEC61010-1 or IEC 62368-1 standard. Please refer to technical specifications for detailed information.
- Make sure the plug is properly connected to the power socket.
- DO NOT connect multiple devices to one power adapter, to avoid over-heating or fire hazards caused by overload.
- The power source should meet limited power source or PS2 requirements according to IEC 62368-1 standard.

### Battery

- The built-in battery type is 18650 with the protection board, and the battery size should

be 23 mm × 67 mm. The rated voltage and capacity are 3.6 VDC/3350 mAh.

- The external removable battery type is CR123A, and the max. rated voltage and capacity are 3 VDC and 1600 mAh.
- For long-term storage of the battery, make sure it is fully charged every half year to ensure the battery quality. Otherwise, damage may occur.
- CAUTION: Risk of explosion if the battery is replaced by an incorrect type.
- The built-in battery cannot be dismantled. Please contact the manufacture for repair if necessary.
- Make sure the battery temperature is between 0°C to 45°C (32°F to 113°F) when charging.
- Improper replacement of the battery with an incorrect type may defeat a safeguard (for example, in the case of some lithium battery types).
- Do not dispose of the battery into fire or a hot oven, or mechanically crush or cut the battery, which may result in an explosion.
- Do not leave the battery in an extremely high temperature surrounding environment, which may result in an explosion or the leakage of flammable liquid or gas.
- Do not subject the battery to extremely low air pressure, which may result in an explosion or the leakage of flammable liquid or gas.
- Dispose of used batteries according to the instructions.
- Confirm there is no flammable material within 2 m of the charger during charging.
- DO NOT place the battery in the reach of children.
- DO NOT swallow the battery to avoid chemical burns.

### **Maintenance**

- If the product does not work properly, please contact your dealer or the nearest service center. We shall not assume any responsibility for problems caused by unauthorized repair or maintenance.
- Wipe the device gently with a clean cloth and a small quantity of ethanol, if necessary.
- If the equipment is used in a manner not specified by the manufacturer, the protection provided by the device may be impaired.
- Clean the lens with soft and dry cloth or wiping paper to avoid scratching it.

### **Using Environment**

- Make sure the running environment meets the requirement of the device. The operating temperature shall be between -30 °C to 55 °C (-22 °F to 131 °F), and humidity shall be 5% to 95%.
- DO NOT expose the device to high electromagnetic radiation or dusty environments.
- DO NOT aim the lens at the sun or any other bright light.
- Place the device in a dry and well-ventilated environment.
- When any laser equipment is in use, make sure that the device lens is not exposed to the laser beam, or it may burn out.



- Avoid equipment installation on vibratory surface or places subject to shock (neglect may cause equipment damage).

### **Emergency**

If smoke, odor, or noise arises from the device, immediately turn off the power, unplug the power cable, and contact the service center.

### **Manufacture Address**

Room 313, Unit B, Building 2, 399 Danfeng Road, Xixing Subdistrict, Binjiang District,  
Hangzhou, Zhejiang 310052, China  
Hangzhou Microimage Software Co., Ltd.

COMPLIANCE NOTICE: The thermal series products might be subject to export controls in various countries or regions, including without limitation, the United States, European Union, United Kingdom and/or other member countries of the Wassenaar Arrangement. Please consult your professional legal or compliance expert or local government authorities for any necessary export license requirements if you intend to transfer, export, re-export the thermal series products between different countries.

## Legal Information

©Hangzhou Microimage Software Co., Ltd. All rights reserved.

### **About this Manual**

The Manual includes instructions for using and managing the Product. Pictures, charts, images and all other information hereinafter are for description and explanation only. The information contained in the Manual is subject to change, without notice, due to firmware updates or other reasons. Please find the latest version of this Manual at the HIKMICRO website ([www.hikmicrotech.com](http://www.hikmicrotech.com)).

Please use this Manual with the guidance and assistance of professionals trained in supporting the Product.

### **Trademarks Acknowledgement**

 **HIKMICRO** and other HIKMICRO's trademarks and logos are the properties of HIKMICRO in various jurisdictions.

Other trademarks and logos mentioned are the properties of their respective owners.

### **LEGAL DISCLAIMER**

TO THE MAXIMUM EXTENT PERMITTED BY APPLICABLE LAW, THIS MANUAL AND THE PRODUCT DESCRIBED, WITH ITS HARDWARE, SOFTWARE AND FIRMWARE, ARE PROVIDED "AS IS" AND "WITH ALL FAULTS AND ERRORS". HIKMICRO MAKES NO WARRANTIES, EXPRESS OR IMPLIED, INCLUDING WITHOUT LIMITATION, MERCHANTABILITY, SATISFACTORY QUALITY, OR FITNESS FOR A PARTICULAR PURPOSE. THE USE OF THE PRODUCT BY YOU IS AT YOUR OWN RISK. IN NO EVENT WILL HIKMICRO BE LIABLE TO YOU FOR ANY SPECIAL, CONSEQUENTIAL, INCIDENTAL, OR INDIRECT DAMAGES, INCLUDING, AMONG OTHERS, DAMAGES FOR LOSS OF BUSINESS PROFITS, BUSINESS INTERRUPTION, OR LOSS OF DATA, CORRUPTION OF SYSTEMS, OR LOSS OF DOCUMENTATION, WHETHER BASED ON BREACH OF CONTRACT, TORT (INCLUDING NEGLIGENCE), PRODUCT LIABILITY, OR OTHERWISE, IN CONNECTION WITH THE USE OF THE PRODUCT, EVEN IF HIKMICRO HAS BEEN ADVISED OF THE POSSIBILITY OF SUCH DAMAGES OR LOSS.

YOU ACKNOWLEDGE THAT THE NATURE OF THE INTERNET PROVIDES FOR INHERENT SECURITY RISKS, AND HIKMICRO SHALL NOT TAKE ANY RESPONSIBILITIES FOR ABNORMAL OPERATION, PRIVACY LEAKAGE OR OTHER DAMAGES RESULTING FROM CYBER-ATTACK, HACKER ATTACK, VIRUS INFECTION, OR OTHER INTERNET SECURITY RISKS; HOWEVER, HIKMICRO WILL PROVIDE TIMELY TECHNICAL SUPPORT IF REQUIRED. YOU AGREE TO USE THIS PRODUCT IN COMPLIANCE WITH ALL APPLICABLE LAWS, AND YOU ARE SOLELY RESPONSIBLE FOR ENSURING THAT YOUR USE CONFORMS TO THE APPLICABLE LAW. ESPECIALLY, YOU ARE RESPONSIBLE, FOR USING THIS PRODUCT IN A MANNER THAT DOES NOT INFRINGE ON THE RIGHTS OF THIRD PARTIES, INCLUDING WITHOUT LIMITATION, RIGHTS OF PUBLICITY, INTELLECTUAL PROPERTY RIGHTS, OR DATA PROTECTION AND OTHER PRIVACY RIGHTS. YOU SHALL NOT USE THIS PRODUCT

FOR ILLEGAL HUNTING ANIMALS, INVASION OF PRIVACY OR ANY OTHER PURPOSE WHICH IS ILLEGAL OR DETRIMENTAL TO THE PUBLIC INTEREST. YOU SHALL NOT USE THIS PRODUCT FOR ANY PROHIBITED END-USES, INCLUDING THE DEVELOPMENT OR PRODUCTION OF WEAPONS OF MASS DESTRUCTION, THE DEVELOPMENT OR PRODUCTION OF CHEMICAL OR BIOLOGICAL WEAPONS, ANY ACTIVITIES IN THE CONTEXT RELATED TO ANY NUCLEAR EXPLOSIVE OR UNSAFE NUCLEAR FUEL-CYCLE, OR IN SUPPORT OF HUMAN RIGHTS ABUSES.

PLEASE FOLLOW ALL THE PROHIBITIONS AND EXCEPTIONAL CAVEATS OF ALL APPLICABLE LAWS AND REGULATIONS, IN PARTICULAR, THE LOCAL FIREARMS AND/OR HUNTING LAWS AND REGULATIONS. PLEASE ALWAYS CHECK NATIONAL PROVISIONS AND REGULATIONS BEFORE PURCHASE OR USE OF THIS PRODUCT. PLEASE NOTE THAT YOU MAY HAVE TO APPLY FOR PERMITS, CERTIFICATES, AND/OR LICENSES BEFORE ANY PURCHASING, SELLING, MARKETING AND/OR USING OF THE PRODUCT. HIKMICRO SHALL NOT BE LIABLE FOR ANY SUCH ILLEGAL OR IMPROPER PURCHASING, SELLING, MARKETING, AND END USES AND ANY SPECIAL, CONSEQUENTIAL, INCIDENTAL, OR INDIRECT DAMAGES ARISING THEREOF.

IN THE EVENT OF ANY CONFLICTS BETWEEN THIS MANUAL AND THE APPLICABLE LAW, THE LATTER PREVAILS.

## Regulatory Information

---

**These clauses apply only to the products bearing the corresponding mark or information.**

---

### FCC Information

Note: This product has been tested and found to comply with the limits for a Class B digital device, pursuant to Part 15 of the FCC Rules. These limits are designed to provide reasonable protection against harmful interference in a residential installation. This product generates, uses, and can radiate radio frequency energy and, if not installed and used in accordance with the instructions, may cause harmful interference to radio communications. However, there is no guarantee that interference will not occur in a particular installation. If this product does cause harmful interference to radio or television reception, which can be determined by turning the equipment off and on, the user is encouraged to try to correct the interference by one or more of the following measures:

- Reorient or relocate the receiving antenna.
- Increase the separation between the equipment and receiver.
- Connect the equipment into an outlet on a circuit different from that to which the receiver is connected.
- Consult the dealer or an experienced radio/TV technician for help.

Please take attention that changes or modification not expressly approved by the party responsible for compliance could void the user's authority to operate the equipment.

This device complies with Part 15 of the FCC Rules. Operation is subject to the following two conditions:

- (1) This device may not cause harmful interference, and
- (2) This device must accept any interference received, including interference that may cause undesired operation.

This equipment complies with FCC radiation exposure limits set forth for an uncontrolled environment.

### EU Compliance Statement



This product and - if applicable - the supplied accessories too are marked with "CE" and comply therefore with the applicable harmonized European standards listed under the Directive 2014/30/EU (EMCD), Directive 2014/35/EU (LVD), Directive 2011/65/EU (RoHS), Directive 2014/53/EU.

Hereby, Hangzhou Microimage Software Co., Ltd. declares that this device (refer to the label) is in compliance with Directive 2014/53/EU. The full text of the EU declaration of conformity is available at the

following internet address:

<https://www.hikmicrotech.com/en/support/download-center/declaration-of-conformity/>

### **Frequency Bands and Power (for CE)**

The frequency bands and transmitting power (radiated and/or conducted) nominal limits applicable to the following radio equipment are as follows:

Wi-Fi 2.4 GHz (2.4 GHz to 2.4835 GHz), 20 dBm

For the device without a supplied power adapter, use the power adapter provided by a qualified manufacturer. Refer to the product specification for detailed power requirements.

For the device without a supplied battery, use the battery provided by a qualified manufacturer. Refer to the product specification for detailed battery requirements.



Directive 2012/19/EU (WEEE Directive): Products marked with this symbol cannot be disposed of as unsorted municipal waste in the European Union. For proper recycling, return this product to your local supplier upon the purchase of equivalent new equipment, or dispose of it at designated collection points. For more information see: [www.recyclethis.info](http://www.recyclethis.info).



Directive 2006/66/EC and its amendment 2013/56/EU (Battery Directive): This product contains a battery that cannot be disposed of as unsorted municipal waste in the European Union. See the product documentation for specific battery information. The battery is marked with this symbol, which may include lettering to indicate cadmium (Cd), lead (Pb), or mercury (Hg). For proper recycling, return the battery to your supplier or to a designated collection point. For more information see: [www.recyclethis.info](http://www.recyclethis.info).

### **Industry Canada ICES-003 Compliance**

This device meets the CAN ICES-003 (B)/NMB-003(B) standards requirements.

This device complies with Industry Canada license-exempt RSS standard(s). Operation is subject to the following two conditions:

- (1) this device may not cause interference, and
- (2) this device must accept any interference, including interference that may cause undesired operation of the device.

This equipment complies with IC RSS-102 radiation exposure limits set forth for an uncontrolled environment.

## **Conformité Industrie Canada ICES-003**

Cet appareil répond aux exigences des normes CAN ICES-003 (B)/NMB-003 (B).

Cet appareil est conforme aux normes RSS exemptes de licence d'Industrie Canada. Son fonctionnement est soumis aux deux conditions suivantes :

- (1) cet appareil ne doit pas causer d'interférences, et
- (2) cet appareil doit accepter toute interférence reçue, notamment les interférences susceptibles d'occasionner un fonctionnement indésirable de l'appareil.

Cet appareil est conforme aux limites d'exposition au rayonnement IC RSS-102 établies pour un environnement non contrôlé.

## **INFORMATIONEN FÜR PRIVATE HAUSHALTE**

### **1. Getrennte Erfassung von Altgeräten:**

Elektro- und Elektronikgeräte, die zu Abfall geworden sind, werden als Altgeräte bezeichnet. Besitzer von Altgeräten haben diese einer vom unsortierten Siedlungsabfall getrennten Erfassung zuzuführen. Altgeräte gehören insbesondere nicht in den Hausmüll, sondern in spezielle Sammel- und Rückgabesysteme.

### **2. Batterien und Akkus sowie Lampen:**

Besitzer von Altgeräten haben Altbatterien und Altakkumulatoren, die nicht vom Altgerät umschlossen sind, die zerstörungsfrei aus dem Altgerät entnommen werden können, im Regelfall vor der Abgabe an einer Erfassungsstelle vom Altgerät zu trennen. Dies gilt nicht, soweit Altgeräte einer Vorbereitung zur Wiederverwendung unter Beteiligung eines öffentlich-rechtlichen Entsorgungsträgers zugeführt werden.

### **3. Möglichkeiten der Rückgabe von Altgeräten:**

Besitzer von Altgeräten aus privaten Haushalten können diese bei den Sammelstellen der öffentlich-rechtlichen Entsorgungsträger oder bei den von Herstellern oder Vertreibern im Sinne des ElektroG eingerichteten Rücknahmestellen unentgeltlich abgeben.

Rücknahmepflichtig sind Geschäfte mit einer Verkaufsfläche von mindestens 400 m<sup>2</sup> für Elektro- und Elektronikgeräte sowie diejenigen Lebensmittelgeschäfte mit einer Gesamtverkaufsfläche von mindestens 800 m<sup>2</sup>, die mehrmals pro Jahr oder dauerhaft Elektro- und Elektronikgeräte anbieten und auf dem Markt bereitstellen. Dies gilt auch bei Vertrieb unter Verwendung von Fernkommunikationsmitteln, wenn die Lager- und Versandflächen für Elektro- und Elektronikgeräte mindestens 400 m<sup>2</sup> betragen oder die gesamten Lager- und Versandflächen mindestens 800 m<sup>2</sup> betragen. Vertreter haben die Rücknahme grundsätzlich durch geeignete Rückgabemöglichkeiten in zumutbarer Entfernung zum jeweiligen Endnutzer zu gewährleisten. Die Möglichkeit der unentgeltlichen Rückgabe eines Altgerätes besteht bei rücknahmepflichtigen Vertreibern unter anderem dann, wenn ein neues gleichartiges Gerät, das im Wesentlichen die gleichen Funktionen erfüllt, an einen Endnutzer abgegeben wird.

### **4. Datenschutz-Hinweis:**

Altgeräte enthalten häufig sensible personenbezogene Daten. Dies gilt insbesondere für Geräte der Informations- und Telekommunikationstechnik wie Computer und

Smartphones. Bitte beachten Sie in Ihrem eigenen Interesse, dass für die Löschung der Daten auf den zu entsorgenden Altgeräten jeder Endnutzer selbst verantwortlich ist.

### **5. Bedeutung des Symbols „durchgestrichene Mülltonne“:**



Das auf Elektro- und Elektronikgeräten regelmäßig abgebildete Symbol einer durchgestrichenen Mülltonne weist darauf hin, dass das jeweilige Gerät am Ende seiner Lebensdauer getrennt vom unsortierten Siedlungsabfall zu erfassen ist.



**HIKMICRO**

See the World in a New Way

 Hikmicro Hunting.Global

 Hikmicro Hunting.Global

 HIKMICRO Outdoor

 HIKMICRO

 [www.hikmicrotech.com](http://www.hikmicrotech.com)

 [support@hikmicrotech.com](mailto:support@hikmicrotech.com)

**UD36350B**