



Thermal Binocular RAPTOR Series

User Manual V5.5.76 202312



Contact Us

CONTENTS

Chapter 1 Overview	1
1.1 Brief Description	1
1.2 Main Function	1
1.3 Appearance	1
Chapter 2 Preparation	4
2.1 Install Battery	4
2.2 Cable Connection	5
2.3 Mount Neck Strap	7
2.4 Power On/Off	7
2.5 Auto Screen Off	8
2.6 Menu Description	9
2.7 App Connection	9
2.8 Firmware Status	10
2.8.1 Check Firmware Status	10
2.8.2 Upgrade Device	10
Chapter 3 Image Settings	12
3.1 Adjust Device	12
3.2 Adjust Brightness	13
3.3 Adjust Contrast	13
3.4 Adjust Tone	13
3.5 Adjust Sharpness	14
3.6 Select Scene	14
3.7 Set Palettes	14
3.8 Set Fusion Level	17
3.9 Set Display Mode	17
3.10 Adjust Digital Zoom	17
3.11 Set Picture in Picture	18

Thermal Binocular User Manual

3.12 Flat Field Correction.....	18
3.13 Correct Defective Pixel	19
3.14 Set Infrared Light.....	19
3.15 Image Pro.....	20
3.16 Zoom Pro	20
Chapter 4 Measure Distance	21
Chapter 5 General Settings.....	22
5.1 Set OSD	22
5.2 Set Brand Logo	22
5.3 Burning Prevention.....	22
5.4 Capture and Video	23
5.4.1 Capture Picture	23
5.4.2 Set Audio	23
5.4.3 Record Video.....	23
5.4.4 View Local Files	24
5.5 Export Files	25
5.5.1 Export Files via HIKMICRO Sight.....	25
5.5.2 Export Files via PC.....	26
5.6 CVBS Video Output.....	27
5.7 Hot Tracking	27
5.8 Direction Display.....	28
5.8.1 Switch on Compass.....	28
5.8.2 Compass Calibration.....	29
5.8.3 Magnetic Declination Correction.....	29
5.9 Geographic Location Display.....	30
5.9.1 Device Location Display	30
5.9.2 Target Location Display	31
Chapter 6 System Settings	33
6.1 Adjust Date.....	33

Thermal Binocular User Manual

6.2 Synchronize Time	33
6.3 Set Language	33
6.4 Set Unit	34
6.5 View Device Information	34
6.6 Restore Device	34
Chapter 7 Frequently Asked Questions	35
7.1 Why does the charge indicator flash improperly?	35
7.2 Why is the power indicator off?	35
7.3 The image is not clear, how to adjust it?	35
7.4 Capturing or recording fails. What's the problem?	35
7.5 Why the PC cannot identify the device?	35
Safety Instruction	36
Legal Information	39
Regulatory Information	41

Chapter 1 Overview

1.1 Brief Description

HIKMICRO RAPTOR series is a powerful and innovative handheld thermal and digital night vision binocular which adopts a 12 μm infrared thermal sensor with NETD < 20mK sensitivity, 2560 \times 1440 low illumination CMOS sensor with built-in adjustable IR illuminator, and a precise built-in laser rangefinder up to 1000 m measuring distance. It offers excellent image quality in true living color or thermal during day and night observation in adverse weather conditions with up to 2600 m detection range. The binocular is mainly applied for day & night observation, hunting, hiking, searching and rescuing.

1.2 Main Function

- **Zoom Pro:** With Zoom Pro, the details of zoomed live view image will be enhanced.
- **Smart IR:** The smart IR function helps to view targets clearly in dark environment.
- **Distance Measurement:** With laser ranging, the device can detect the distance between the target and observation position.
- **Auto Screen Off:** This function darkens the screen to save energy and extend battery life.
- **App Connection:** The device can capture snapshots, record videos, and set parameters by HIKMICRO Sight App after being connected to your phone via hotspot.

1.3 Appearance

The appearance description of the thermal binocular is shown below. Please take the actual product for reference.

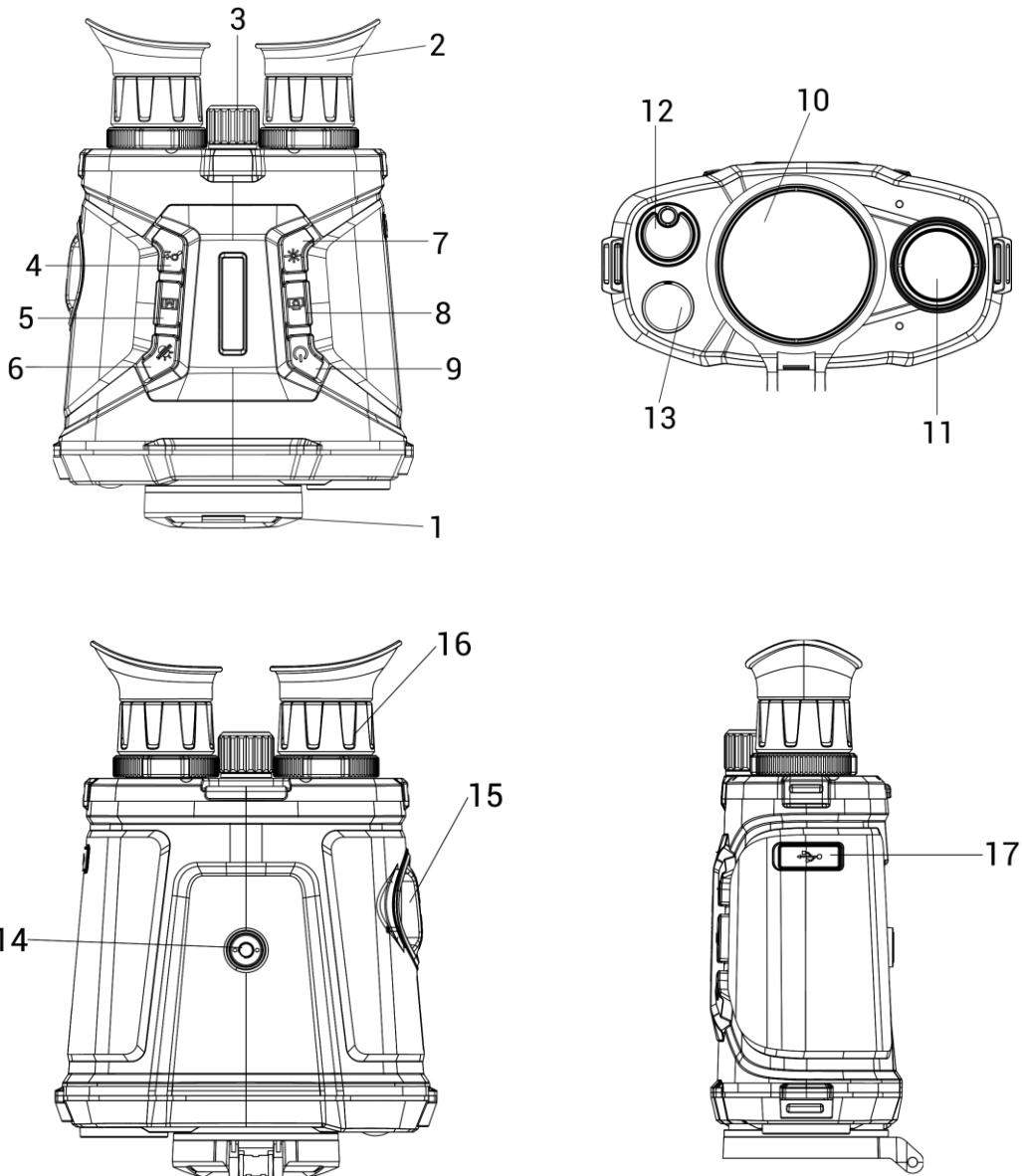

Figure 1-1 Device Appearance

Table 1-1 Buttons and Components

No.	Description	Function
1	Lens Cover	Protects the lens.
2	Eyepiece	The piece placed closest to the eye to view the target. Adjust the interpupillary distance by moving the eyepieces farther or closer to each other.
3	Focus Ring	Adjusts focus to obtain clear targets.

Thermal Binocular User Manual

No.	Description	Function
4	Zoom Key	Non-Menu Mode: <ul style="list-style-type: none"> ● Press: Switch digital zoom. ● Hold: Turn on/off PIP (Picture-in-Picture). Menu Mode: Press to move down.
5	Menu Key	Non-Menu Mode: <ul style="list-style-type: none"> ● Press: Switch palettes. ● Hold: Enter menu. Menu Mode: <ul style="list-style-type: none"> ● Press: Confirm/Set parameters. ● Hold: Save and exit menu.
6	Mode Key	Non-Menu Mode: <ul style="list-style-type: none"> ● Press to switch day/night/defog/auto mode. ● Hold: Correct non-uniformity of display (FFC). Menu Mode: Press to move up.
7	Measure Key	<ul style="list-style-type: none"> ● Press: Measure distance with laser for once. ● Hold: Measure distance continuously with laser.
8	Capture Key	<ul style="list-style-type: none"> ● Press: Capture snapshots. ● Hold: Start/Stop recording videos.
9	Power Key	Hold: Power on/off.
10	Thermal Lens	For thermal imaging.
11	Digital Camera Lens	For digital imaging.
12	Laser Ranger Finder	Measures the distance to the target with laser.
13	Infrared Light	Helps to view target clearly in dark environment.
14	Tripod Mount	Mounts the tripod.
15	Battery Compartment	For holding the batteries.
16	Diopter Adjustment Ring	Adjust the dioptic.
17	Type-C Interface	To connect the device to power supply or transmit data with a type-C cable.

Chapter 2 Preparation

2.1 Install Battery

Insert the batteries into the battery compartment.

Steps

1. Rotate the battery compartment cover counterclockwise to loosen it.

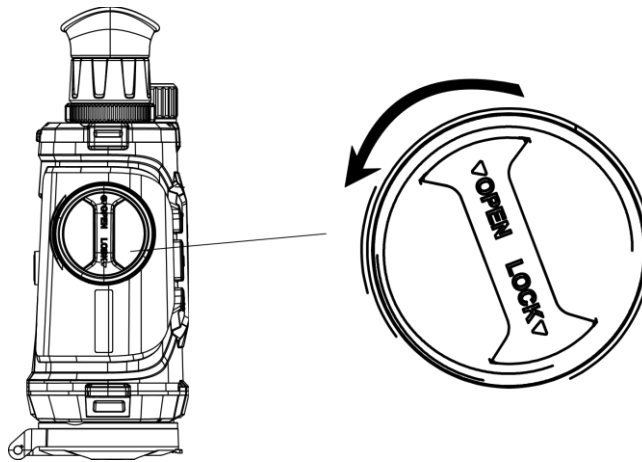

Figure 2-1 Loosen Knob

2. Take out the detachable battery compartment, and install the batteries as the positive and negative marks indicate.

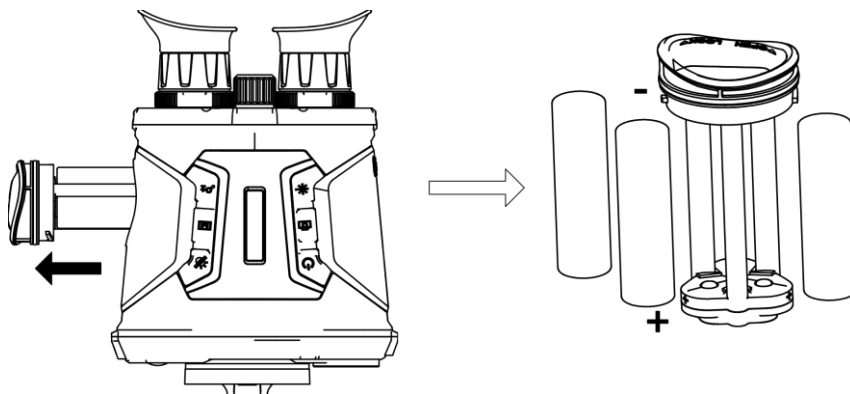

Figure 2-2 Install Batteries

3. Install the battery compartment back, and rotate the battery compartment cover clockwise to lock it.

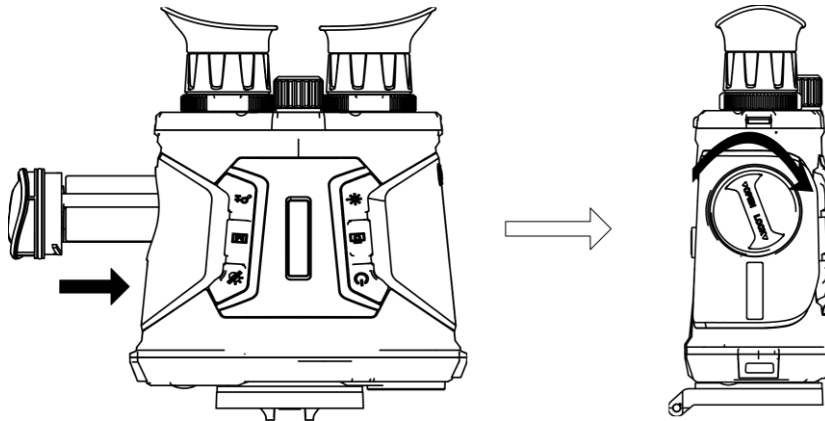

Figure 2-3 Install Battery Compartment

 **Note**

- Take the batteries away if you do not use the device for a long time.
 - Charge the batteries with the supplied battery charger for more than 4 hours before first use.
 - The battery type is 18650 with the protection board, and the battery size should be within 19 mm × 70 mm. The rated voltage and capacity are 3.6 VDC/3.2 Ah.
-

2.2 Cable Connection

Connect the device and power adaptor with a type-C cable to power on or charge the device. Alternatively, connect the device and PC to export files.

Steps

1. Lift the type-C interface cover.
2. Connect the device and power adapter with a type-C cable to charge the device.

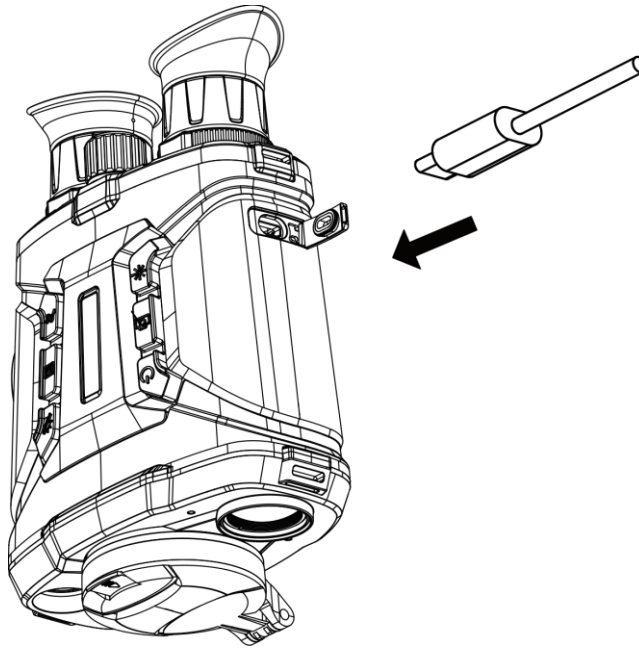

Figure 2-4 Cable Connection

 **Note**

- Please charge the device after the batteries are installed in the battery compartment of the device.
 - The charging temperature should be from 0 °C to 45 °C (32 °F to 113 °F).
 - You can use battery charger to charge the batteries.
-

2.3 Mount Neck Strap

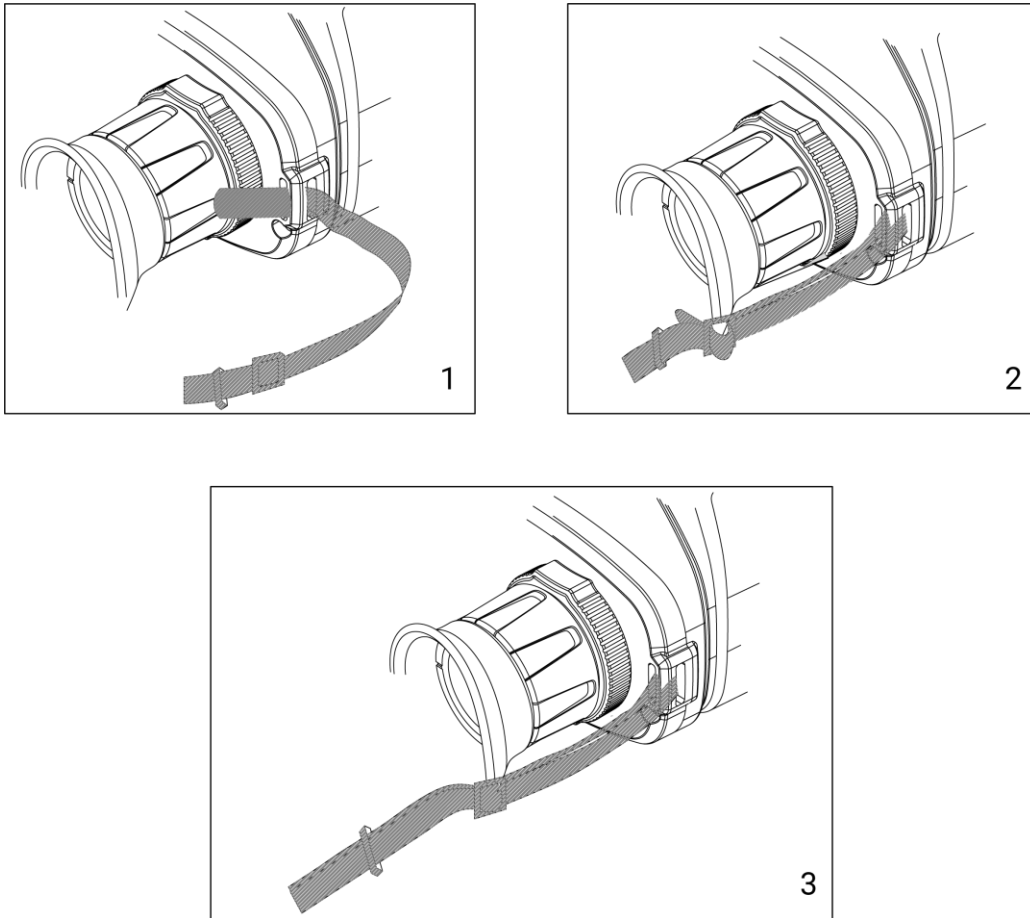



Figure 2-5 Mount Neck Strap

 **Note**

Refer to the figure above to mount the hand strap.

2.4 Power On/Off

Power On

When the battery is sufficiently charged or connected to power supply, hold  to power on the device.













Power Off

When the device is turned on, hold  to power off the device.



Auto Power Off

Set the auto power off time for your device, and then the device will automatically shut down if there is no any operation after the set time.

Steps

1. Hold  to go to the menu.
2. Press  or  to select  **General Settings**.
3. Press  or  to select , and press  to enter the configuration interface.
4. Press  or  to select the auto power off time as needed, and press  to confirm.
5. Hold  to save and exit.







Note

- See the battery icon for the battery status.  means the battery is fully charged, and  means that the battery is low.
 - When the low power note shows, charge the battery.
 - The auto power off countdown will start again when the device reenters the standby mode or the device is restarted.
-

2.5 Auto Screen Off

Auto screen off function darkens the screen to save energy and extend battery life. However, the device stays on and you can view the live view on HIKMICRO Sight app when connecting the device to the app.

Steps

1. Enable auto screen off.
 - 1). Hold  to show the menu.
 - 2). Press  or  to select .
 - 3). Press  to enable auto screen off.
 - 4). Hold  to save settings and exit.
2. In one of the following conditions, the device will enter the standby mode when you hold it close to your eyes and the display is turned on:
 - Tilt the device downwards more than 70°.
 - Rotate the device horizontally more than 70°.
3. In one of the following conditions, the device will wake up when it's put close to your eyes but the display is turned off:
 - Tilt the device downwards from 0° to 60° or upwards .
 - Rotate the device horizontally from 0° to 70°.

2.6 Menu Description

In the live view interface, hold  to show the menu.

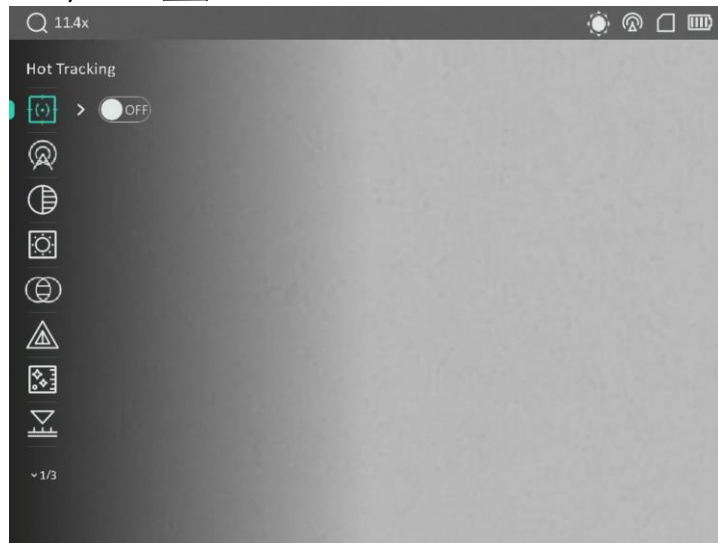





Figure 2-6 Menu Interface

- Press  to move the cursor up.
- Press  to move the cursor down.
- Press  to confirm and hold it to exit the menu.

2.7 App Connection

Connect the device to the HIKMICRO Sight app via hotspot, then you can capture picture, record video, or configure parameters on your phone.

Steps









1. Search the HIKMICRO Sight on App Store (iOS System) or Google Play™ (Android System) to download it, or scan the QR code to download and install the app.



Android System



iOS System

2. Hold  to show the menu.
3. Press  or  to select , and press  to confirm.
4. Press  or  to select **Hotspot** and press  to confirm.

- Turn on the WLAN of your phone and connect to the hotspot.
 - Hotspot Name: HIK-IPTS Serial No.
 - Hotspot Password: Serial No.
- Open the app and connect your phone with the device. You can view the interface of device on your phone.

Note

- The device cannot connect to the app if you enter wrong password several times. Refer to **Restore Device** to reset the device, and connect the app again.
 - The device should be activated for the first use.
-

2.8 Firmware Status

2.8.1 Check Firmware Status

Steps

- Open the HIKMICRO Sight and connect your device to the app.
- Check if there is an upgrade prompt on the device management interface. If there is no upgrade prompt, the firmware is the latest version. Otherwise, the firmware is not the latest version.

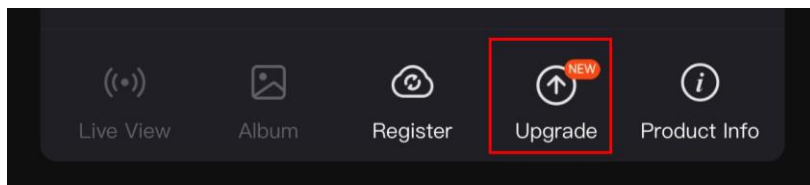

Figure 2-7 Check Firmware Status

- (Optional) If the firmware is not the latest version, upgrade the device. See **Upgrade Device**.

2.8.2 Upgrade Device

Upgrade Device via HIKMICRO Sight

Before You Start

Install HIKMICRO Sight on your phone and connect your device to the app.

Steps

1. Tap the upgrade prompt to enter the firmware upgrade interface.
2. Tap **Upgrade** to start upgrade.

Note

The upgrading operation may vary due to app updates. Please take the actual app version for reference.

Upgrade Device via PC

Before You Start

Please get the upgrade package first.

Steps

1. Connect the device to your PC with cable.
2. Open the detected disk, copy the upgrade file and paste it to the root directory of the device.
3. Disconnect the device from your PC.
4. Reboot the device.

Result

The device upgrades automatically. The upgrading process will be displayed in the interface.

Chapter 3 Image Settings

3.1 Adjust Device

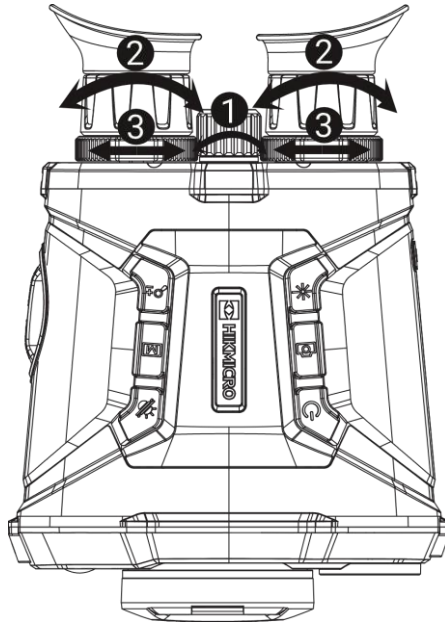

Figure 3-1 Adjust Device

① Adjust Focus

Slightly rotate the focus ring to adjust the focus of the objective lens.

Note

- DO NOT touch the lens directly with your finger, or place any sharp objects near them.
 - Only the focus of the thermal lens can be adjusted with the focus ring.
-

② Adjust Diopter

Make sure the eyepiece covers your eye and aim at the target. Adjust the diopter adjustment ring until the OSD text or image is clear.

Note









When adjusting diopter, DO NOT touch the surface of lens to avoid smearing the lens.

③ Adjust Interpupillary Distance

Adjust the interpupillary distance by moving the eyepieces farther or closer to each other.









3.2 Adjust Brightness

Steps

1. Hold  to show the menu.
2. Press  or  to select  and press  to confirm.
3. Press  or  to adjust display brightness.
4. Hold  to save settings and exit.

3.3 Adjust Contrast

Steps

1. Hold  to show the menu.
2. Press  or  to select  and press  to confirm.
3. Press  or  to adjust display brightness.
4. Hold  to save settings and exit.

3.4 Adjust Tone

Steps

















1. Hold  to show the menu.
2. Press  or  to select  and press  to confirm.
3. Press  or  to select a tone. **Warm** and **Cold** can be selected.
4. Hold  to save and exit.



Figure 3-2 Adjust Tone

3.5 Adjust Sharpness

Steps

1. Hold  to show the menu.
2. Press  or  to select  and press  to confirm.
3. Press  to confirm, and press  or  to adjust sharpness.
4. Hold  to save and exit.

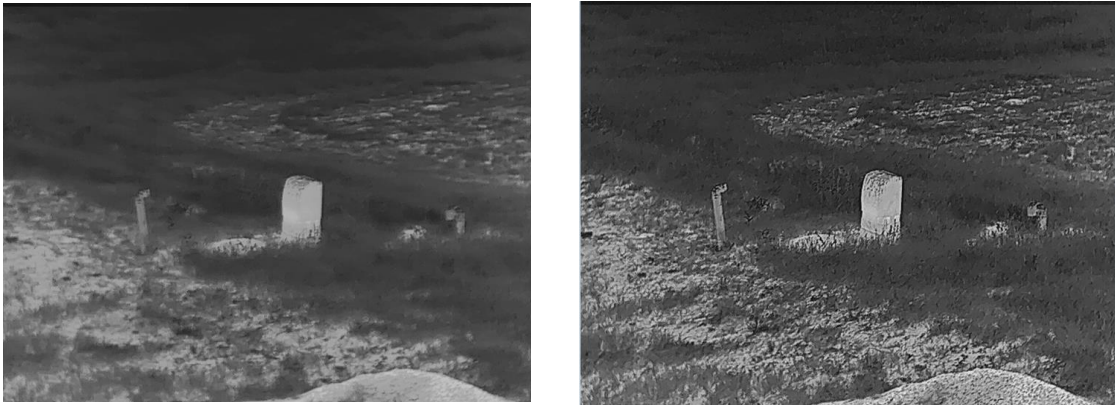











Figure 3-3 Sharpness Comparison

3.6 Select Scene

You can select proper scene according to actual using scene to improve the display effect.

Steps









1. Hold  to show the menu.
2. Press  or  to select  and press  to confirm.
3. Press  to enter the setting interface.
4. Press  or  to switch scene.
 - **Recognition:** Recognition refers to recognition mode and is recommended in normal scene.
 - **Jungle:** Jungle refers to jungle mode and is recommended in hunting environment.
5. Hold  to save settings and exit.

3.7 Set Palettes

Press  in live view interface to switch palettes, so as to display the same scene in different effects.



You can custom the palettes as needed by the following steps.

Steps

1. Hold  to go to the menu.
 2. Press  or  to select  and press  to confirm.
 3. Press  or  to select the palettes as needed, and press  to enable it/them.
-

Note

- At least one palette should be enabled.
 - All the palettes are enabled in default.
-

4. Hold  to save the settings and exit.
5. Press  in live view interface to switch the selected palettes.

Optical

The image of optical channel is displayed in this mode.

White Hot

The hot part is light-colored in view. The higher the temperature is, the lighter the color is.



Black Hot

The hot part is black-colored in view. The higher the temperature is, the darker the color is.



Red Hot

The hot part is red-colored in view. The higher the temperature is, the redder the color is.



Fusion

From high temperature to low temperature, the image is colored in from white, yellow, red, pink to purple.











Image Fusion

Fuse the optical image with the thermal image. The fused image with clear edge is displayed in this mode.

3.8 Set Fusion Level

When the palette is set as image fusion, you can adjust the fusion level according to the actual observation distance to obtain better image fusion effect.





Steps

1. Hold  to show the menu.
2. Press  or  to select  and press  to confirm.
3. Press  or  to switch fusion level and press  to confirm.
4. Hold  to save the settings and exit.

3.9 Set Display Mode

In optical mode, you can select different display modes in different scenes.

Press  in live view interface to switch display modes. Day, night, defog, and auto are selectable.

- : Day mode. You can use this mode at daytime and in bright environment. In day mode, the IR light is off automatically.
- : Night mode. You can use this mode at nights and in bright environment. In day mode, the IR light is on automatically.
- : Auto mode. The day mode and night mode switch automatically according to the ambient brightness.
- : Defog mode. You can use this mode in foggy days.

3.10 Adjust Digital Zoom

You can zoom in and out the image by using this function. Press  in the live view interface, the digital zoom ratio switches between 1×, 2×, 4×, 8× and 16×.

Note

When switching the digital zoom ratio, the top-left corner of interface displays the actual magnification (Actual Magnification = Lens Optical Magnification × Digital Zoom Ratio). For example, the lens optical magnification is 5.7× and the digital zoom ratio is 2×, and the actual magnification is 11.4×.

3.11 Set Picture in Picture



Hold  in live view mode to enable PIP, and hold  again to exit PIP. The image center is displayed in upper middle of the interface.



Figure 3-4 Picture in Picture Mode















Note

If the PIP function is enabled, only the PIP view zooms when adjusting the digital zoom ratio.

3.12 Flat Field Correction

This function can correct non-uniformity of display.

Steps

1. Hold  to show the menu.
2. Press  or  to select  **Function Settings** and press  to confirm.
3. Press  or  to select , and press  to enter the configuration interface.
4. Press  or  to switch FFC mode.
 - **Manual FFC:** Hold  in the live view to correct the non-uniformity of display.
 - **Auto FFC:** The device performs FFC automatically according to the set schedule when switching on the camera.
 - **External:** Cover the lens cover, then hold  in the live view to correct the non-uniformity of display.
5. Hold  to save the settings and exit.















Note

The countdown will start before the device performs FFC automatically.

3.13 Correct Defective Pixel

The device can correct the defective pixels on the screen which are not performed as expected.

Steps

1. Hold  to show the menu.
 2. Press  or  to select  **Function Settings** and press  to confirm.
 3. Press  or  to select  , and press  to enter DPC configuration interface.
 4. Press  to select **X** or **Y Axis**. If you select **X** axis, the cursor moves left and right; if you select **Y** axis, the cursor moves up and down.
 5. Press  or  to set the coordinates until the cursor reaches the defective pixel.
 6. Press  twice to correct the dead pixel.
 7. Hold  to save the settings and exit.
-









Note

- The selected defective pixel can be magnified and displayed at the bottom right of the interface.
 - If the screen OSD blocks the defective pixel, move the cursor to reach the defective pixel, then the device performs mirror display automatically.
-

3.14 Set Infrared Light

The infrared light helps to view targets clearly in low light.

Steps

1. Hold  to show the menu.
 2. Press  or  to select  and press  to confirm.
 3. Press  or  to select **Smart IR** or set the emission level of infrared light. If you need to turn off the infrared light, select **OFF**.
 4. Hold  to save the settings and exit.
-

Note

- When enabled, the infrared light only works in night mode, or in auto mode and the
-







ambient light is insufficient.

- Image overexposure may occur in too bright environment. **Smart IR** helps to adjust the overexposed images by controlling infrared light intensity, so as to improve the image effect in night mode and dark environment.
 - Infrared light cannot be turned on if the battery is low.
-

3.15 Image Pro

Image pro refers to image detail enhancement. When you enable this function, the details of whole live view interface will be enhanced.

Steps

1. Hold  to show the menu.
2. Press  or  to select  and press  to enable this function.
3. Hold  to return to the live view interface, and view the target.







Result

The details of the whole live view image will be enhanced.

3.16 Zoom Pro

Zoom Pro refers to zoomed image detail enhancement. When you turn on this function, the details of zoomed live view image will be enhanced.

Steps

1. Hold  to show the menu.
2. Press  or  to select .
3. Press  to enable the function.
4. Hold  to save settings and exit.

Result

The details of the zoomed live view image will be enhanced.

Note

If the PIP function is enabled, zoom pro is only enabled in the PIP view.











Chapter 4 Measure Distance

The device can detect the distance between the target and the observation position with laser.

Before You Start

When measuring the distance, keep the device steady for an accurate result.

Steps



1. Hold  to show the menu.
2. Press  or  to select  and press  to confirm.
3. Press  or  to select a continuous laser ranging mode. Press  to confirm.
4. Hold  to save the setting and return to the live view interface.
5. Aim the cursor at the target and press  to measure the target distance once or hold  to measure the distance continuously.

Note

Laser ranging cannot be enabled when device battery is low.

Result

The distance measurement result is displayed at the upper right of the image.

Measurement successful:  LRF: 14 yard ; measurement failed:  LRF: ~~yard~~ .

Caution













The laser radiation emitted from the device can cause eye injuries, burning of skin or inflammable substances. Before enabling the laser ranging function, make sure no human or inflammable substances are in front of the laser lens.

Chapter 5 General Settings

5.1 Set OSD

This function can display or hide the OSD information on the live view interface.

Steps

1. Hold  to show the menu.
2. Press  or  to select  **Function Settings**.
3. Press  or  to select , and press  to enter OSD setting interface.
4. Press  or  to select the **Time, Date, or OSD**, and press  to turn on or turn off the selected OSD information.
5. Hold  to save and exit.









Note

If you turn off **OSD**, all OSD information on the live view will not be displayed.

5.2 Set Brand Logo

You can add brand logo to the live view interface, snapshots, and videos.

Steps

1. Hold  to show the menu.
2. Press  or  to select  **Function Settings**.
3. Press  or  to select .
4. Press  to enable **Brand Logo**.
5. Hold  to save the settings and exit.









Result

The brand logo is displayed at the bottom left of the image.

5.3 Burning Prevention

Enable burning prevention to reduce the risk of sensor damage from the heat such as direct sunlight.

Steps

1. Hold  to show the menu.
2. Press  or  to select  **Function Settings**.
3. Press  or  to select .
4. Press  to enable or disable the **Burn-Prevention** function.
5. Hold  to save settings and exit.

5.4 Capture and Video

You can manually record video or capture picture when displaying live view.

5.4.1 Capture Picture

In live view mode, press  to capture a picture.

Note







When capturing succeeds, the image freezes for 1 second and a prompt shows on the display.

For exporting captured pictures, refer to *Export Files*.

5.4.2 Set Audio

If you enable the audio function, the sound will be recorded with the video. When there is too loud noise in the video, you can disable the audio.

Steps

1. Hold  to show the menu.
2. Press  or  to select .
3. Press  to enable or disable the audio.
5. Hold  to save and exit.

5.4.3 Record Video

Steps

1. In live view mode, hold  and start recording.

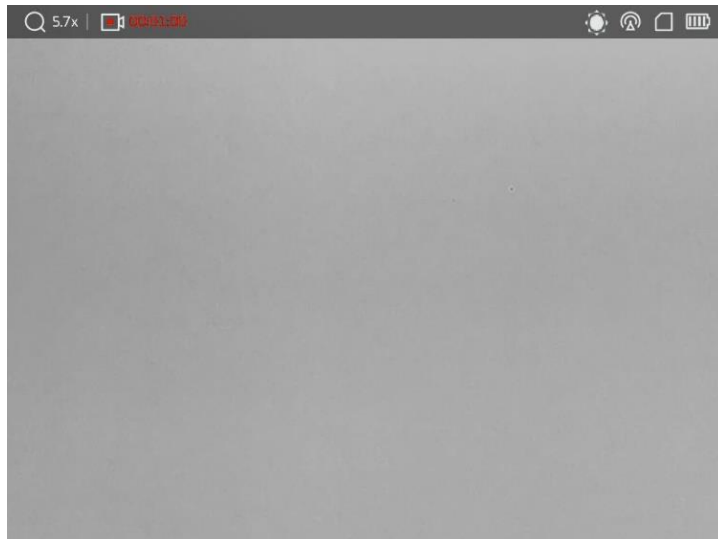

Figure 5-1 Start Recording

The left top of image displays the recording time.

2. Hold  again to stop recording.



What to do next

For exporting recording files, refer to *Export Files*.

5.4.4 View Local Files







Captured images and recorded videos are automatically stored in the device, and you can view the files in local albums.

Steps







1. Hold  to show the menu.
2. Press  or  to select  and press  to enter **Albums**.

Note

The albums are automatically created and named by year + month. The local pictures and videos of a certain month are stored in the corresponding album. For example, the pictures and videos of August in 2022 are saved in the album named 202208.

3. Press  or  to select the album storing the files, and press  to enter the selected album.
4. Press  or  to select a file to view.
5. Press  to view the selected file and relevant information.

Note

- Files are arranged in chronological order, with the most recent at the top. If you fails to find the most recently taken snapshots or videos, please check the time and date settings of your device. See ***Synchronize Time*** for instructions. When you are viewing files, you can switch to other files by pressing  or , turn pages by pressing , and return to the previous page by pressing .
 - When you are viewing videos, you can press  to play or stop the video.
 - For deleting an album or a file, you can hold  to call the dialogue box, and delete the album or file according to the prompt.
 - For file exporting, see ***Export Files*** for instructions.
-

5.5 Export Files

5.5.1 Export Files via HIKMICRO Sight

You can access device albums and export files to your phone via HIKMICRO Sight.

Before You Start

Install HIKMICRO Sight on your mobile phone.

Steps

1. Open HIKMICRO Sight and connect your device to the app. See ***App Connection***.
2. Tap **Media** to access device albums.

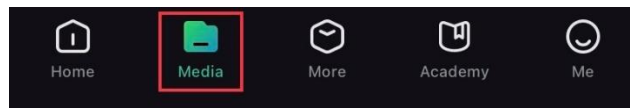

Figure 5-2 Access Device Albums

3. Tap **Local** or **Device** to view the photos and videos.
 - **Local**: You can view the files captured on app.
 - **Device**: You can view the files of the current device.

Note

The photos or videos may not show in **Device**. Please pull down to refresh the page.

4. Tap to select a file, and tap **Download** to export the file to your local phone albums.



Figure 5-3 Export Files

Note

- Go to **Me -> About -> User Manual** on the app to see more detailed operations.
- You can also access device albums by tapping bottom left icon in the live view interface.

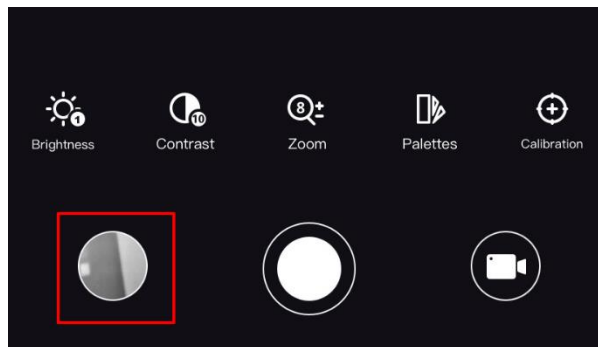

Figure 5-4 Access Device Albums

- The exporting operation may vary due to app updates. Please take the actual app version for reference.
-

5.5.2 Export Files via PC

This function is used to export recorded videos and captured pictures.

Steps

1. Connect the device and PC with cable.

Note

Make sure the device is turned on when connecting the cable.

2. Open computer disk and select the disk of device. Go to the DCIM folder and find the folder named after the capture year and month. For example, if you capture a picture or record a video on June 2023, go to **DCIM -> 202306** to find the picture or video.
 3. Select and copy the files to PC.
 4. Disconnect the device from your PC.
-

Note

- The device displays images when you connect it to PC. But functions such as recording, capturing and hotspot are disabled.
 - When you connect the device to PC for the first time, it installs the drive program automatically.
-









5.6 CVBS Video Output

With CVBS video output, you can debug the device or view the device image on an external display unit for details.

Before You Start

Connect the device to the display unit via a USB Type-C to CVBS interface cable.

Steps

1. Hold  to show the menu.
 2. Press  or  to select  **Function Settings** and press  to confirm.
 3. Press  or  to select  and press  switch on CVBS.
 4. View the device image on the external display unit.
-





Note

The Type-C to CVBS cable is not included in the package.

5.7 Hot Tracking

The device can detect the highest temperature spot in the scene and mark it on display.

Steps

1. Hold  to show the menu.
2. Press  or  to select .
3. Press  to mark the spot of highest temperature.

Result



When the function is enabled,  displays in the spot of highest temperature. When the scene changes, the  moves.















Figure 5-5 Hot Tracking

5.8 Direction Display

5.8.1 Switch on Compass

Equipped with a compass, the device is able to display its direction and pitch angle on the live image, captured images, and recorded videos.

Steps

1. Hold  to show the menu.
2. Press  or  to select  **Function Settings** and press  to confirm.
3. Press  or  to select  and press  to confirm.
4. Press  or  to select **Compass** and press  to switch it on.
5. Hold  to save and exit.

Note

- The compass needs to be calibrated for the first use and a calibration prompt will appear. Refer to **Compass Calibration** for the details.
- After turning on the compass, the current direction and pitch angle will be displayed at the top right of the live view interface.



AZM: 76.4°
EL: -35.8°

Figure 5-6 Compass Normal



5.8.2 Compass Calibration

You need to calibrate the compass when you enable the function for the first time, or when the compass is magnetically interfered, and the direction information displays red.



Figure 5-7 Compass Abnormal

Steps

1. Call the calibration guide by either of the following ways.
 - When you enable compass for the first time, the compass calibration guide pops up.
 - When the compass information displays red, select  in the menu and press  to re-enable the compass.
2. Follow the screen instructions to move and rotate the device.

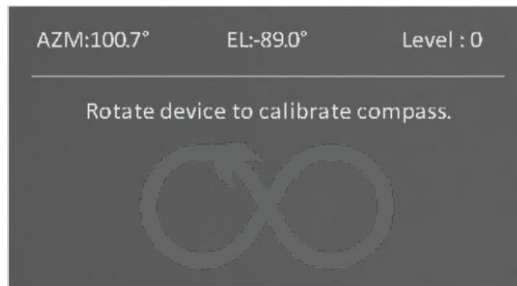

Figure 5-8 Compass Calibration

Note

- During calibration, keep moving and rotating the device to make sure that the device faces every possible directions.
 - Calibration **Level** indicates the validity of calibration. Higher level means more accurate compass reading. Calibration succeeds when the **Level** turns to **3**.
-

















3. Stop moving the device when calibration success message pops up.

5.8.3 Magnetic Declination Correction

Magnetic declination is the angle variation between magnetic north and true north. Adding the magnetic declination to the compass increase the accuracy of direction reading.

Steps

1. Hold  to show the menu.
-

2. Press  or  to select  **Function Settings** and press  to confirm.
3. Press  or  to select  and press  to confirm.
4. Press  or  to select **Magnetic Declination**.
5. Press  or  to select **Quick Correction** or **Manual Correction**.
 - In quick correction, the device display the current declination to magnetic north. Point screen center to true north and press .
 - In manual correction, press  to select the operational symbol or number, and  or  to add or subtract the declination of device location.

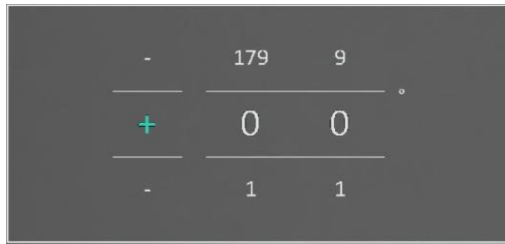



Figure 5-9 Magnetic Declination Correction

6. Hold  to save and exit.

Note

Please check the local magnetic declination information on an authoritative website before manual correction. The magnetic declination of east is (+) and west is (-). For example, if the magnetic declination of Shanghai is 5°30'W, set the value to -5.5°.

5.9 Geographic Location Display









Note

- The satellite module is not able to receive signals when the device is indoor. Place the device in an outdoor open space to receive signals.
 - In an outdoor space, wait for a moment for the device to obtain its location.
-

5.9.1 Device Location Display

Equipped with satellite positioning modules, the device is able to display the longitude and latitude, as well as the sea level altitude of the device on the live image, captured images, and recorded videos.

Steps

1. Hold  to show the menu.
2. Press  or  to select  **Function Settings** and press  to confirm.
3. Press  or  to select  and press  to turn it on.
4. Hold  to save and exit.

Result

The location information of the current device position is displayed at the bottom right of the live view interface.

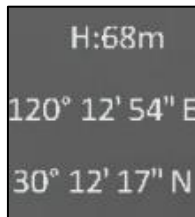
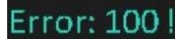

Figure 5-10 Device Location Display

Note

If the error code "100" is prompted at the device location information, it means that there is no GPS signal or the signal is weak. Please move to an outdoor open space and try again. The device will update the location information within 3 minutes.



A screenshot of a location error message that reads "Error: 100!".

Figure 5-11 Location Error

5.9.2 Target Location Display

Display the longitude and latitude, as well as the sea level altitude of the target on the live image, captured images, and recorded videos.

Before You Start

- The compass, laser ranging and GPS functions have been turned on and set.
- Completed compass calibration to level 3, and in an outdoor open space.

Press or hold  to measure the distance to the target. If measurement successful, the latitude, longitude and elevation of the target will be displayed at the bottom right of the live view interface.

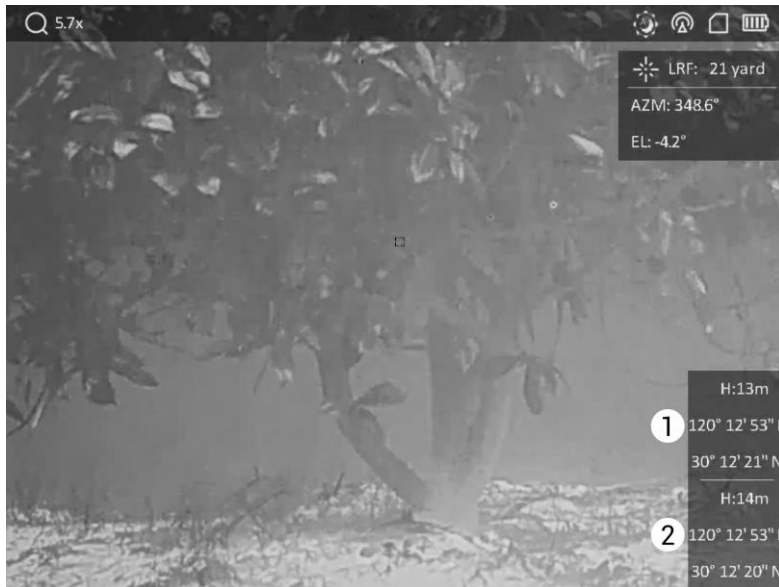

1: Target location; 2: Device location.

Figure 5-12 Target Location Display

Note

If "Error: XXX!" is prompted and the target positioning information cannot be acquired, please check the error code according to the following table. For example, as shown in the following figure: Error code "110" indicates that the GPS signal is weak or no signal, the compass calibration level has not reached to level 3, but the laser ranging is successful.

Error: 110!

Figure 5-13 Target Positioning Error













Table 5-1 Location Error Code Description

Error Code	Description	Solution
1 st Digit	<ul style="list-style-type: none"> • "0": GPS signal is normal. • "1": GPS signal is weak or no signal. 	Move the device to an outdoor open space.
2 nd Digit	<ul style="list-style-type: none"> • "0": Compass calibration is normal. • "1": Compass calibration has not reached level 3. 	Refer to <i>Compass Calibration</i> to calibrate the compass to level 3.
3 rd Digit	<ul style="list-style-type: none"> • "0": Ranging successful • "1": Ranging failure 	Select a suitable target for re-ranging.

Chapter 6 System Settings

















6.1 Adjust Date

Steps

1. Hold  to show the menu.
2. Press  or  to select  **General Settings**.
3. Press  or  to select .
4. Press  to enter the configuration interface.
5. Press  to select the year, month, or day, and press  or  to change the number.
6. Hold  to save settings and exit.

6.2 Synchronize Time





Steps









1. Hold  to show the menu.
2. Press  or  to select  **General Settings**.
3. Press  or  to select .
4. Press  to enter the configuration interface.
5. Press  or  to switch the clock system. 24-hour and 12-hour clock are selectable. If you select 12-hour clock, press , and then press  or  to select AM or PM.
6. Press  to select the hour or minute, and press  or  to change the number.
7. Hold  to save settings and exit.

6.3 Set Language

You can select the device language in this function.

Steps











1. Hold  to show the menu.
2. Press  or  to select  **General Settings**.

3. Press  or  to select .
4. Press  to enter the language configuration interface.
5. Press  or  to select the language as needed, and press  to confirm.
6. Hold  to save settings and exit.

6.4 Set Unit









You can switch the unit for distance measurement.

Steps

1. Hold  to show the menu.
2. Press  or  to select  **General Settings**.
3. Press  or  to select .
4. Press  to enter the unit setting interface. Press  or  to select the unit as needed.
5. Hold  to save settings and exit.









6.5 View Device Information

Steps

1. Hold  to show the menu.
2. Press  or  to select  **General Settings**.
3. Press  or  to select .
4. Press  to confirm. You can view the device information such as firmware version and serial No.
5. Hold  to save settings and exit.

6.6 Restore Device

Steps

1. Hold  to show the menu.
2. Press  or  to select  **General Settings**.
3. Press  or  to select .
4. Press  to restore the device to defaults according to the prompt.

Chapter 7 Frequently Asked Questions

7.1 Why does the charge indicator flash improperly?

Check the following items.

- Check whether the device is charged with standard power adapter and the charging temperature is above 0 °C (32 °F).
- The device is equipped with built-in charging protection module. Charge the device in power off status.

7.2 Why is the power indicator off?

Check whether the device is off-battery. Check the indicator after charging the device for 5 minutes.

7.3 The image is not clear, how to adjust it?

Adjust the diopter adjustment ring or focus ring until the image is clear. Refer to *Adjust Device*.

7.4 Capturing or recording fails. What's the problem?

Check the following items.

- Whether the device is connected to your PC. Capturing or recording is disabled in this status.
- Whether the storage space is full.
- Whether the device is low-battery.

7.5 Why the PC cannot identify the device?

Check the following items.

- Whether the device is connected to your PC with supplied USB cable.
- If you use other USB cables, make sure the cable length is no longer than 1 m.

Safety Instruction



These instructions are intended to ensure that user can use the product correctly to avoid danger or property loss. Please read all the safety information carefully before using.

Laws and Regulations

Use of the product must be in strict compliance with the local electrical safety regulations.

Symbol Conventions

The symbols that may be found in this document are defined as follows.

Symbol	Description
 Danger	Indicates a hazardous situation which, if not avoided, will or could result in death or serious injury.
 Caution	Indicates a potentially hazardous situation which, if not avoided, could result in equipment damage, data loss, performance degradation, or unexpected results.
 Note	Provides additional information to emphasize or supplement important points of the main text.

Transportation

- Keep the device in original or similar packaging while transporting it.
- Keep all wrappers after unpacking them for future use. In case of any failure occurred, you need to return the device to the factory with the original wrapper. Transportation without the original wrapper may result in damage on the device and the company shall not take any responsibilities.
- Do not drop the product or subject it to physical shock. Keep the device away from magnetic interference.

Power Supply

- Input voltage should meet the Limited Power Source (5 VDC, 2 A) according to the IEC61010-1 or IEC 62368-1 standard. Please refer to technical specifications for detailed information.
- Make sure the plug is properly connected to the power socket.
- DO NOT connect multiple devices to one power adapter, to avoid over-heating or fire hazards caused by overload.
- The power source should meet limited power source or PS2 requirements according to IEC 62368-1 standard.

Battery

- The external rechargeable battery type is 18650, and the battery size should be 19 mm × 70 mm. The rated voltage and capacity are 3.6 VDC/3200 mAh.
- For long-term storage of the battery, make sure it is fully charged every half year to ensure the battery quality. Otherwise, damage may occur.
- Use the battery provided by qualified manufacturer. Refer to the product specification for detailed battery requirements.
- CAUTION: Risk of explosion if the battery is replaced by an incorrect type.
- Improper replacement of the battery with an incorrect type may defeat a safeguard (for example, in the case of some lithium battery types).
- Do not dispose of the battery into fire or a hot oven, or mechanically crush or cut the battery, which may result in an explosion.
- Do not leave the battery in an extremely high temperature surrounding environment, which may result in an explosion or the leakage of flammable liquid or gas.
- Do not subject the battery to extremely low air pressure, which may result in an explosion or the leakage of flammable liquid or gas.
- Dispose of used batteries according to the instructions.
- Confirm there is no flammable material within 2 m of the charger during charging.
- DO NOT place the battery in the reach of children.
- DO NOT swallow the battery to avoid chemical burns.

Maintenance

- If the product does not work properly, please contact your dealer or the nearest service center. We shall not assume any responsibility for problems caused by unauthorized repair or maintenance.
- Wipe the device gently with a clean cloth and a small quantity of ethanol, if necessary.
- If the equipment is used in a manner not specified by the manufacturer, the protection provided by the device may be impaired.
- Clean the lens with soft and dry cloth or wiping paper to avoid scratching it.

Using Environment

- Make sure the running environment meets the requirement of the device. The operating temperature shall be -30 °C to 55 °C (-22 °F to 131 °F), and the operating humidity shall be from 5% to 95%.
- DO NOT expose the device to high electromagnetic radiation or dusty environments.
- DO NOT aim the lens at the sun or any other bright light.
- Place the device in a dry and well-ventilated environment.
- Avoid equipment installation on vibratory surface or places subject to shock (neglect may cause equipment damage).

Emergency

- If smoke, odor, or noise arises from the device, immediately turn off the power, unplug the power cable, and contact the service center.

Laser

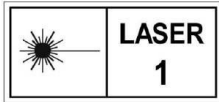

When any laser equipment is in use, make sure that the device lens is not exposed to the laser beam, or it may burn out. The laser radiation emitted from the device can cause eye injuries, burning of skin or inflammable substances. Before enabling the laser ranging function, make sure no human or inflammable substances are in front of the laser lens. Do not place the device where minors can fetch it. The wavelength is 905 nm, and the max. power output is less than 1.328 mW. According to IEC 60825-1:2014 and EN 60825-1:2014+A11:2021, this laser product is classified as Class 1 laser product.

Manufacture Address

Room 313, Unit B, Building 2, 399 Danfeng Road, Xixing Subdistrict, Binjiang District,
Hangzhou, Zhejiang 310052, China
Hangzhou Microimage Software Co., Ltd.

COMPLIANCE NOTICE: The thermal series products might be subject to export controls in various countries or regions, including without limitation, the United States, European Union, United Kingdom and/or other member countries of the Wassenaar Arrangement. Please consult your professional legal or compliance expert or local government authorities for any necessary export license requirements if you intend to transfer, export, re-export the thermal series products between different countries.

Legal Information

©2023 Hangzhou Microimage Software Co., Ltd. All rights reserved.

About this Manual

The Manual includes instructions for using and managing the Product. Pictures, charts, images and all other information hereinafter are for description and explanation only. The information contained in the Manual is subject to change, without notice, due to firmware updates or other reasons. Please find the latest version of this Manual at the HIKMICRO website (www.hikmicrotech.com).

Please use this Manual with the guidance and assistance of professionals trained in supporting the Product.

Trademarks Acknowledgement



and other HIKMICRO's trademarks and logos are the properties of HIKMICRO in various jurisdictions.

Other trademarks and logos mentioned are the properties of their respective owners.

LEGAL DISCLAIMER

TO THE MAXIMUM EXTENT PERMITTED BY APPLICABLE LAW, THIS MANUAL AND THE PRODUCT DESCRIBED, WITH ITS HARDWARE, SOFTWARE AND FIRMWARE, ARE PROVIDED "AS IS" AND "WITH ALL FAULTS AND ERRORS". HIKMICRO MAKES NO WARRANTIES, EXPRESS OR IMPLIED, INCLUDING WITHOUT LIMITATION, MERCHANTABILITY, SATISFACTORY QUALITY, OR FITNESS FOR A PARTICULAR PURPOSE. THE USE OF THE PRODUCT BY YOU IS AT YOUR OWN RISK. IN NO EVENT WILL HIKMICRO BE LIABLE TO YOU FOR ANY SPECIAL, CONSEQUENTIAL, INCIDENTAL, OR INDIRECT DAMAGES, INCLUDING, AMONG OTHERS, DAMAGES FOR LOSS OF BUSINESS PROFITS, BUSINESS INTERRUPTION, OR LOSS OF DATA, CORRUPTION OF SYSTEMS, OR LOSS OF DOCUMENTATION, WHETHER BASED ON BREACH OF CONTRACT, TORT (INCLUDING NEGLIGENCE), PRODUCT LIABILITY, OR OTHERWISE, IN CONNECTION WITH THE USE OF THE PRODUCT, EVEN IF HIKMICRO HAS BEEN ADVISED OF THE POSSIBILITY OF SUCH DAMAGES OR LOSS.

YOU ACKNOWLEDGE THAT THE NATURE OF THE INTERNET PROVIDES FOR INHERENT SECURITY RISKS, AND HIKMICRO SHALL NOT TAKE ANY RESPONSIBILITIES FOR ABNORMAL OPERATION, PRIVACY LEAKAGE OR OTHER DAMAGES RESULTING FROM CYBER-ATTACK, HACKER ATTACK, VIRUS INFECTION, OR OTHER INTERNET SECURITY RISKS; HOWEVER, HIKMICRO WILL PROVIDE TIMELY TECHNICAL SUPPORT IF REQUIRED. YOU AGREE TO USE THIS PRODUCT IN COMPLIANCE WITH ALL APPLICABLE LAWS, AND YOU ARE SOLELY RESPONSIBLE FOR ENSURING THAT YOUR USE CONFORMS TO THE APPLICABLE LAW. ESPECIALLY, YOU ARE RESPONSIBLE, FOR USING THIS PRODUCT IN A MANNER THAT DOES NOT INFRINGE ON THE RIGHTS OF THIRD PARTIES, INCLUDING

Thermal Binocular User Manual

WITHOUT LIMITATION, RIGHTS OF PUBLICITY, INTELLECTUAL PROPERTY RIGHTS, OR DATA PROTECTION AND OTHER PRIVACY RIGHTS. YOU SHALL NOT USE THIS PRODUCT FOR ILLEGAL HUNTING ANIMALS, INVASION OF PRIVACY OR ANY OTHER PURPOSE WHICH IS ILLEGAL OR DETRIMENTAL TO THE PUBLIC INTEREST. YOU SHALL NOT USE THIS PRODUCT FOR ANY PROHIBITED END-USES, INCLUDING THE DEVELOPMENT OR PRODUCTION OF WEAPONS OF MASS DESTRUCTION, THE DEVELOPMENT OR PRODUCTION OF CHEMICAL OR BIOLOGICAL WEAPONS, ANY ACTIVITIES IN THE CONTEXT RELATED TO ANY NUCLEAR EXPLOSIVE OR UNSAFE NUCLEAR FUEL-CYCLE, OR IN SUPPORT OF HUMAN RIGHTS ABUSES.

IN THE EVENT OF ANY CONFLICTS BETWEEN THIS MANUAL AND THE APPLICABLE LAW, THE LATTER PREVAILS.

Regulatory Information

These clauses apply only to the products bearing the corresponding mark or information.

FCC Information

Note: This product has been tested and found to comply with the limits for a Class B digital device, pursuant to Part 15 of the FCC Rules. These limits are designed to provide reasonable protection against harmful interference in a residential installation. This product generates, uses, and can radiate radio frequency energy and, if not installed and used in accordance with the instructions, may cause harmful interference to radio communications. However, there is no guarantee that interference will not occur in a particular installation. If this product does cause harmful interference to radio or television reception, which can be determined by turning the equipment off and on, the user is encouraged to try to correct the interference by one or more of the following measures:

- Reorient or relocate the receiving antenna.
- Increase the separation between the equipment and receiver.
- Connect the equipment into an outlet on a circuit different from that to which the receiver is connected.
- Consult the dealer or an experienced radio/TV technician for help.

Please take attention that changes or modification not expressly approved by the party responsible for compliance could void the user's authority to operate the equipment.

This device complies with Part 15 of the FCC Rules. Operation is subject to the following two conditions:

- (1) This device may not cause harmful interference, and
- (2) This device must accept any interference received, including interference that may cause undesired operation.

This equipment complies with FCC radiation exposure limits set forth for an uncontrolled environment.

Note: Due to the device size limit, the above statement may not be disclaimed on the device.

EU Compliance Statement



This product and - if applicable - the supplied accessories too are marked with "CE" and comply therefore with the applicable harmonized European standards listed under the Directive 2014/30/EU (EMCD), Directive 2014/35/EU (LVD), Directive 2011/65/EU (RoHS), Directive 2014/53/EU.

Hereby, Hangzhou Microimage Software Co., Ltd. declares that this device (refer to the label) is in compliance with Directive 2014/53/EU.

The full text of the EU declaration of conformity is available at the following internet address:

<https://www.hikmicrotech.com/en/support/download-center/declaration-of-conformity/>

Frequency Bands and Power (for CE)

The frequency bands and transmitting power (radiated and/or conducted) nominal limits applicable to the following radio equipment are as follows:

Wi-Fi 2.4 GHz (2.4 GHz to 2.4835 GHz), 20 dBm

For the device without a supplied power adapter, use the power adapter provided by a qualified manufacturer. Refer to the product specification for detailed power requirements.

For the device without a supplied battery, use the battery provided by a qualified manufacturer. Refer to the product specification for detailed battery requirements.



Directive 2012/19/EU (WEEE Directive): Products marked with this symbol cannot be disposed of as unsorted municipal waste in the European Union. For proper recycling, return this product to your local supplier upon the purchase of equivalent new equipment, or dispose of it at designated collection points. For more information see: www.recyclethis.info



Directive 2006/66/EC and its amendment 2013/56/EU (Battery Directive): This product contains a battery that cannot be disposed of as unsorted municipal waste in the European Union. See the product documentation for specific battery information. The battery is marked with this symbol, which may include lettering to indicate cadmium (Cd), lead (Pb), or mercury (Hg). For proper recycling, return the battery to your supplier or to a designated collection point. For more information see: www.recyclethis.info.

Industry Canada ICES-003 Compliance

This device meets the CAN ICES-003 (B)/NMB-003(B) standards requirements.

This device complies with Industry Canada license-exempt RSS standard(s). Operation is subject to the following two conditions:

(1) this device may not cause interference, and

(2) this device must accept any interference, including interference that may cause undesired operation of the device.

This equipment complies with IC RSS-102 radiation exposure limits set forth for an uncontrolled environment.

Conformité Industrie Canada ICES-003

Cet appareil répond aux exigences des normes CAN ICES-003 (B)/NMB-003 (B).

Cet appareil est conforme aux normes RSS exemptes de licence d'Industrie Canada. Son fonctionnement est soumis aux deux conditions suivantes :

(1) cet appareil ne doit pas causer d'interférences, et

(2) cet appareil doit accepter toute interférence reçue, notamment les interférences susceptibles d'occasionner un fonctionnement indésirable de l'appareil.

Cet appareil est conforme aux limites d'exposition au rayonnement IC RSS-102 établies pour un environnement non contrôlé.

KC

B급 기기: 이 기기는 가정용(B급) 전자파적합기기로서 주로 가정에서 사용하는 것을 목적으로 하며, 모든 지역에서 사용할 수 있습니다.

INFORMATIONEN FÜR PRIVATE HAUSHALTE

1. Getrennte Erfassung von Altgeräten:

Elektro- und Elektronikgeräte, die zu Abfall geworden sind, werden als Altgeräte bezeichnet. Besitzer von Altgeräten haben diese einer vom unsortierten Siedlungsabfall getrennten Erfassung zuzuführen. Altgeräte gehören insbesondere nicht in den Hausmüll, sondern in spezielle Sammel- und Rückgabesysteme.

2. Batterien und Akkus sowie Lampen:

Besitzer von Altgeräten haben Altbatterien und Altakkumulatoren, die nicht vom Altgerät umschlossen sind, die zerstörungsfrei aus dem Altgerät entnommen werden können, im Regelfall vor der Abgabe an einer Erfassungsstelle vom Altgerät zu trennen. Dies gilt nicht, soweit Altgeräte einer Vorbereitung zur Wiederverwendung unter Beteiligung eines öffentlich-rechtlichen Entsorgungsträgers zugeführt werden.

3. Möglichkeiten der Rückgabe von Altgeräten:

Besitzer von Altgeräten aus privaten Haushalten können diese bei den Sammelstellen der öffentlich-rechtlichen Entsorgungsträger oder bei den von Herstellern oder Vertreibern im Sinne des ElektroG eingerichteten Rücknahmestellen unentgeltlich abgeben.

Rücknahmepflichtig sind Geschäfte mit einer Verkaufsfläche von mindestens 400 m² für Elektro- und Elektronikgeräte sowie diejenigen Lebensmittelgeschäfte mit einer Gesamtverkaufsfläche von mindestens 800 m², die mehrmals pro Jahr oder dauerhaft Elektro- und Elektronikgeräte anbieten und auf dem Markt bereitstellen. Dies gilt auch bei Vertrieb unter Verwendung von Fernkommunikationsmitteln, wenn die Lager- und Versandflächen für Elektro- und Elektronikgeräte mindestens 400 m² betragen oder die

gesamten Lager- und Versandflächen mindestens 800 m² betragen. Vertreiber haben die Rücknahme grundsätzlich durch geeignete Rückgabemöglichkeiten in zumutbarer Entfernung zum jeweiligen Endnutzer zu gewährleisten. Die Möglichkeit der unentgeltlichen Rückgabe eines Altgerätes besteht bei rücknahmepflichtigen Vertreibern unter anderem dann, wenn ein neues gleichartiges Gerät, das im Wesentlichen die gleichen Funktionen erfüllt, an einen Endnutzer abgegeben wird.

4. Datenschutz-Hinweis:

Altgeräte enthalten häufig sensible personenbezogene Daten. Dies gilt insbesondere für Geräte der Informations- und Telekommunikationstechnik wie Computer und Smartphones. Bitte beachten Sie in Ihrem eigenen Interesse, dass für die Löschung der Daten auf den zu entsorgenden Altgeräten jeder Endnutzer selbst verantwortlich ist.

5. Bedeutung des Symbols „durchgestrichene Mülltonne“:



Das auf Elektro- und Elektronikgeräten regelmäßig abgebildete Symbol einer durchgestrichenen Mülltonne weist darauf hin, dass das jeweilige Gerät am Ende seiner Lebensdauer getrennt vom unsortierten Siedlungsabfall zu erfassen ist.



HIKMICRO

See the World in a New Way



Facebook: HIKMICRO Outdoor Instagram: hikmicro_outdoor

YouTube: HIKMICRO Outdoor

LinkedIn: HIKMICRO

Web: www.hikmicrotech.com

E-mail: support@hikmicrotech.com

UD36007B