



Digital Night Vision Scope

ALPEX Series

User Manual V5.5.76 202311



Contact Us

Table of Contents

| | |
|---------------------------------------|----|
| Chapter 1 Overview | 1 |
| 1.1 Device Description..... | 1 |
| 1.2 Main Function | 1 |
| 1.3 Appearance..... | 1 |
| Chapter 2 Preparation | 3 |
| 2.1 Cable Connection | 3 |
| 2.2 Install Battery | 3 |
| 2.2.1 Battery Instruction | 3 |
| 2.2.2 Battery Installation | 4 |
| 2.3 Mount Device on Rail | 4 |
| 2.4 Install IR Torch..... | 6 |
| 2.5 Power On/Off | 8 |
| 2.6 Menu Description | 9 |
| 2.7 App Connection | 9 |
| 2.8 Firmware Status | 10 |
| 2.8.1 Check Firmware Status | 10 |
| 2.8.2 Upgrade Device..... | 11 |
| 2.9 Zeroing | 12 |
| Chapter 3 Image Settings | 13 |
| 3.1 Adjust Diopter | 13 |
| 3.2 Adjust Focus | 13 |
| 3.3 Adjust Brightness | 14 |
| 3.4 Adjust Contrast..... | 14 |
| 3.5 Switch Day and Night..... | 14 |
| 3.6 Set Smart IR | 15 |
| 3.7 Set Picture in Picture Mode | 15 |
| 3.8 Adjust Digital Zoom..... | 15 |

| | |
|---|----|
| Chapter 4 Zeroing..... | 17 |
| 4.1 Select Zeroing Profile..... | 17 |
| 4.2 Set Reticle Style..... | 18 |
| 4.3 Correct Reticle..... | 18 |
| Chapter 5 Measure Distance | 20 |
| Chapter 6 General Settings | 21 |
| 6.1 Set OSD | 21 |
| 6.2 Set Brand Logo | 21 |
| 6.3 Capture and Video..... | 21 |
| 6.3.1 Capture Picture..... | 21 |
| 6.3.2 Set Audio..... | 22 |
| 6.3.3 Record Video..... | 22 |
| 6.3.4 Prerecord Video..... | 23 |
| 6.4 Export Files | 23 |
| 6.4.1 Export Files via HIKMICRO Sight..... | 23 |
| 6.4.2 Export Files via PC..... | 24 |
| Chapter 7 System Settings | 26 |
| 7.1 Adjust Date..... | 26 |
| 7.2 Synchronize Time..... | 26 |
| 7.3 Set Language..... | 26 |
| 7.4 Set Unit..... | 27 |
| 7.5 View Device Information..... | 27 |
| 7.6 Restore Device..... | 27 |
| Chapter 8 Frequently Asked Questions | 28 |
| 8.1 Why is the monitor off?..... | 28 |
| 8.2 The image is not clear, how to adjust it?..... | 28 |
| 8.3 Capturing or recording fails. What's the problem? | 28 |
| 8.4 Why the PC cannot identify the device? | 28 |

Digital Night Vision Scope User Manual

| | |
|------------------------------|----|
| Safety Instruction | 29 |
| Legal Information | 32 |
| Regulatory Information | 34 |

Chapter 1 Overview

1.1 Device Description

HIKMICRO ALPEX digital night vision scope can perform in all ambient light. It has an advanced HD sensor and a high resolution OLED display, which provides full-color clarity in daytime and classic black & white viewing at night. The traditional-style tube meets the needs of professional hunters who value traditions and seek technological superiority, ensuring an extreme detection range of up to 600 meters.

1.2 Main Function

- Distance Measurement: The device can detect the distance between the target and the device.
- Zeroing: The reticle helps you to aim at the target fast and accurately. See *Zeroing*.
- App Connection: The device can capture snapshots, record videos, and set parameters by HIKMICRO Sight App after being connected to your phone via hotspot.

1.3 Appearance

 **Note**

Pictures in this manual are for illustration purpose only. Please take the actual product for reference.

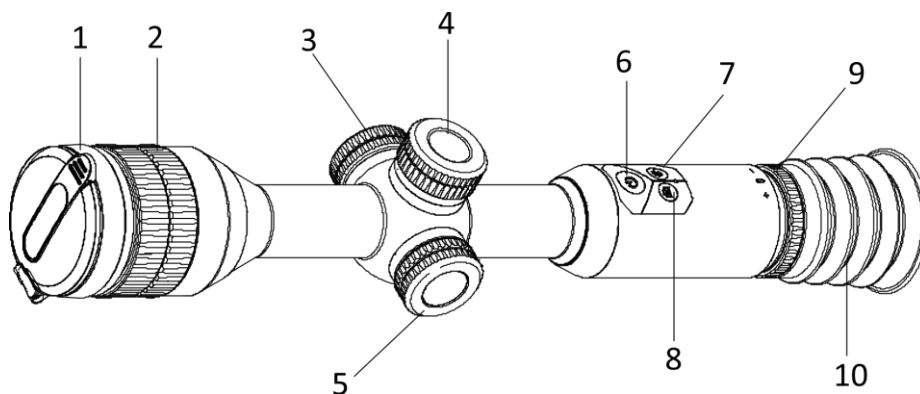

Figure 1-1 Buttons and Components

Digital Night Vision Scope User Manual

Table 1-1 Description of Buttons and Components

| No. | Component | Function |
|-----|-------------------------|---|
| 1 | Lens Cover | Protects the lens. |
| 2 | Focus Ring | Adjusts focus to obtain clear targets. |
| 3 | Type-C Interface | To connect the device to power supply or transmit data with a type-C cable. |
| 4 | Battery Compartment | For holding the battery. |
| 5 | Wheel | <ul style="list-style-type: none">● Hold: Enter/exit menu● Rotate: Switch digital zoom |
| 6 | Power Key | <ul style="list-style-type: none">● Press: Standby mode/wake up device● Hold: Power on/off |
| 7 | Switch Key | <ul style="list-style-type: none">● Press: Turn on/off PIP● Hold: Switch day/night mode |
| 8 | Capture Key | <ul style="list-style-type: none">● Press: Capture snapshots● Hold: Start/stop recording |
| 9 | Diopter Adjustment Ring | Adjusts the dioptric setting. |
| 10 | Eyepiece | The piece placed closest to the eye to view the target. |

 **Note**

Switch reticle: press Capture Key and Switch Key at the same time in the live view mode.

Chapter 2 Preparation

2.1 Cable Connection

Connect the device and power adaptor with a type-C cable to charge the device.

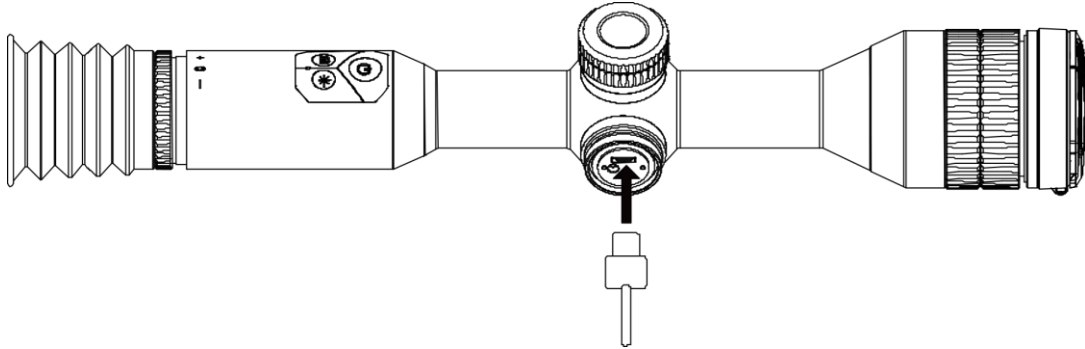

Figure 2-1 Cable Connection

 **Note**

Charge the device for more than 4 hours before first use.

2.2 Install Battery

2.2.1 Battery Instruction

- The external removable battery type is CR123A, and the battery size should be 16.5 mm × 34 mm. The max. rated voltage and capacity are 3 VDC and 1600 mAh.
- The built-in battery type is 18650 with the protection board, and the battery size should be 23 mm × 67 mm. The rated voltage and capacity are 3.6 VDC/3350 mAh (12.18 Wh).
- Install the external battery before the built-in battery runs out, or the device cannot be turned on.
- Do not charge the removable battery in the package.
- Remove the external battery if the device is not used for a long time.

2.2.2 Battery Installation

Insert the batteries into the battery compartment.

Steps

1. Turn the battery cover anticlockwise to loosen it.

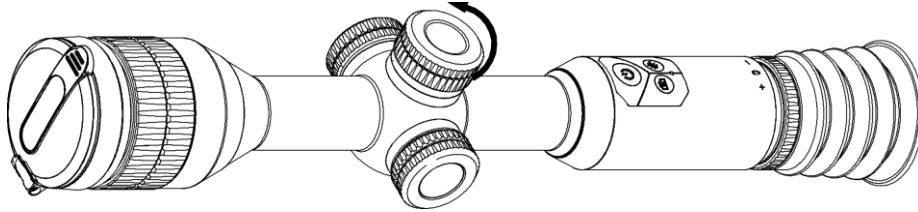

Figure 2-2 Loosen the Cover

2. Insert the battery into the battery compartment with the positive mark inward.

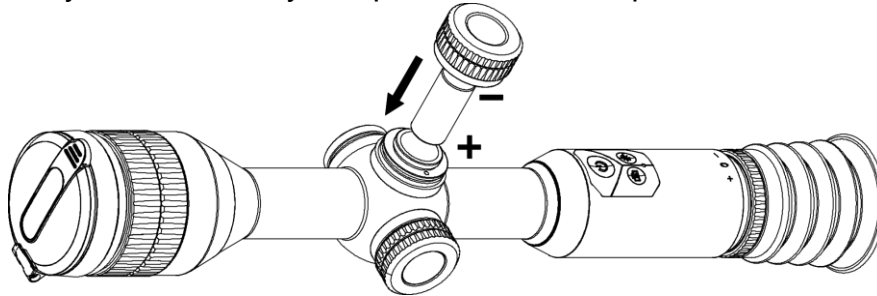

Figure 2-3 Install the Battery

3. Turn the battery cover clockwise to tighten it.

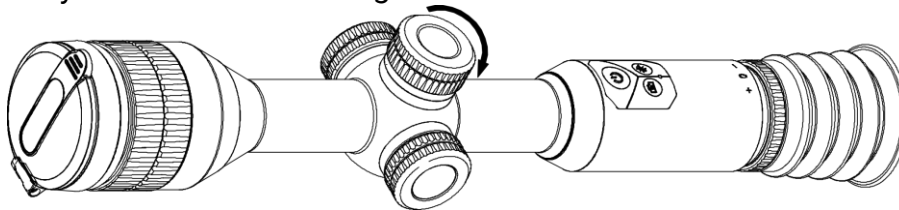

Figure 2-4 Tighten the Cover

2.3 Mount Device on Rail

Steps

1. Unscrew the ring top with Allen wrench.

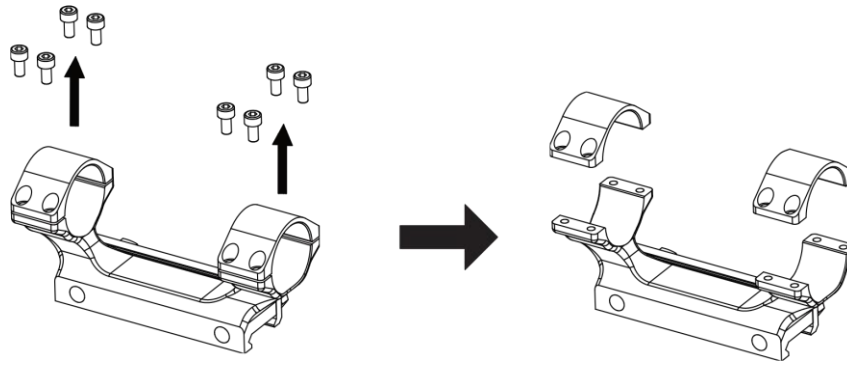

Figure 2-5 Remove the Ring Top

2. Place the device in the bottom half of the ring, and align the top holes with bottom holes.

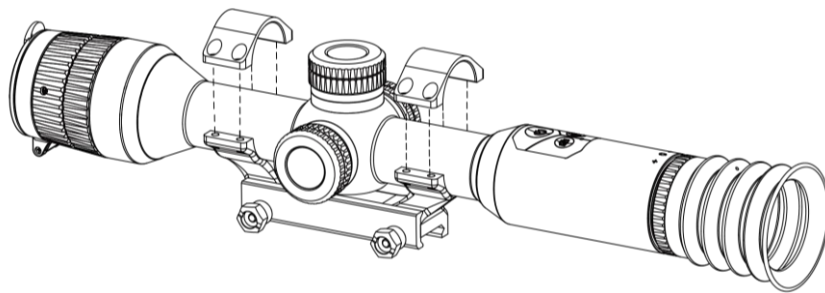

Figure 2-6 Put the Device to the Ring

3. Insert and tighten the screws.

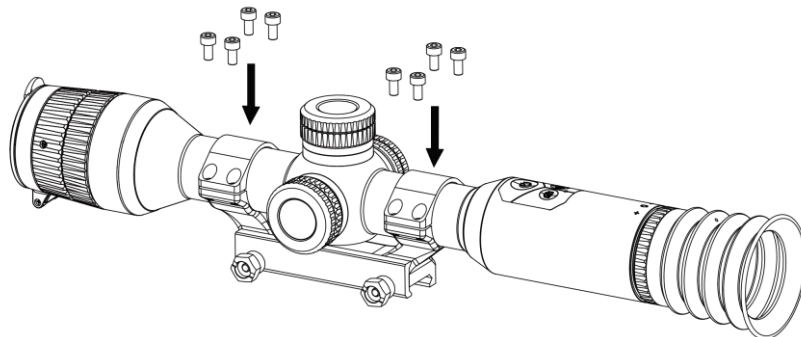

Figure 2-7 Tighten the Screws

4. Loosen the screws on the bottom half of the ring.

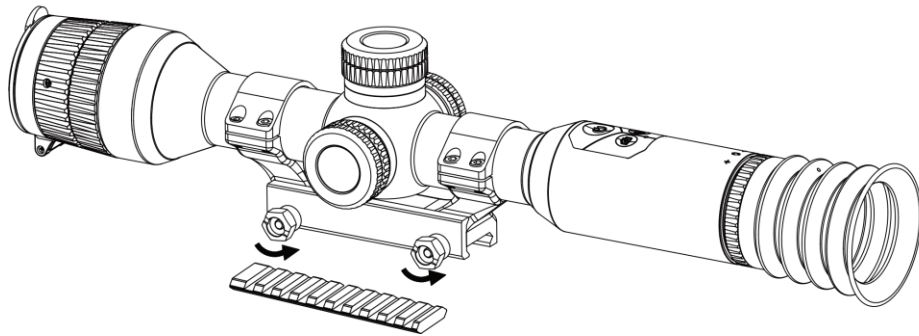

Figure 2-8 Loosen the Screws

5. Attach the bottom half of the ring to the rail, and tighten the screws on the ring. Make sure the device stays level.

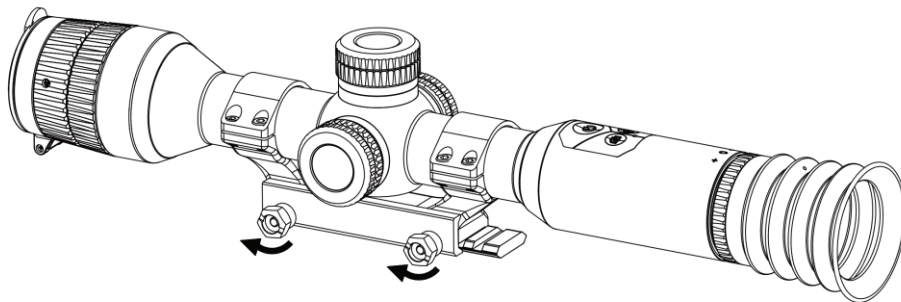

Figure 2-9 Tighten the Screws

Note

- The ring may vary according to different models. Please refer to the actual product.
 - The ring is not included in the package, please purchase it in advance.
-

2.4 Install IR Torch

Steps

1. Open the IR torch bracket, and put the device to IR torch bracket.

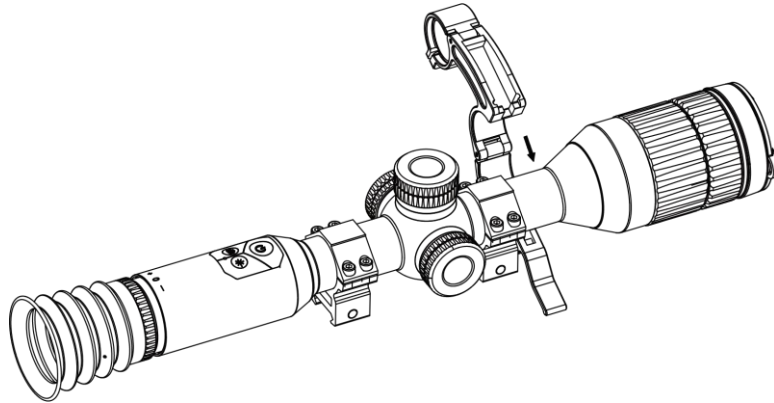

Figure 2-10 Open the IR Torch Bracket

2. Lock the lever by pressing it to fix the bracket as figure shows.

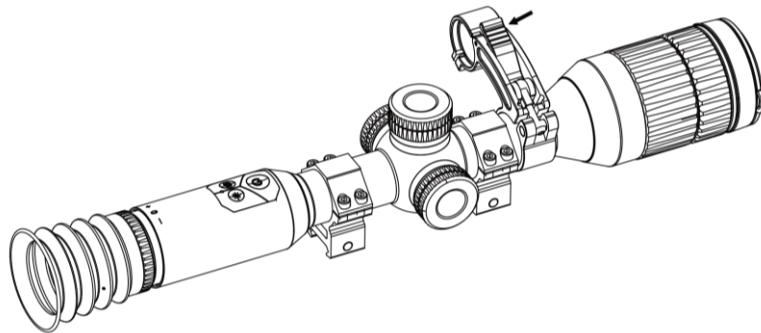

Figure 2-11 Lock the Lever

3. Turn the IR torch battery cover anticlockwise to remove it, and thread the IR torch through the bracket hoop, then turn the IR torch battery cover clockwise to tighten it.

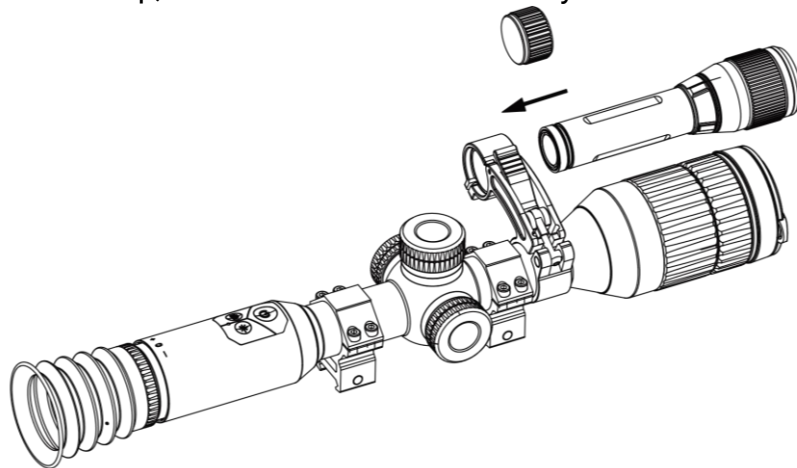

Figure 2-12 Thread the IR Torch

4. Tighten the screws to fix the IR torch.

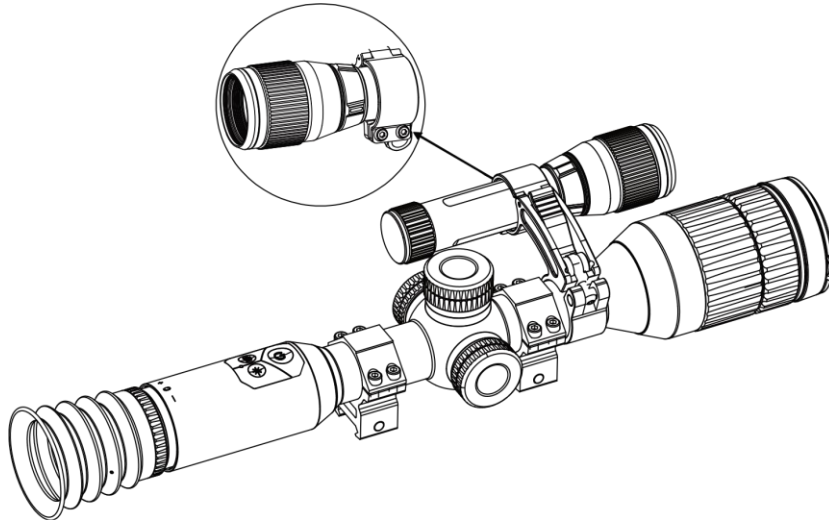

Figure 2-13 Fix the IR Torch

Note

- Rotate the lever to adjust the IR torch bracket. The lever would disassemble if continuously rotating it anticlockwise. Turn the lever clockwise to install it.
 - Please ensure the anti-slip pattern of the lever is outward when pressing the lever.
-

2.5 Power On/Off

Power On

When the battery is sufficiently charged, hold  to power on the device.

Power Off

When the device is turned on, hold  to power off the device.



Note

- Power-off countdown will appear when you hold . You can press any key to interrupt the countdown and cancel the power-off.
 - Automatic low battery power-off cannot be canceled.
-

Auto Power Off



You can set the auto power off time for your device.

Steps

1. In the menu, select  **General Settings**, and press the wheel to confirm.
 2. Rotate the wheel to select .
-

3. Press and rotate the wheel to the auto power-off time as required.
4. Hold the wheel to save and exit.

Note

- See the battery icon for the battery status.  means the battery is fully charged,  means that the battery is low, and  means the battery charging is abnormal.
 - When the low power note shows, charge the battery.
 - The auto power off takes effect only when the device enters the standby mode and the device isn't connected with HIKMICRO Sight app at the same time.
 - The auto power off countdown will start again when the device reenters standby mode, or the device is restarted.
-

2.6 Menu Description

When the device is turned on, hold the wheel to show the menu.

In the menu, you can rotate the wheel to select functions, press the wheel to configure the selected function, and hold the wheel to exit the menu.

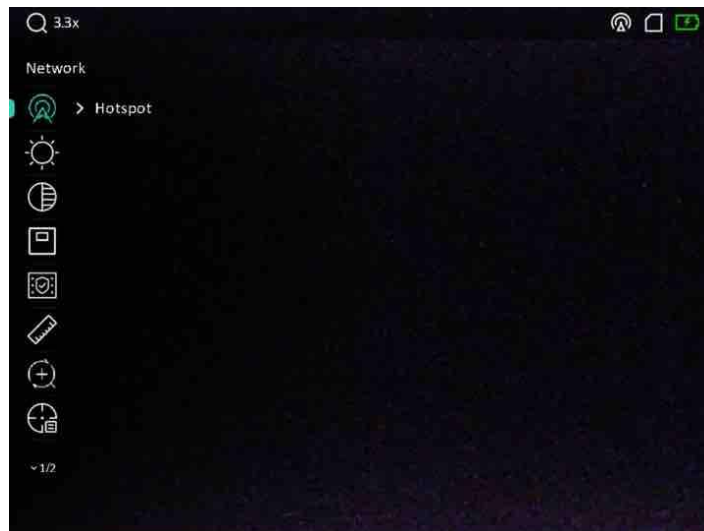

Figure 2-14 Menu Interface

2.7 App Connection

Connect the device to the HIKMICRO Sight App via hotspot, then you can capture picture,

record video, or configure parameters on your phone.

Steps

1. Search the HIKMICRO Sight on App Store (iOS System) or Google Play™ (Android System) to download it, or scan the QR code to download and install the app.



Android System



iOS System

2. In the menu, rotate the wheel to select .
3. Press and rotate the wheel to select **Hotspot**.
4. Turn on the WLAN of your phone and connect to the hotspot.
 - Hotspot Name: HIK-IPTS Serial No.
 - Hotspot Password: Serial No.
5. Open the app and connect your phone with the device. You can view the interface of device on your phone.

Note

- The device cannot connect to the app if you enter wrong password several times. Refer to **Restore Device** to reset the device, and connect the app again.
 - The device should be activated for the first use. The default password must be changed after the activation.
-

2.8 Firmware Status

2.8.1 Check Firmware Status

Steps

1. Open HIKMICRO Sight and connect your device to the app.
2. Check if there is an upgrade prompt on the device management interface. If there is no upgrade prompt, the firmware is the latest version. Otherwise, the firmware is not the latest version.

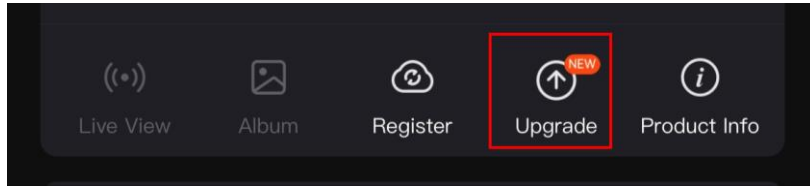

Figure 2-15 Check Firmware Status

3. (Optional) If the firmware is not the latest version, upgrade the device. See *Upgrade Device*.

2.8.2 Upgrade Device

Upgrade Device via HIKMICRO Sight

Before You Start

Install HIKMICRO Sight on your phone and connect your device to the app.

Steps

1. Tap the upgrade prompt to enter the firmware upgrade interface.
2. Tap **Upgrade** to start upgrade.

Note

The upgrading operation may vary due to app updates. Please take the actual app version for reference.

Upgrade Device via PC

Before You Start

- Please get the upgrade package first.
- Turn on the device after connecting it to your PC, and keep the device on for 10 to 15 seconds before other operations.

Steps

1. Connect the device to your PC with cable, and then turn on the device.
2. Open the detected disk, copy the upgrade file and paste it to the root directory of the device.
3. Hold  to reboot the device, and the device upgrades automatically. The upgrading process will be displayed in the main interface.

Note

During the upgrade package transmission, make sure the device is connected to your PC. Otherwise, it may cause unnecessary upgrade failure, firmware damage, etc.

2.9 Zeroing

You can enable the reticle to view the position of the target. The functions such as freeze and zoom help to adjust the reticle more accurately. See *Zeroing* for detailed instructions.

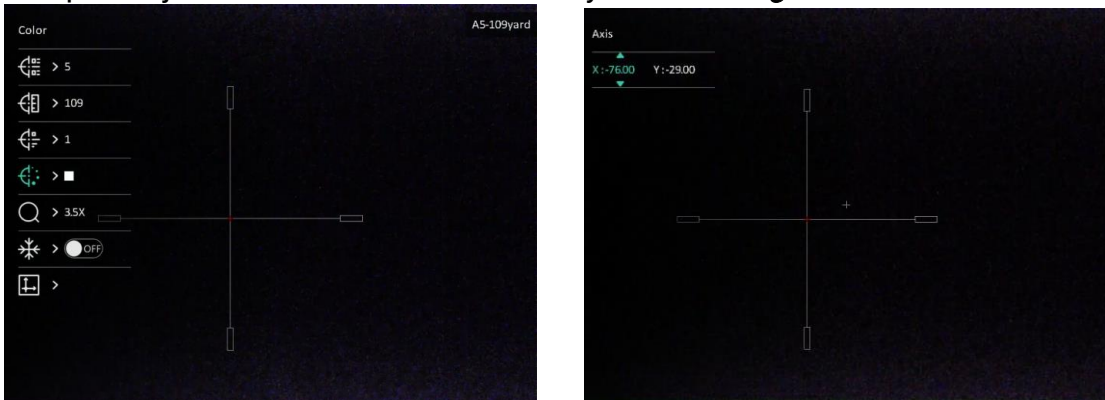

Figure 2-16 Zeroing

Chapter 3 Image Settings

3.1 Adjust Diopter

Steps

1. Power on the device.
2. Open the lens cover.
3. Hold the device and make sure the eyepiece covers your eye.
4. Adjust the diopter adjustment ring until the OSD text or image is clear.

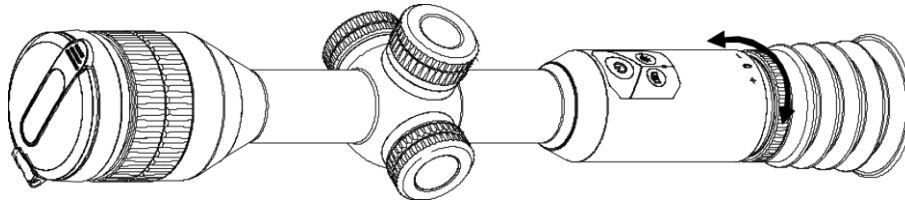

Figure 3-1 Adjust Diopter

Note

When adjusting diopter, DO NOT touch the surface of lens to avoid smearing the lens.

3.2 Adjust Focus

Steps

1. Power on the device.
2. Hold the device and make sure the eyepiece covers your eye.
3. Adjust the focus ring until the image is clear.

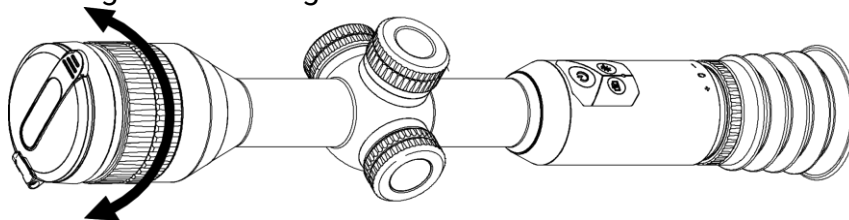



Figure 3-2 Adjust Focus

 **Note**

When focusing, do not touch the surface of lens to avoid smearing the lens.

3.3 Adjust Brightness

Steps

1. In the menu, select , and press the wheel to confirm.
2. Rotate the wheel to adjust brightness.
3. Hold the wheel to save and exit.

3.4 Adjust Contrast

Steps

1. In the menu, select , and press the wheel to confirm.
2. Rotate the wheel to adjust contrast.
3. Hold the wheel to save and exit.

3.5 Switch Day and Night

In live view mode, hold  to switch the day and night mode.



Day Mode



Night Mode

Figure 3-3 Day/Night Mode

3.6 Set Smart IR

Image overexposure may occur in too bright environment. The smart IR function helps to adjust the overexposed images by controlling infrared light intensity, so as to improve the image effect in night mode and dark environment.

In menu, select  and press the wheel to enable this function.

3.7 Set Picture in Picture Mode

Steps



1. In the menu, select .
2. Press the wheel to enable PIP function. The details show in the upper center of the view.
 - When reticle is enabled, the PIP view is the detail of reticle.
 - When reticle is not enabled, the PIP view is the detail of central part.



Figure 3-4 Picture in Picture Mode

3. Hold the wheel to exit.

Note

In the live view mode, press  to enable PIP quickly.

3.8 Adjust Digital Zoom

You can zoom in and out the image by using this function.

Steps

1. In the menu, select  , and press the wheel to confirm.
 2. Rotate the wheel to select a zoom mode.
 - **Multiple:** The digital zoom ratio can be set to 1×, 2×, and 4×.
 - **Continuous:** The digital zoom ratio can be set from 1.0× to 4.0× continuously.
 3. Hold the wheel to save and exit.
 4. In the live view interface, rotate the wheel to switch the digital zoom of the device.
-

Note

When switching the digital zoom ratio, the top-left corner of interface displays the actual magnification (Actual Magnification = Lens Optical Magnification × Digital Zoom Ratio). For example, the lens optical magnification is 2.8× and the digital zoom ratio is 2×, and the actual magnification is 5.6×.

Chapter 4 Zeroing

4.1 Select Zeroing Profile

If different users use the same device, the users can configure and save the reticle settings in their respective reticle group.

Steps

1. In the menu, select , and press the wheel to confirm.
- 2 Rotate the wheel to switch the zeroing profile.
3. Hold the wheel to save and exit.

Result

The right top of the image displays the reticle information. For example, A5-109 yard means you are using the No. 5 reticle in zeroing profile A, and the set distance is 109 yard.

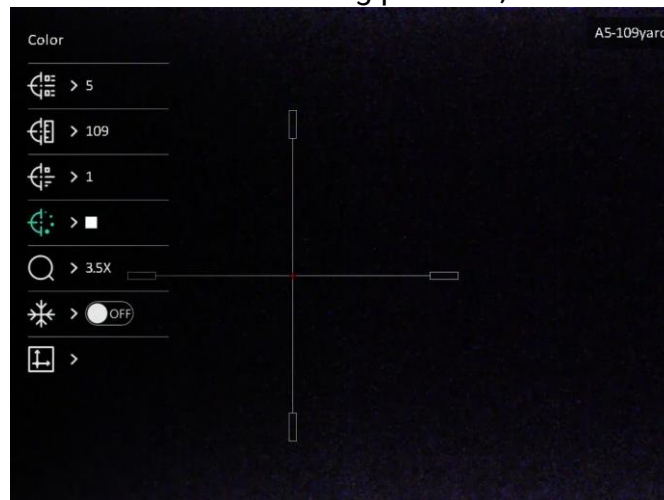



Figure 4-1 Using a Reticle

Note

- There are 5 zeroing profiles in total, and you can configure 5 reticles in each zeroing profile.
 - You can press  and  at the same time to switch the reticles in the selected zeroing profile in the live view interface.
-



4.2 Set Reticle Style

You can select color and type for your reticle in different environments.

Before You Start

Select a reticle No. you want to correct first.

Steps

1. In the zeroing interface, select  or  and press the wheel to confirm.
2. Rotate the wheel to switch reticle type and color.
3. Hold the wheel to exit the interface according to the prompt.
 - **OK:** Save the parameter and exit.
 - **Cancel:** Exit but not save the parameters.





4.3 Correct Reticle



Correcting the reticle can help you aim at the target with high accuracy by marking the offset between the big reticle and small reticle. Functions such as **Freeze** and **Zoom** help to adjust the reticle more accurately.

Before You Start

Select a zeroing profile first.

Steps

1. In the menu, select  and press the wheel to enter zeroing interface.
2. Select a reticle No. You can set 5 reticles.
 - a) Rotate the wheel to select , and press the wheel to confirm.
 - b) Rotate the wheel to select a reticle No. to correct.
 - c) Press the wheel again to confirm.
3. Set distance to the target.
 - a) Rotate the wheel to select , and press the wheel to switch the digit.
 - b) Rotate the wheel to change the number.
 - c) Press the wheel again to confirm.
4. Select , and press the wheel confirm. Rotate the wheel to enlarge the image until the target positions is clear enough.
5. Aim at the target and pull the trigger, and align the reticle with the point of impact.

- a) Aim the big reticle at the target.
- b) Rotate the wheel to select  , press the wheel to freeze the image.
- c) Select  and press the wheel to set the coordinates until the big reticle aligns with the point of impact. Press the wheel to select X or Y Axis. If you select X-axis, the reticle moves left and right; if you select Y-axis, the reticle moves up and down.

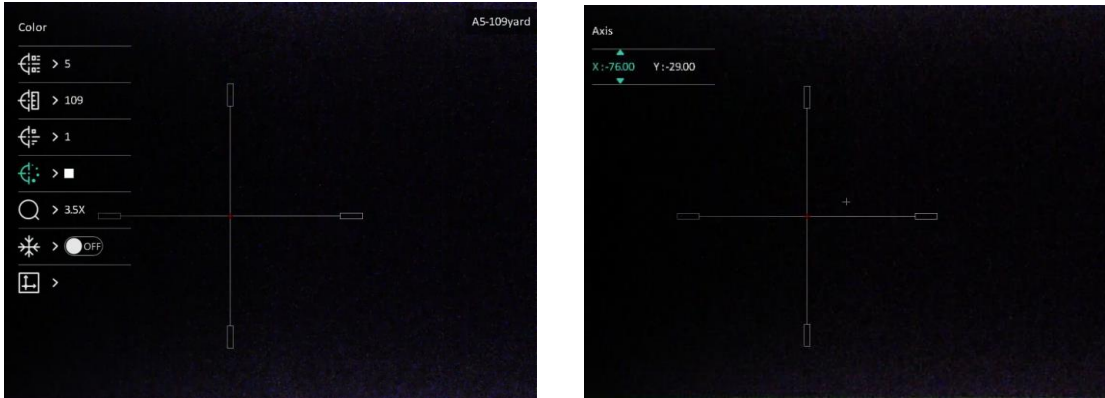

Figure 4-2 Correct Reticle

Note

- When you switch the reticle No., a prompt will appear on the interface. Select **OK** to save the parameters for the current reticle.
 - When enabling the freeze function in reticle, you can adjust the position of the cursor on a frozen image. This function can prevent image flutter.
-

6. Hold the wheel to exit the interface according to the prompt.
 - **OK**: Save the parameters and exit.
 - **CANCEL**: Exit but not save the parameters.
7. Pull the trigger again to verify that the aiming point aligns with the point of impact.
8. (Optional) Repeat 2 to 7 to set the position for other reticles in this zeroing profile.

Chapter 5 Measure Distance

The device can detect the distance between the target and the observation position.

Before You Start

When measuring the distance, keep the hand and the position steady. Otherwise, the accuracy may be affected.

Steps

1. In the menu, select , and press the wheel to go to the setting interface.
2. Set the parameters for the target.
 - 1) Rotate the wheel to select the target from **Deer, Grey Wolf, Brown Bear, and Custom.**
 - 2) Press and rotate the wheel to set target height.

Note

The available height ranges from 0.1 m to 9.0 m.

- 3) Press the wheel to confirm.
- 4) Hold the wheel to save the settings and return to the distance measurement interface.
3. Align the center of top mark with the edge of target top, and press the wheel to confirm.
4. Align the center of bottom mark with the edge of target bottom, and press the wheel to confirm.

Result

The right top of the image displays the distance measurement result and the height of the target.

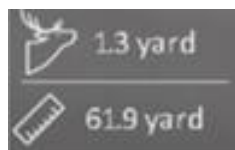



Figure 5-1 Measurement Result

Chapter 6 General Settings

6.1 Set OSD

You can choose whether to display the OSD information on the live view interface in this function.

Steps

1. In the menu, select  **Function Settings**, and press the wheel to enter the sub-menu.
2. Rotate the wheel to select , and press the wheel to enter the OSD setting interface.
3. Rotate the wheel to select the OSD information you want to display or not.
4. Press the wheel to enable the selected OSD information.



Note

If you turn off **OSD**, all OSD information on the live view will not be displayed.

6.2 Set Brand Logo

You can add brand logo on the live view interface.

Steps

1. In the menu, select  **Function Settings**, and press the wheel to enter the sub-menu.
2. Rotate the wheel to select , and press the wheel to enable **Brand Logo**.
3. Hold the wheel to save the settings and exit.

Result

The brand logo is displayed at the bottom left of the image.

6.3 Capture and Video

6.3.1 Capture Picture

In the view mode, press  to capture a picture.

Note

When capturing succeeds, the image freezes for 1 second and a prompt shows on the display.

For exporting captured pictures, refer to *Export Files*.

6.3.2 Set Audio

If you enable the audio function, the sound will be recorded with the video. When there is too loud noise in the video, you can disable this function.

Steps

1. In the menu, select .
2. Press the wheel to enable this function.
3. Hold the wheel to save and exit.

6.3.3 Record Video

Steps

1. In the live view interface, hold  and start recording.

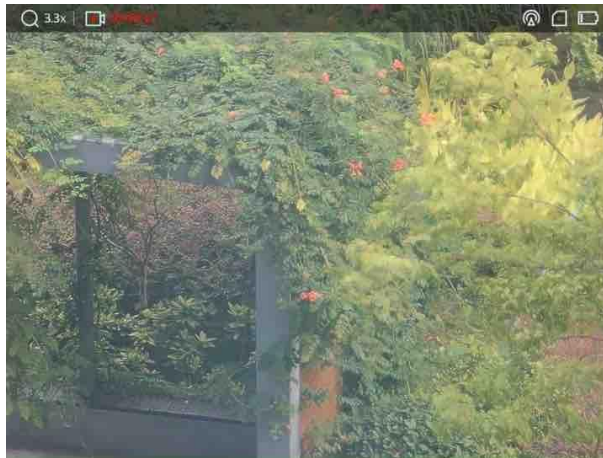

Figure 6-1 Start Recording

The left top of image displays the information of recording time.

2. Hold  again to stop recording.

What to do next

For exporting recording files, refer to *Export Files*.

6.3.4 Prerecord Video

After you enable this function and select the prerecording time, the device can automatically start recording the 7, 10 or 15 seconds before the recoil-activation and end recording the 7, 10 or 15 seconds after the recoil-activation.

Steps

1. In the menu, select , and press the wheel to confirm.
2. Rotate the wheel to switch the prerecording time. 7 s, 10 s, and 15 s are selectable.
3. Hold the wheel to save and exit.

Note

If the device recoils continuously, the device will record the 7, 10 or 15 seconds before the first recoil and end recording the 7, 10, or 15 seconds after the last recoil.

What to do next

For exporting recording files, refer to *Export Files*.

6.4 Export Files

This function is used to export recorded videos and captured pictures.

6.4.1 Export Files via HIKMICRO Sight

You can access device albums and export files to your phone via HIKMICRO Sight.

Before You Start

Install HIKMICRO Sight on your mobile phone.

Steps

1. Open HIKMICRO Sight and connect your device to the app. See *App Connection*.
2. Tap **Media** to access device albums.

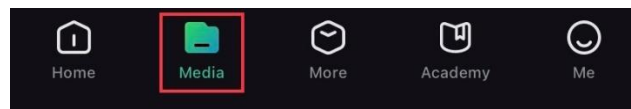

Figure 6-2 Access Device Album

3. Tap **Local** or **Device** to view the photos and videos.
 - **Local**: You can view the previous files on the app.

- **Device:** You can view the files of the current device.

Note

The photos or videos may not show in **Device**. Please pull down to refresh the page.

4. Tap to select a file, and tap **Download** to export the file to your local phone albums.



Figure 6-3 Download Files

Note

- Go to **Me > About > User Manual** on the app to see more detailed operations.
- You can also access device albums by tapping bottom left icon in the live view interface.

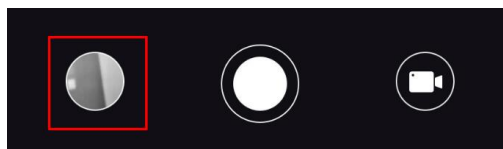

Figure 6-4 Access Device Albums

- The exporting operation may vary due to app updates. Please take the actual app version for reference.
-

6.4.2 Export Files via PC

Steps

1. Connect the device and PC with a Type-C cable.
-

Note

Make sure the device is turned on when connecting the cable.

2. Open computer disk and select the disk of device. Go to the **DCIM** folder and find the folder named after the capture year and month. For example, if you capture a picture or record a video in June 2022, go to **DCIM > 202206** to find the picture or video.
 3. Select and copy the files to PC.
 4. Disconnect the device from your PC.
-



 **Note**

- The device displays images when you connect it to PC, but functions such as recording, capturing and hotspot are disabled.
 - When you connect the device to PC for the first time, it installs the drive program automatically.
-

Chapter 7 System Settings



7.1 Adjust Date

Steps

1. In the menu, select  **General Settings**, and press the wheel to enter the sub-menu.
2. Select .
3. Press the wheel to select the year, month, or day, and rotate the wheel to change the number.
4. Hold the wheel to save settings and exit.

7.2 Synchronize Time



Steps

1. In the menu, select  **General Settings**, and press the wheel to enter the sub-menu.
2. Select .
3. Press and rotate the wheel to switch the clock system. 24-hour and 12-hour clock are selectable. If you select 12-hour clock, press and rotate the wheel to select AM or PM.
4. Press the wheel to select the hour or minute, and rotate the wheel to change the number.
5. Hold the wheel to save settings and exit.

7.3 Set Language

You can select the device language in this function.



Steps

1. In the menu, select  **General Settings**, and press the wheel to enter the sub-menu.
2. Select , and press the wheel to enter the language configuration interface.
3. Rotate the wheel to select the language as required, and press the wheel to confirm.
4. Hold the wheel to exit.



7.4 Set Unit

You can switch the unit for the distance measurement function and the reticle function.

Steps



1. In the menu, select  **General Settings**, and press the wheel to enter the sub-menu.
2. Select , and press the wheel to confirm.
3. Rotate the wheel to select **yard** or **m**.
4. Hold the wheel to save settings and exit.

7.5 View Device Information

1. In the menu, select  **General Settings**, and press the wheel to enter the sub-menu.
2. Select , and press the wheel. You can view the device information such as version and serial No.

7.6 Restore Device

Steps

1. In the menu, select  **General Settings**, and press the wheel to enter the sub-menu.
2. Select , and press the wheel to restore the device to defaults according to the prompt.

Chapter 8 Frequently Asked Questions

8.1 Why is the monitor off?

Check the following items.

- Check whether the device is off-battery.
- Check the monitor after charging the device for 5 minutes.

8.2 The image is not clear, how to adjust it?

Adjust the diopter adjustment ring or focus ring until the image is clear. Refer to *Adjust Diopter* or *Adjust Focus*.

8.3 Capturing or recording fails. What's the problem?

Check the following items.

- Whether the device is connected to your PC. Capturing or recording is disabled in this status.
- Whether the storage space is full.
- Whether the device is low-battery.

8.4 Why the PC cannot identify the device?

Check the following items.

- Whether the device is connected to your PC with supplied USB cable.
- If you use other USB cables, make sure the cable length is no longer than 1 m.

Safety Instruction



These instructions are intended to ensure that user can use the product correctly to avoid danger or property loss.

Laws and Regulations

- Use of the product must be in strict compliance with the local electrical safety regulations.

Symbol Conventions

The symbols that may be found in this document are defined as follows.

| Symbol | Description |
|--|---|
|  Danger | Indicates a hazardous situation which, if not avoided, will or could result in death or serious injury. |
|  Caution | Indicates a potentially hazardous situation which, if not avoided, could result in equipment damage, data loss, performance degradation, or unexpected results. |
|  Note | Provides additional information to emphasize or supplement important points of the main text. |

Transportation

- Keep the device in original or similar packaging while transporting it.
- Keep all wrappers after unpacking them for future use. In case of any failure occurred, you need to return the device to the factory with the original wrapper. Transportation without the original wrapper may result in damage on the device and the company shall not take any responsibilities.
- DO NOT drop the product or subject it to physical shock. Keep the device away from magnetic interference.

Power Supply

- Please purchase the charger by yourself. Input voltage should meet the Limited Power Source (5 VDC, 2A) according to the IEC61010-1 standard. Please refer to technical specifications for detailed information.
- Make sure the plug is properly connected to the power socket.
- DO NOT connect multiple devices to one power adapter, to avoid over-heating or fire hazards caused by overload.
- The power source should meet limited power source or PS2 requirements according to

IEC 62368-1 standard.

- Use the power adapter provided by qualified manufacturer. Refer to the product specification for detailed power requirements.

Battery

- Improper use or replacement of the battery may result in explosion hazard. Replace with the same or equivalent type only.
- The built-in battery type is 18650 with the protection board, and the battery size should be 23 mm × 67 mm. The rated voltage and capacity are 3.6 VDC/3350 mAh (12.18 Wh).
- The external removable battery type is CR123A, and the max. rated voltage and capacity are 3 VDC and 1600 mAh. Dispose of used batteries in conformance with the instructions provided by the battery manufacturer.
- Use the battery provided by qualified manufacturer. Refer to the product specification for detailed battery requirements.
- Make sure the battery temperature is between 0 °C to 45 °C (32 °F to 113 °F) when charging.
- Install the external battery before the built-in battery runs out, or the device cannot be turned on.
- Confirm there is no flammable material within 2 m of the charger during charging.
- DO NOT place the battery near heating or fire source. Avoid direct sunlight.
- DO NOT place the battery in the reach of children.

Maintenance

- If the product does not work properly, please contact your dealer or the nearest service center. We shall not assume any responsibility for problems caused by unauthorized repair or maintenance.
- Wipe the device gently with a clean cloth and a small quantity of ethanol, if necessary.
- If the equipment is used in a manner not specified by the manufacturer, the protection provided by the device may be impaired.
- It is recommended to reboot the device every 2 hours when using it to ensure the device performance.

Using Environment

- Make sure the running environment meets the requirement of the device. The operating temperature shall be between -30 °C to 55 °C (-22 °F to 131 °F), and the relative humidity shall be 5% to 95%.
- DO NOT expose the device to high electromagnetic radiation or dusty environments.
- DO NOT aim the lens at the sun or any other bright light.
- Place the device in a dry and well-ventilated environment.
- When any laser equipment is in use, make sure that the device lens is not exposed to the laser beam, or it may burn out.

Emergency

If smoke, odor, or noise arises from the device, immediately turn off the power, unplug the power cable, and contact the service center.

Manufacture Address

Room 313, Unit B, Building 2, 399 Danfeng Road, Xixing Subdistrict, Binjiang District,
Hangzhou, Zhejiang 310052, China
Hangzhou Microimage Software Co., Ltd.

Legal Information

©2023 Hangzhou Microimage Software Co., Ltd. All rights reserved.

About this Manual

The Manual includes instructions for using and managing the Product. Pictures, charts, images and all other information hereinafter are for description and explanation only. The information contained in the Manual is subject to change, without notice, due to firmware updates or other reasons. Please find the latest version of this Manual at the HIKMICRO website (www.hikmicrotech.com/).

Please use this Manual with the guidance and assistance of professionals trained in supporting the Product.

Trademarks Acknowledgement



and other HIKMICRO's trademarks and logos are the properties of HIKMICRO in various jurisdictions.

Other trademarks and logos mentioned are the properties of their respective owners.

LEGAL DISCLAIMER

TO THE MAXIMUM EXTENT PERMITTED BY APPLICABLE LAW, THIS MANUAL AND THE PRODUCT DESCRIBED, WITH ITS HARDWARE, SOFTWARE AND FIRMWARE, ARE PROVIDED "AS IS" AND "WITH ALL FAULTS AND ERRORS". HIKMICRO MAKES NO WARRANTIES, EXPRESS OR IMPLIED, INCLUDING WITHOUT LIMITATION, MERCHANTABILITY, SATISFACTORY QUALITY, OR FITNESS FOR A PARTICULAR PURPOSE. THE USE OF THE PRODUCT BY YOU IS AT YOUR OWN RISK. IN NO EVENT WILL HIKMICRO BE LIABLE TO YOU FOR ANY SPECIAL, CONSEQUENTIAL, INCIDENTAL, OR INDIRECT DAMAGES, INCLUDING, AMONG OTHERS, DAMAGES FOR LOSS OF BUSINESS PROFITS, BUSINESS INTERRUPTION, OR LOSS OF DATA, CORRUPTION OF SYSTEMS, OR LOSS OF DOCUMENTATION, WHETHER BASED ON BREACH OF CONTRACT, TORT (INCLUDING NEGLIGENCE), PRODUCT LIABILITY, OR OTHERWISE, IN CONNECTION WITH THE USE OF THE PRODUCT, EVEN IF HIKMICRO HAS BEEN ADVISED OF THE POSSIBILITY OF SUCH DAMAGES OR LOSS.

YOU ACKNOWLEDGE THAT THE NATURE OF THE INTERNET PROVIDES FOR INHERENT SECURITY RISKS, AND HIKMICRO SHALL NOT TAKE ANY RESPONSIBILITIES FOR ABNORMAL OPERATION, PRIVACY LEAKAGE OR OTHER DAMAGES RESULTING FROM CYBER-ATTACK, HACKER ATTACK, VIRUS INFECTION, OR OTHER INTERNET SECURITY RISKS; HOWEVER, HIKMICRO WILL PROVIDE TIMELY TECHNICAL SUPPORT IF REQUIRED. YOU AGREE TO USE THIS PRODUCT IN COMPLIANCE WITH ALL APPLICABLE LAWS, AND YOU ARE SOLELY RESPONSIBLE FOR ENSURING THAT YOUR USE CONFORMS TO THE APPLICABLE LAW. ESPECIALLY, YOU ARE RESPONSIBLE, FOR USING THIS PRODUCT IN A MANNER THAT DOES NOT INFRINGE ON THE RIGHTS OF THIRD PARTIES, INCLUDING

WITHOUT LIMITATION, RIGHTS OF PUBLICITY, INTELLECTUAL PROPERTY RIGHTS, OR DATA PROTECTION AND OTHER PRIVACY RIGHTS. YOU SHALL NOT USE THIS PRODUCT FOR ILLEGAL HUNTING ANIMALS, INVASION OF PRIVACY OR ANY OTHER PURPOSE WHICH IS ILLEGAL OR DETRIMENTAL TO THE PUBLIC INTEREST. YOU SHALL NOT USE THIS PRODUCT FOR ANY PROHIBITED END-USES, INCLUDING THE DEVELOPMENT OR PRODUCTION OF WEAPONS OF MASS DESTRUCTION, THE DEVELOPMENT OR PRODUCTION OF CHEMICAL OR BIOLOGICAL WEAPONS, ANY ACTIVITIES IN THE CONTEXT RELATED TO ANY NUCLEAR EXPLOSIVE OR UNSAFE NUCLEAR FUEL-CYCLE, OR IN SUPPORT OF HUMAN RIGHTS ABUSES.

PLEASE FOLLOW ALL THE PROHIBITIONS AND EXCEPTIONAL CAVEATS OF ALL APPLICABLE LAWS AND REGULATIONS, IN PARTICULAR, THE LOCAL FIREARMS AND/OR HUNTING LAWS AND REGULATIONS. PLEASE ALWAYS CHECK NATIONAL PROVISIONS AND REGULATIONS BEFORE PURCHASE OR USE OF THIS PRODUCT. PLEASE NOTE THAT YOU MAY HAVE TO APPLY FOR PERMITS, CERTIFICATES, AND/OR LICENSES BEFORE ANY PURCHASING, SELLING, MARKETING AND/OR USING OF THE PRODUCT. HIKMICRO SHALL NOT BE LIABLE FOR ANY SUCH ILLEGAL OR IMPROPER PURCHASING, SELLING, MARKETING, AND END USES AND ANY SPECIAL, CONSEQUENTIAL, INCIDENTAL, OR INDIRECT DAMAGES ARISING THEREOF.

IN THE EVENT OF ANY CONFLICTS BETWEEN THIS MANUAL AND THE APPLICABLE LAW, THE LATTER PREVAILS.

Regulatory Information

These clauses apply only to the products bearing the corresponding mark or information.

FCC Information

Please take attention that changes or modification not expressly approved by the party responsible for compliance could void the user's authority to operate the equipment. FCC compliance: This equipment has been tested and found to comply with the limits for a Class B digital device, pursuant to part 15 of the FCC Rules. These limits are designed to provide reasonable protection against harmful interference in a residential installation. This equipment generates, uses and can radiate radio frequency energy and, if not installed and used in accordance with the instructions, may cause harmful interference to radio communications. However, there is no guarantee that interference will not occur in a particular installation. If this equipment does cause harmful interference to radio or television reception, which can be determined by turning the equipment off and on, the user is encouraged to try to correct the interference by one or more of the following measures:

- Reorient or relocate the receiving antenna.
- Increase the separation between the equipment and receiver.
- Connect the equipment into an outlet on a circuit different from that to which the receiver is connected.
- Consult the dealer or an experienced radio/TV technician for help.

FCC Conditions

This device complies with part 15 of the FCC Rules. Operation is subject to the following two conditions:

1. This device may not cause harmful interference.
2. This device must accept any interference received, including interference that may cause undesired operation.

This equipment complies with FCC radiation exposure limits set forth for an uncontrolled environment.

EU Compliance Statement



This product and - if applicable - the supplied accessories too are marked with "CE" and comply therefore with the applicable harmonized European standards listed under the Directive 2014/30/EU (EMCD), Directive 2014/35/EU (LVD), Directive 2011/65/EU (RoHS), Directive 2014/53/EU.

Hereby, Hangzhou Microimage Software Co., Ltd. declares that this device (refer to the label) is in compliance with Directive 2014/53/EU. The full text of the EU declaration of conformity is available at the following internet address:

<https://www.hikmicrotech.com/en/support/download-center/declaration-of-conformity/>

Frequency Bands and Power (for CE)

The frequency bands and transmitting power (radiated and/or conducted) nominal limits applicable to the following radio equipment are as follows:

Wi-Fi 2.4 GHz (2.4 GHz to 2.4835 GHz), 20 dBm



Directive 2012/19/EU (WEEE Directive): Products marked with this symbol cannot be disposed of as unsorted municipal waste in the European Union. For proper recycling, return this product to your local supplier upon the purchase of equivalent new equipment, or dispose of it at designated collection points. For more information see:

www.recyclethis.info



Directive 2006/66/EC and its amendment 2013/56/EU (Battery Directive): This product contains a battery that cannot be disposed of as unsorted municipal waste in the European Union. See the product documentation for specific battery information. The battery is marked with this symbol, which may include lettering to indicate cadmium (Cd), lead (Pb), or mercury (Hg). For proper recycling, return the battery to your supplier or to a designated collection point. For more information see: www.recyclethis.info.

Industry Canada ICES-003 Compliance

This device meets the CAN ICES-003 (B)/NMB-003(B) standards requirements.

This device complies with Industry Canada license-exempt RSS standard(s). Operation is subject to the following two conditions:

- (1) this device may not cause interference, and
- (2) this device must accept any interference, including interference that may cause undesired operation of the device.

This equipment complies with IC RSS-102 radiation exposure limits set forth for an uncontrolled environment.

Conformité Industrie Canada ICES-003

Cet appareil répond aux exigences des normes CAN ICES-003 (B)/NMB-003 (B).

Cet appareil est conforme aux normes RSS exemptes de licence d'Industrie Canada. Son

fonctionnement est soumis aux deux conditions suivantes :

- (1) cet appareil ne doit pas causer d'interférences, et
- (2) cet appareil doit accepter toute interférence reçue, notamment les interférences susceptibles d'occasionner un fonctionnement indésirable de l'appareil.

Cet appareil est conforme aux limites d'exposition au rayonnement IC RSS-102 établies pour un environnement non contrôlé.

INFORMATIONEN FÜR PRIVATE HAUSHALTE

1. Getrennte Erfassung von Altgeräten:

Elektro- und Elektronikgeräte, die zu Abfall geworden sind, werden als Altgeräte bezeichnet. Besitzer von Altgeräten haben diese einer vom unsortierten Siedlungsabfall getrennten Erfassung zuzuführen. Altgeräte gehören insbesondere nicht in den Hausmüll, sondern in spezielle Sammel- und Rückgabesysteme.

2. Batterien und Akkus sowie Lampen:

Besitzer von Altgeräten haben Altbatterien und Altakkumulatoren, die nicht vom Altgerät umschlossen sind, die zerstörungsfrei aus dem Altgerät entnommen werden können, im Regelfall vor der Abgabe an einer Erfassungsstelle vom Altgerät zu trennen. Dies gilt nicht, soweit Altgeräte einer Vorbereitung zur Wiederverwendung unter Beteiligung eines öffentlich-rechtlichen Entsorgungsträgers zugeführt werden.

3. Möglichkeiten der Rückgabe von Altgeräten:

Besitzer von Altgeräten aus privaten Haushalten können diese bei den Sammelstellen der öffentlich-rechtlichen Entsorgungsträger oder bei den von Herstellern oder Vertreibern im Sinne des ElektroG eingerichteten Rücknahmestellen unentgeltlich abgeben.

Rücknahmepflichtig sind Geschäfte mit einer Verkaufsfläche von mindestens 400 m² für Elektro- und Elektronikgeräte sowie diejenigen Lebensmittelgeschäfte mit einer Gesamtverkaufsfläche von mindestens 800 m², die mehrmals pro Jahr oder dauerhaft Elektro- und Elektronikgeräte anbieten und auf dem Markt bereitstellen. Dies gilt auch bei Vertrieb unter Verwendung von Fernkommunikationsmitteln, wenn die Lager- und Versandflächen für Elektro- und Elektronikgeräte mindestens 400 m² betragen oder die gesamten Lager- und Versandflächen mindestens 800 m² betragen. Vertreter haben die Rücknahme grundsätzlich durch geeignete Rückgabemöglichkeiten in zumutbarer Entfernung zum jeweiligen Endnutzer zu gewährleisten. Die Möglichkeit der unentgeltlichen Rückgabe eines Altgerätes besteht bei rücknahmepflichtigen Vertreibern unter anderem dann, wenn ein neues gleichartiges Gerät, das im Wesentlichen die gleichen Funktionen erfüllt, an einen Endnutzer abgegeben wird.

4. Datenschutz-Hinweis:

Altgeräte enthalten häufig sensible personenbezogene Daten. Dies gilt insbesondere für Geräte der Informations- und Telekommunikationstechnik wie Computer und Smartphones. Bitte beachten Sie in Ihrem eigenen Interesse, dass für die Löschung der Daten auf den zu entsorgenden Altgeräten jeder Endnutzer selbst verantwortlich ist.

5. Bedeutung des Symbols „durchgestrichene Mülltonne“:



Das auf Elektro- und Elektronikgeräten regelmäßig abgebildete Symbol einer durchgestrichenen Mülltonne weist darauf hin, dass das jeweilige Gerät am Ende seiner Lebensdauer getrennt vom unsortierten Siedlungsabfall zu erfassen ist.



HIKMICRO

See the World in a New Way



Facebook: HIKMICRO Outdoor Instagram: hikmicro_outdoor

YouTube: HIKMICRO Outdoor

LinkedIn: HIKMICRO

Website: www.hikmicrotech.com

E-mail: support@hikmicrotech.com

UD35775B