



Handheld Thermography Camera

HIKMICRO SP Series

User Manual

Safety Instruction

These instructions are intended to ensure that user can use the product correctly to avoid danger or property loss.

Laws and Regulations

- Use of the product must be in strict compliance with the local electrical safety regulations.

Transportation

- Keep the device in original or similar packaging while transporting it.
- Keep all wrappers after unpacking them for future use. In case of any failure occurred, you need to return the device to the factory with the original wrapper.
- Transportation without the original wrapper may result in damage on the device and the company shall not take any responsibilities.
- Do not drop the product or subject it to physical shock. Keep the device away from magnetic interference.

Power Supply

- The input voltage should meet the Limited Power Source (7.2 VDC, 890 mA) according to the IEC61010-1 standard. Please refer to technical specifications for detailed information.
- Make sure the plug is properly connected to the power socket.
- DO NOT connect multiple devices to one power adapter, to avoid overheating or fire hazards caused by overload.

Battery

- This device is not suitable for use in locations where children are likely to be present.
- CAUTION: Risk of explosion if the battery is replaced by an incorrect type. Replace with the same or equivalent type only. Dispose of used batteries in conformance with the instructions provided by the battery manufacturer.
- Improper replacement of the battery with an incorrect type may defeat a safeguard (for example, in the case of some lithium battery types).
- Do not dispose of the battery into fire or a hot oven, or mechanically crush or cut the battery, which may result in an explosion.

- Do not leave the battery in an extremely high temperature surrounding environment, which may result in an explosion or the leakage of flammable liquid or gas.
- Do not subject the battery to extremely low air pressure, which may result in an explosion or the leakage of flammable liquid or gas.
- Dispose of used batteries according to the instructions.
- DO NOT charge other battery types with the supplied charger. Confirm there is no flammable material within 2 m of the charger during charging.
- When the device is powered off and the RTC battery is full, the time settings can be kept for 6 months.
- In the first use, power on the device and charge the RTC battery with the lithium battery for more than 4 hours.
- The battery voltage is 7.2 V, and the battery capacity is 4800 mAh.
- Use the battery provided by a qualified manufacturer. Refer to the product specification for detailed battery requirements.
- The battery is certified by UL2054.

Maintenance

- DO NOT maintain the camera when it is powered on, or it may cause electric shock! If the product does not work properly, please contact your dealer or the nearest service center. We shall not assume any responsibility for problems caused by unauthorized repair or maintenance.
- A few device components (e.g., electrolytic capacitor) require regular replacement. The average lifespan varies, so periodic checking is recommended. Contact your dealer for details.
- Wipe the device gently with a clean cloth and a small quantity of ethanol, if necessary.
- Clean the lens with cotton wool and 99% ethyl alcohol.
- If the equipment is used in a manner not specified by the manufacturer, the protection provided by the device may be impaired.
- Please notice that the current limit of USB 3.0 PowerShare port may vary with the PC brand, which is likely to result in incompatibility issue. Therefore it's advised to use regular USB 3.0 or USB 2.0 port if the USB device fails to be recognized by PC via USB 3.0 PowerShare port.
- Your camera will periodically perform a self-calibration to optimize image quality and measurement accuracy. In this process the image will pause briefly and you'll hear a "click" as a shutter moves in front of the detector. The self-calibration will be more frequent during start up or in very cold or hot environments. This is a normal part of operation to

ensure optimum performance for your camera.

Using Environment

- DO NOT expose the device to extremely hot, cold, dusty, corrosive, saline-alkali, or damp environments. Make sure the running environment meets the requirement of the device. The operating temperature shall be -20 °C to 50 °C (-4 °F to 122 °F), and the operating humidity shall be 95% or less.
- Place the device in a dry and well-ventilated environment.
- DO NOT expose the device to high electromagnetic radiation or dusty environments.
- DO NOT aim the lens at the sun or any other bright light.
- When any laser equipment is in use, make sure that the device lens is not exposed to the laser beam, or it may burn out.
- The device is suitable for indoor and outdoor uses, but do not expose it in wet conditions.
- The level of protection is IP 54.
- The pollution degree is 2.

Calibration Service

Please contact the local dealer for the information on maintenance points. For more detailed calibration services, please visit <https://www.hikmicrotech.com/en/support/>.

Technical Support

- The <https://www.hikmicrotech.com/en/contact-us.html> portal will help you as a HIKMICRO customer to get the most out of your HIKMICRO products. The portal gives you access to our support team, software and documentation, service contacts, etc.

Emergency

- If smoke, odor, or noise arises from the device, immediately turn off the power, unplug the power cable, and contact the service center.

White Supplement Light

- The beam of the light at the distance of 200 mm is classified as Risk Group 1 (RG1).
- Wear appropriate eye protection or DO NOT turn on the white light when you assemble, install or maintain the camera.
- If appropriate shielding or eye protection is not available, turn on the light only at a safe distance (1.3 m) or in the area that is not directly

exposed to the light when installing or maintaining the device.

Laser



- Complies with 21 CFR 1040.10 and 1040.11 except for conformance with IEC 60825-1 Ed.3., as described in Laser Notice No. 56, dated May 8, 2019.
- Warning: The laser radiation emitted from the device can cause eye injuries, burning of skin or inflammable substances. Prevent eyes from direct laser and wear a pair of goggles for your safety. The operating wavelength of the eyewear should be longer than laser peak wavelength and its optical density should be higher than OD5+. The wave length is 650 nm, laser beam divergence angle is less than $1^\circ \times 0.6^\circ$. The pulse duration is 0.7 ns, and the Max. average power is 8 mW. The laser meets the IEC 60825-1:2014, EN60825-1:2014+A11:2021 standard, and EN 50689: 2021 standard.
- Instantaneous exposure to this class 2 laser product is safe, but gazing at this laser product may cause dizziness, flash blindness and visual afterimage. Move your head away or close your eyes to avoid the laser radiation.
- Before enabling the Light Supplement function, make sure no human or inflammable substances are in front of the laser lens.
- Laser maintenance: It is not necessary to maintain the laser regularly. If the laser does not work, the laser assembly needs to be replaced in the factory under warranty. Keep the device power off when replacing laser assembly.
- Caution-Use of controls or adjustments or performance of procedures other than those specified herein may result in hazardous radiation exposure.

Limited Warranty

Scan the QR code for the product warranty policy.



Manufacture Address



Room 313, Unit B, Building 2, 399 Danfeng Road, Xixing Subdistrict,
Binjiang District, Hangzhou, Zhejiang 310052, China

Hangzhou Microimage Software Co., Ltd.

COMPLIANCE NOTICE: The thermal series products might be subject to export controls in various countries or regions, including without limitation, the United States, European Union, United Kingdom and/or other member countries of the Wassenaar Arrangement. Please consult your professional legal or compliance expert or local government authorities for any necessary export license requirements if you intend to transfer, export, re-export the thermal series products between different countries.

Symbol Conventions

The symbols that may be found in this document are defined as follows.

Symbol	Description
 Danger	Indicates a hazardous situation which, if not avoided, will or could result in death or serious injury.
 Caution	Indicates a potentially hazardous situation which, if not avoided, could result in equipment damage, data loss, performance degradation, or unexpected results.
 Note	Provides additional information to emphasize or supplement important points of the main text.

Contents

1	Overview.....	1
1.1	Device Description.....	1
1.2	Main Function.....	1
1.3	Appearance.....	2
2	Preparation.....	8
2.1	Cable Connection.....	8
2.2	Charge Battery.....	8
2.2.1	Remove Battery.....	8
2.2.2	Charge Battery via Charging Base.....	10
2.3	Change Interchangeable Lens.....	11
2.4	Detector Cleaning.....	13
2.5	Mount Hand Strap.....	13
2.6	Mount Neck Strap.....	15
2.7	Tilt Lens and Screen.....	15
2.8	Power On/Off.....	16
2.9	Sleep and Wake.....	16
2.10	Operation Method.....	17
2.11	Menu Description.....	18
2.11.1	Live View Interface.....	18
2.11.2	Main Menu.....	21
2.11.3	Swipe-Down Menu.....	21
3	Display Settings.....	23
3.1	Focus.....	23
3.1.1	Focus Lens.....	23
3.1.2	Laser Assisted Focus.....	24
3.1.3	Auto Focus.....	24
3.1.4	Continuous Autofocus.....	25
3.1.5	High Temperature Priority.....	26
3.2	Set Screen Brightness.....	26
3.3	Set Display Mode.....	26
3.4	Set Palettes.....	27
3.4.1	Set Alarm Mode Palettes.....	28
3.4.2	Set Focus Mode Palettes.....	30
3.5	Adjust Level & Span.....	30
3.6	Set Color Distribution.....	32
3.7	Adjust Digital Zoom.....	33
3.8	Set Auto-Rotation.....	34
3.9	Display OSD Info.....	34
4	Temperature Measurement.....	35

Handheld Thermography Camera User Manual

4.1	Set Measurement Parameters.....	35
4.2	Set Image Measurement.....	36
4.3	Set Measurement Tool.....	37
4.3.1	Measure by Custom Spot.....	38
4.3.2	Measure by Line.....	39
4.3.3	Measure by Rectangle.....	40
4.3.4	Measure by Circle.....	42
4.4	Measure ΔT and ΔT Alarm.....	43
4.5	Temperature Alarm.....	44
4.5.1	Set Alarms for Exceptional Temperatures.....	44
4.6	Calculate Area Size.....	45
4.7	Clear All Measurements.....	46
5	Condensation Alarm.....	47
6	Route Inspection.....	48
6.1	Create Inspection Route and Send Task to Device.....	48
6.2	Perform Route Inspection.....	49
6.3	Upload Inspection Result and View Report.....	51
7	Picture and Video.....	54
7.1	Capture Picture.....	54
7.2	Record Video.....	58
7.3	Filename Header and File Naming.....	60
7.4	View and Manage Local Files.....	60
7.4.1	Manage Albums.....	61
7.4.2	Manage Files.....	62
7.4.3	Edit Images.....	63
7.4.4	Import and Manage Tag Note Templates.....	65
7.5	Export Files.....	66
7.5.1	Export Files to PC.....	66
7.5.2	Export Files to HIKMICRO Viewer.....	66
7.5.3	Export Files via Bluetooth.....	67
8	Distance Detection.....	69
9	Geographic Location Display.....	70
10	Direction Display.....	71
10.1	Calibrate Compass.....	71
10.2	Magnetic Declination Correction.....	72
11	Add Device to Software Clients.....	73
11.1	Connect Device to HIKMICRO Viewer via Wi-Fi.....	73
11.2	Connect Device to HIKMICRO Viewer via Hotspot.....	74
11.3	Connect Device to HIKMICRO Inspector.....	75
11.4	Cast Screen on HIKMICRO Analyzer.....	76
12	System Settings.....	77

Handheld Thermography Camera User Manual

12.1	Set LED Light	77
12.2	Set Unit.....	77
12.3	HDMI Image Output.....	77
12.4	Set Time and Date	77
13	Maintenance.....	78
13.1	View Device Information	78
13.2	Upgrade Device.....	78
13.2.1	Upgrade Device via PC.....	78
13.2.2	Upgrade Device via HIKMICRO Viewer	79
13.3	Restore Device.....	79
13.4	Initialize Memory Card	79
13.5	Save Logs.....	79
13.6	About Calibration.....	80
14	Appendix.....	81
14.1	FAQ.....	81

1 Overview

1.1 Device Description

The handheld thermography camera is a device with both optical images and thermal images. It can do thermography, distance measurement, video recording, snapshot capturing, alarm, and it can connect to Wi-Fi, hotspot and Bluetooth. The built-in high-sensitivity IR detector and high-performance sensor detect the variation of temperature and measure the real-time temperature. Refer to the production specification on HIKMICRO website for detailed information. The built-in laser module detects the target distance.

The device is easy to use, and adopts ergonomic design. It is widely applied to substations, electricity prevention detection of companies, and reconnaissance survey of construction field.

1.2 Main Function

Table 1-1 Main Function of the Device

Function	Description
Temperature Measurement	Device detects the real-time temperature, and display it on the screen.
Route Inspection	Device can check the temperature of the check points in a predefined inspection route, and upload the results to center client for analysis.
Distance Measurement	Device can detect the target distance with the laser light.
Fusion	Device can display fusion of thermal view and optical view.
Palette and Alarm	Device supports multiple palettes, and you can set the palette mode according to the alarm function.
Geographical Location and Direction Display	For some models that are equipped satellite positioning module and compass, geographical location and direction display are supported.

	The function is supported by certain models of this series.
HDMI Output	For some models that have a micro HDMI output interface, you can connect the device to a display unit to view live image.
Client Software Connection	Mobile Phone: Use HIKMICRO Viewer to see live image, capture, and recording, etc. on your phone. PC: Use HIKMICRO Analyzer to see live image, capture, recording, receive alarm message and analyze files exported from the device and etc. on your PC. Use HIKMICRO Inspector to create inspection routes, send route inspection tasks to devices, collect inspection results.
Bluetooth	Device can be connected to headset via Bluetooth, and you can hear the voice in the recording or capture.

1.3 Appearance

I

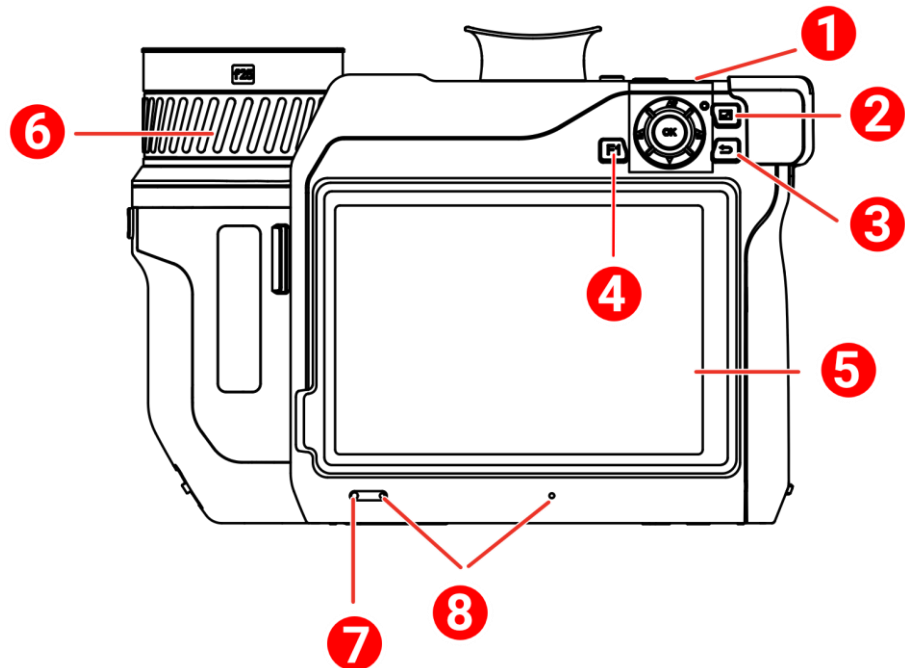

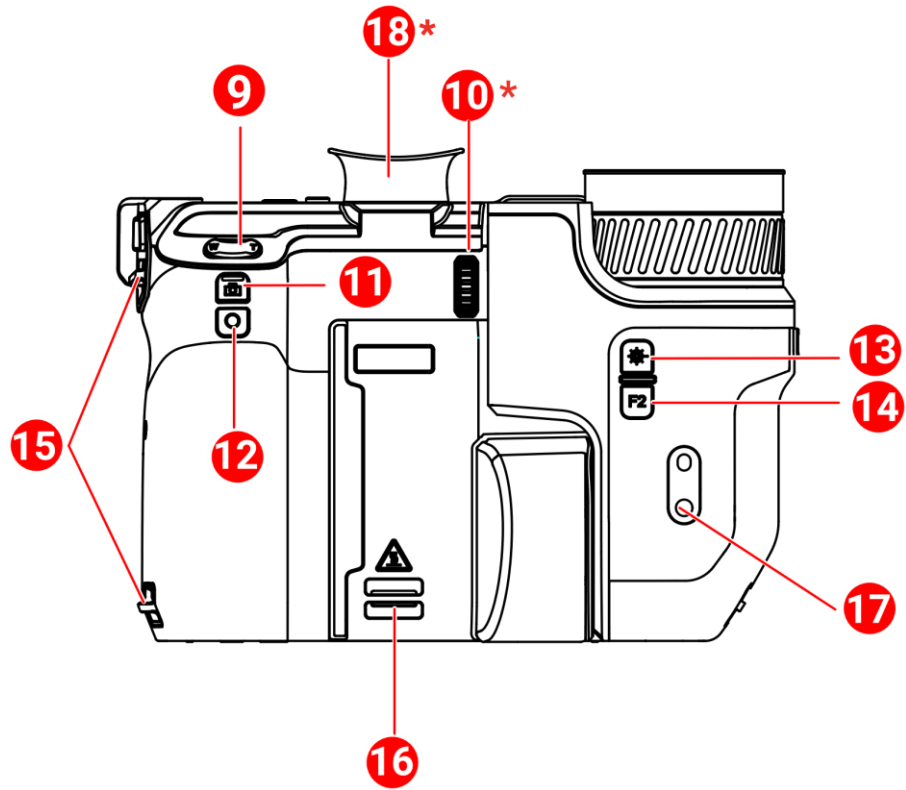

II

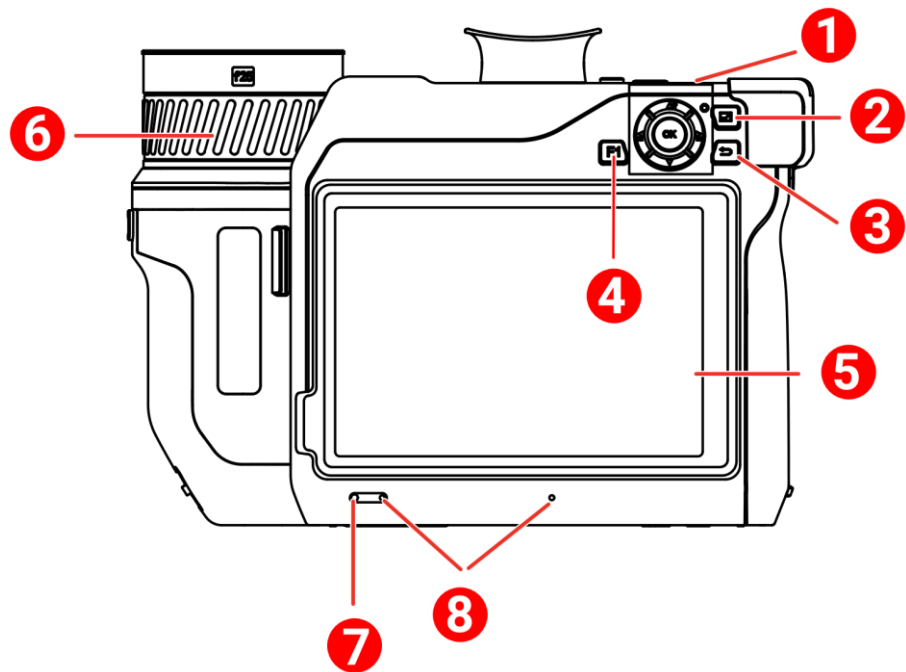

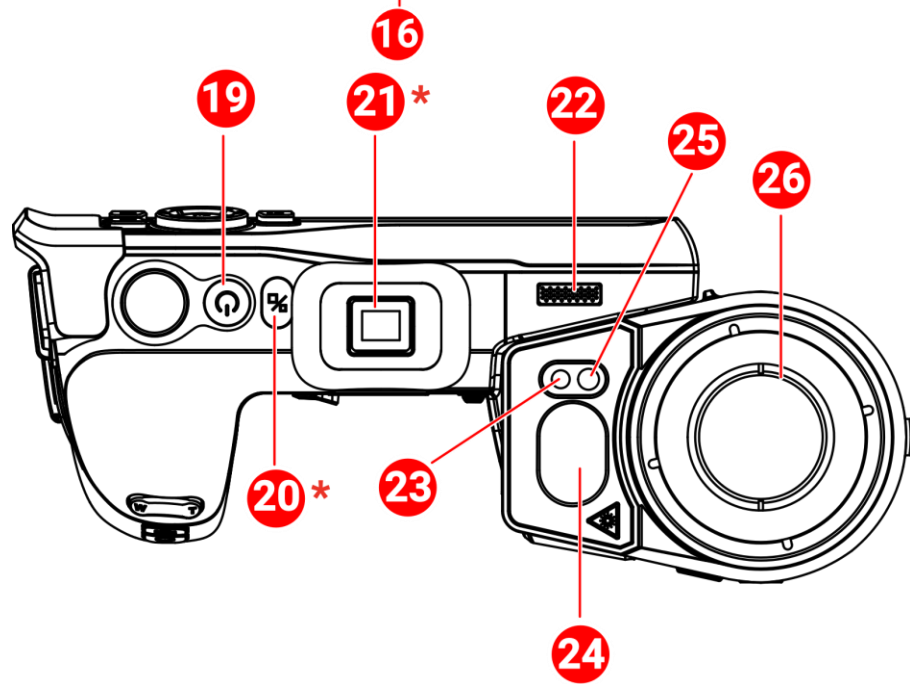
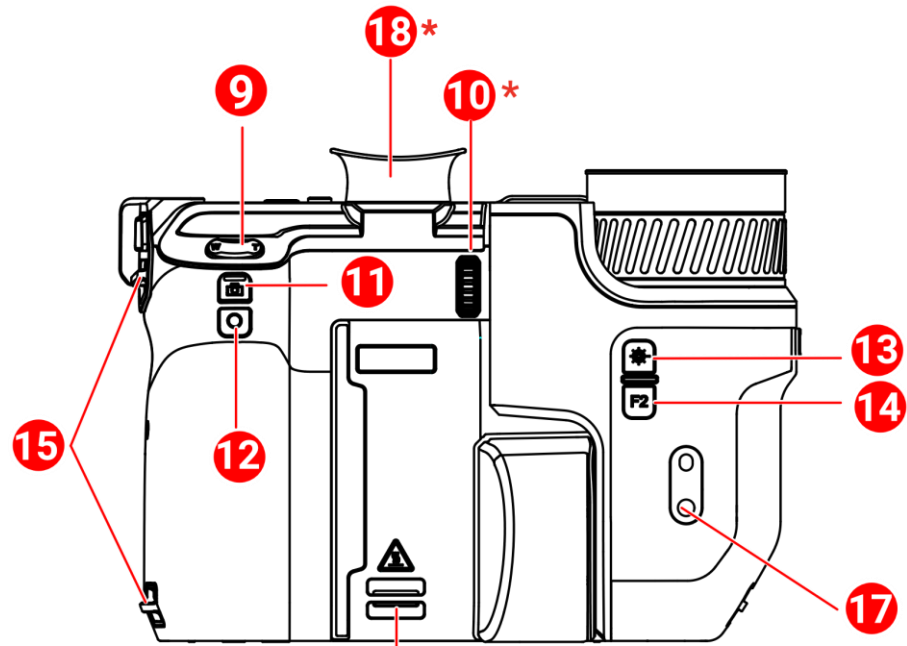

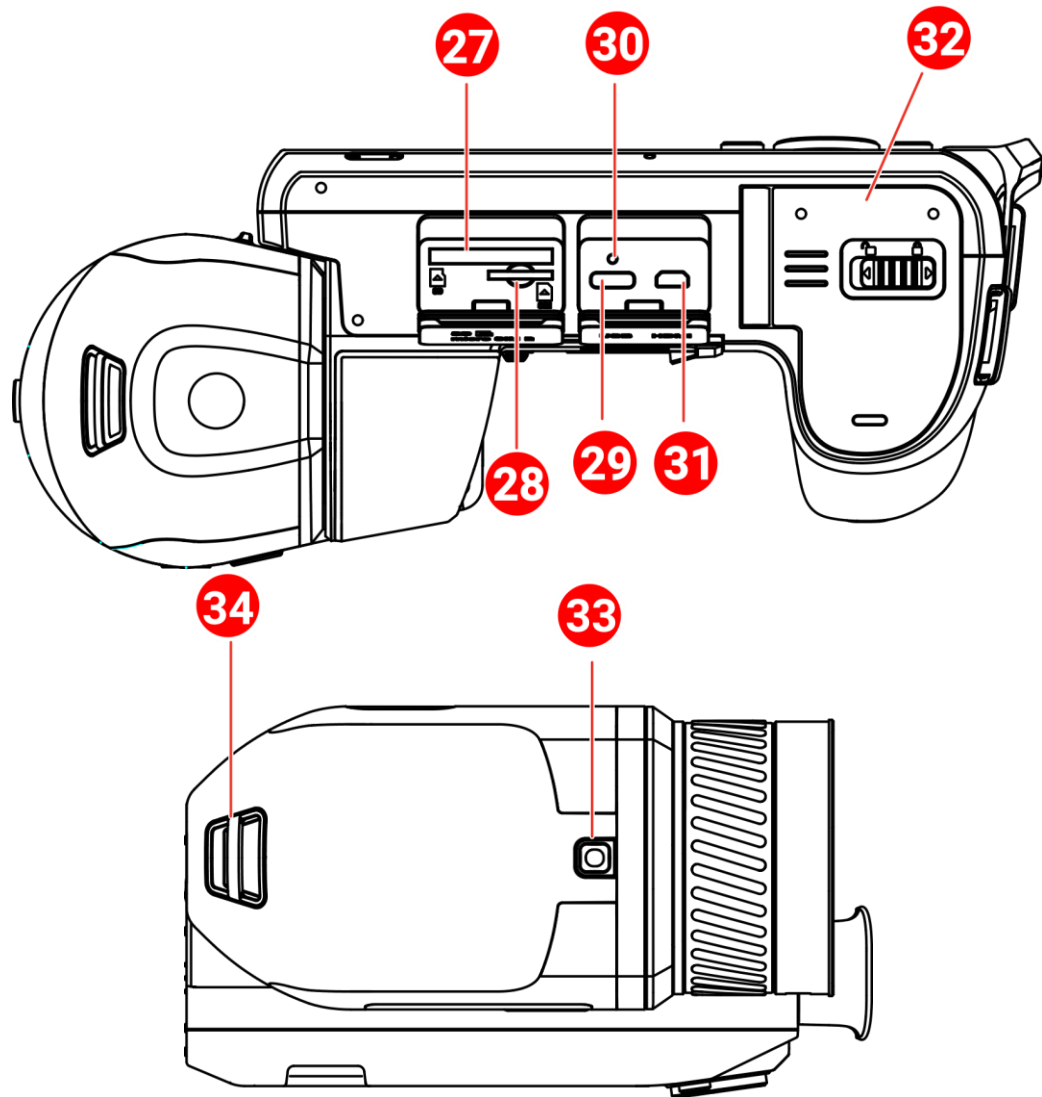

Figure 1-1 Buttons and Interfaces

Table 1-2 Button and Interface Description

No.	Description	Function
1	Navigation Button	<p>Menu Mode:</p> <ul style="list-style-type: none"> ● Press , , , and to select parameters. ● Press OK to confirm. <p>Non-Menu Mode:</p> <ul style="list-style-type: none"> ● Press to turn on/off the LED light supplement. ● Press and to adjust focus.
2	File Button	Press to enter albums.
3	Back Button	Exit the menu or return to previous menu.

Handheld Thermography Camera User Manual

No.	Description	Function
4 & 14	Programmable Buttons	Press F1/F2 button to use the custom function.
5	Touch Screen	<ul style="list-style-type: none"> ● Show the live view interface. ● Touch-screen operation.
6	Focus Ring	Adjust focus to find clear targets.
7	Light Sensor	Sense the ambient brightness.
8	Microphone	To add voice note.
9	Zoom Button	Press \mathbb{T} to zoom in, and press \mathbb{W} to zoom out.
10	Diopter Adjustment Wheel	Adjust the dioptic correction for the viewfinder.
11	Capture Button	<ul style="list-style-type: none"> ● Press: capture snapshots/stop recording ● Hold: start recording
12	Focus Button	Press to start focus.
13	Laser Button	<ul style="list-style-type: none"> ● Press: measure the distance with laser once ● Hold: measure the distance with laser continuously
15	Hand Strap Attachment Point	Mount the hand strap.
16 & 34	Neck Strap Attachment Point	Mount the neck strap.
17	Tripod Mount	Mount the tripod.
18	Viewfinder	View live view through the viewfinder. See Display Switch Button.
19	Power Button	<ul style="list-style-type: none"> ● Press: standby mode/wake up device ● Hold: power on/off
20	Display Switch Button	Switch the LCD and the Viewfinder.
21	Eyepiece Plug	Protect the eyepiece.
22	Loudspeaker	Play voice note and voice alarm.
23	Optical Lens	View the optical image.
24	Laser Distance Meter and Laser Output	Measure the distance with laser.
25	Supplement Light	Increase ambient brightness in dark environment.
26	Thermal Lens	View the thermal image.
27	Memory Card Slot	Insert the memory card in it.

Handheld Thermography Camera User Manual

No.	Description	Function
28	SIM Card Slot	Not Available.
29	Data Exchange Interface	Charge the device or export files with supplied cable.
30	Indicator	Indicate the charging status of the device. <ul style="list-style-type: none">● Solid red: charging normally● Flashing red: charging exception● Solid green: fully charged
31	Micro HDMI Interface	Connect the device with HDMI cable. A cable converter (HDMI Type D to HDMI Type A) is included in the carrying case.
32	Battery Compartment	Install the battery in it.
33	Lens Release Button	Unlock the interchangeable lens.



The laser radiation emitted from the device can cause eye injuries, burning of skin or inflammable substances. Before enabling the light supplement function, make sure no human or inflammable substances are in front of the laser lens.

2 Preparation

2.1 Cable Connection

Connect the device and power adaptor with a Type-C cable to charge the device battery. Alternatively, connect the device and PC to export files.

1. Lift the cable interface cover.
2. Connect the device and the Type-C cable.

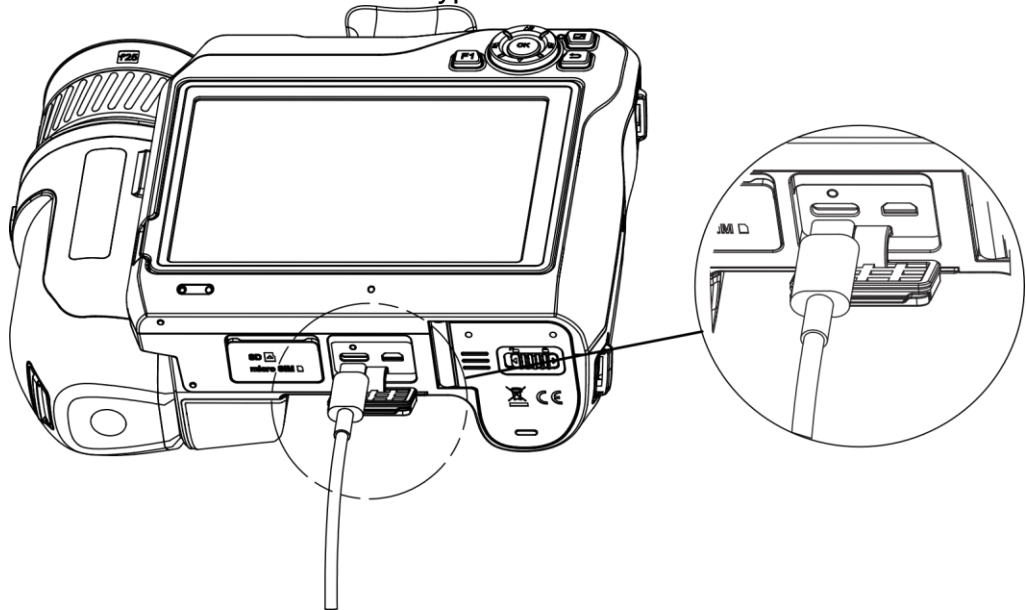

Figure 2-1 Connect to Type-C Cable



The power delivered by the charger must be between min 38 Watts required by the radio equipment, and max 50 Watts in order to achieve the maximum charging speed. USB PD fast charging is supported.

2.2 Charge Battery

2.2.1 Remove Battery

Before You Start

Turn off the device before you remove the battery.

1. Push the battery compartment lock leftwards to unlock the battery compartment, and then open the battery cover.

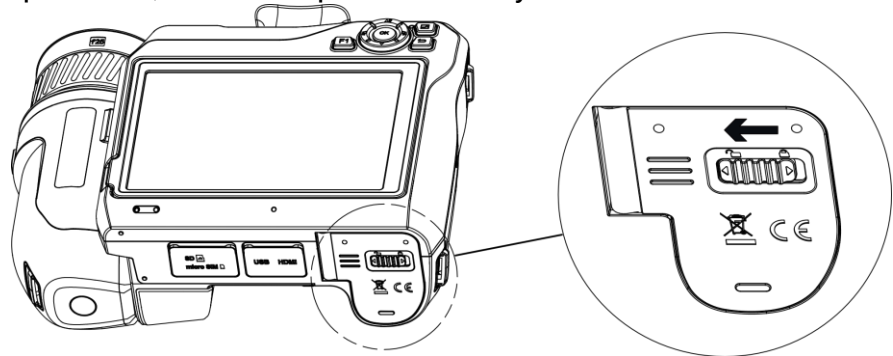

Figure 2-2 Unlock Battery Compartment

2. Push the inner battery lock (in the black circle) leftwards to release the battery.

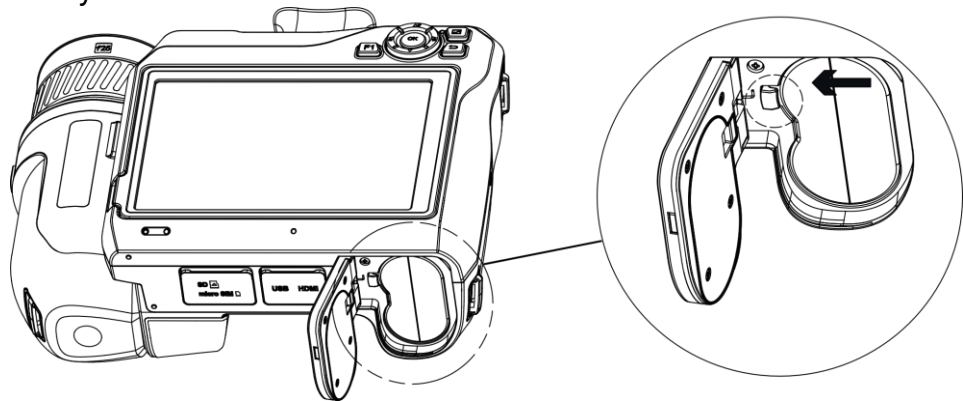

Figure 2-3 Release Battery

3. Take the battery out of the battery compartment.

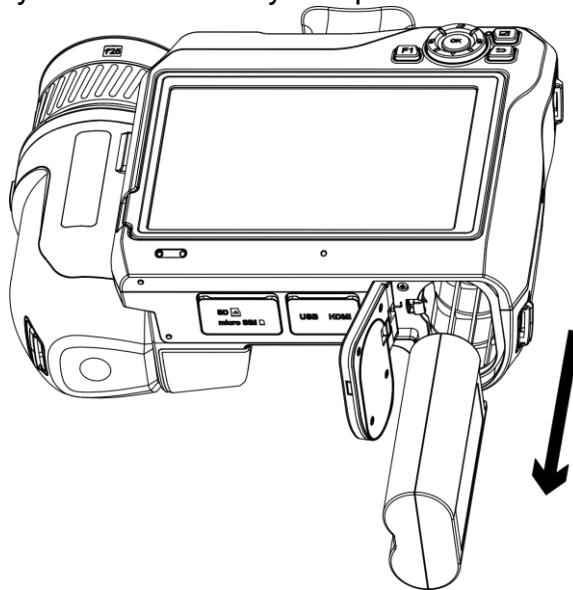

Figure 2-4 Remove Battery

2.2.2 Charge Battery via Charging Base



Please charge the battery with the cable and power adapter supplied by the manufacturer (or according to the input voltage from the specifications).

1. Put one or two batteries in the charging base.
2. Connect the supplied charging base to the power supply. The indicator in the middle is green if it works properly.
3. The left and right indicators show the charging status of the batteries.
 - Solid red: charging normally.
 - Solid green: fully charged.
4. Draw the battery from the charging base, and disconnect charging base from the power supply.

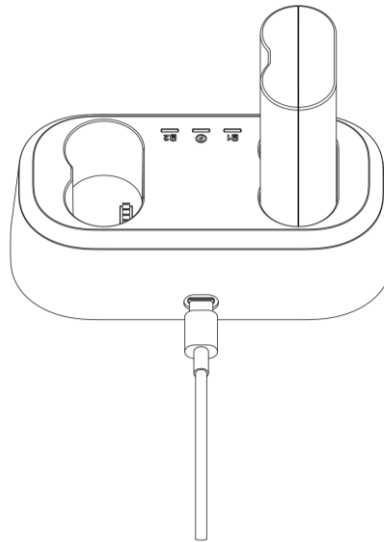

Figure 2-5 Charge Battery via Charging Base



In the first use, charge the device for more than 4 hours in the power-off status.

2.3 Change Interchangeable Lens

An interchangeable lens is a thermal lens that can be mounted to the device for obtaining different FOVs, scene scopes, and temperature measurement ranges.

Before You Start

- Purchase a suitable interchange lens recommended by the device manufacturer.
- The device pops up a window to show the lens information or the calibration program when detecting a mounted lens.

1. Press the lens release button and turn the interchangeable lens anticlockwise until it stops.

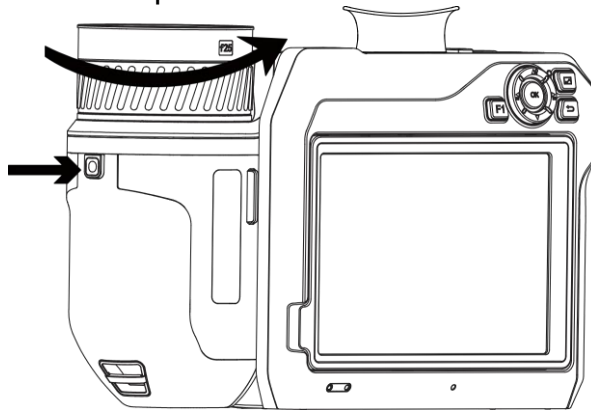

Figure 2-6 Release Lens

2. Remove the interchangeable lens carefully.

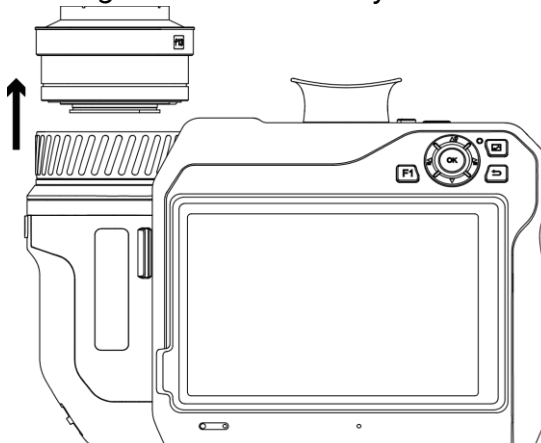

Figure 2-7 Remove Lens

3. Align the two white index marks on the device and the lens.

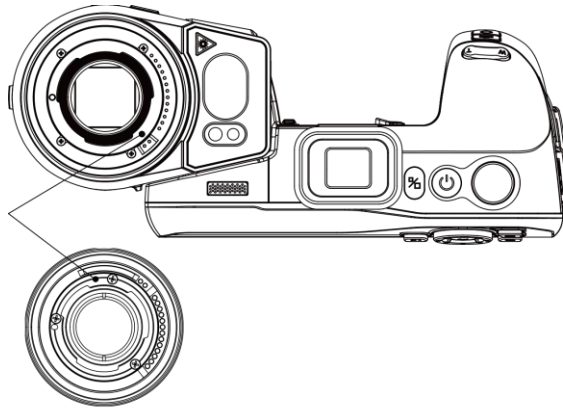

Figure 2-8 Align White Marks

4. Push the lens into position.

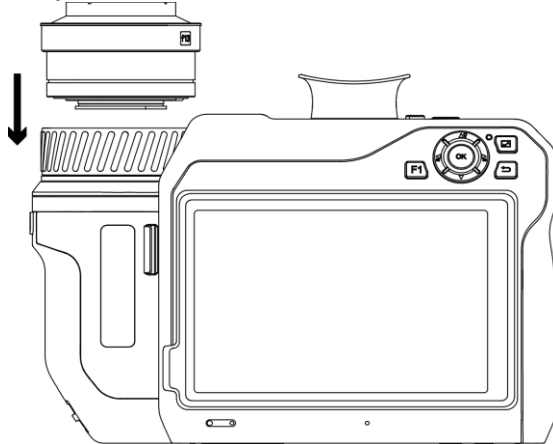

Figure 2-9 Mount Lens

5. Rotate the lens clockwise to fix it. The lens makes a click when it locks in place.

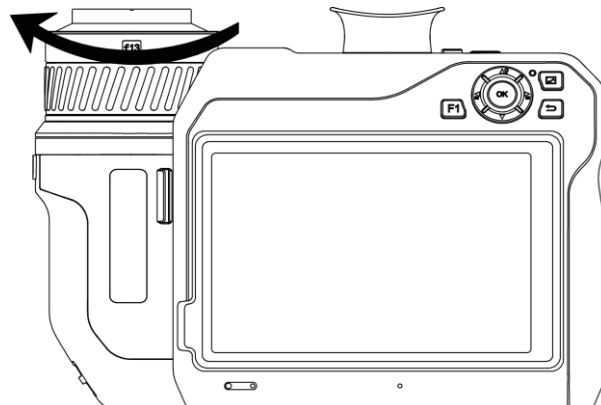

Figure 2-10 Fix Lens



A prompt pops up on the interface if the lens is not calibrated to the camera. Please contact the dealer or the nearest service center for lens calibration, or the temperature measurement accuracy is affected.

2.4 Detector Cleaning

Dust on the detector may cause blemishes in the image. To avoid detector damage, we recommended you to contact the nearest dealers or our service centers for help.

If you have to clean the detector on your own, please follow the steps:

Before You Start

- Prepare a pair of rubber gloves or rubber finger cover (not included).
 - Prepare a compressed air canister (not included), a cleanroom wiper and a bottle of anhydrous ethanol (not included).
1. Remove the interchangeable lens carefully. Please see [2.3](#) for detailed information.
-



Wear a pair of rubber gloves or rubber finger cover before cleaning, in case of the chemical corrosion or the remaining fingerprints.

2. Use pressurized air from a compressed air canister to blow the dust off.
 3. If there still have blemishes, use a supplied cleanroom wiper dipped in anhydrous ethanol to wipe it.
-



Please wipe the detector gently in a fixed direction.

2.5 Mount Hand Strap

1. Thread the hand strap through the hand strap clutch.



Figure 2-11 Thread Hand Strap

2. Insert one end of the hand strap through the two hand strap attachment points.

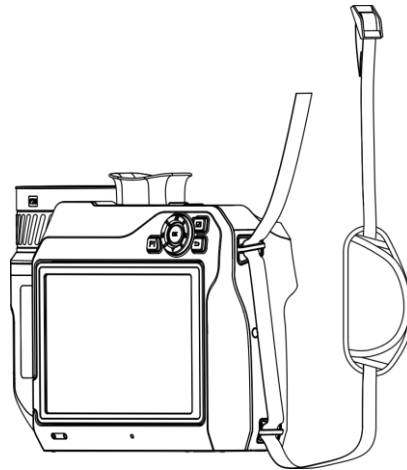

Figure 2-12 Thread Hand Strap Through Attachment Points

3. Thread hand strap through the hand strap buckle, and fasten the hand strap.

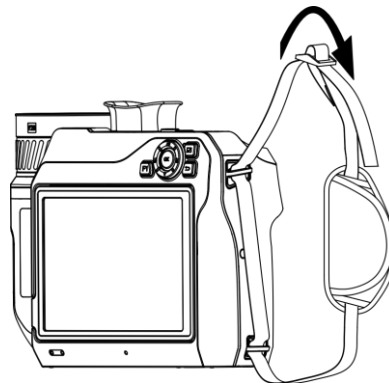

Figure 2-13 Fasten Hand Strap

4. Adjust the tightness of the hand strap as needed.

2.6 Mount Neck Strap

1. Insert one end of the neck strap through a neck strap attachment point.
2. Thread the neck strap through the buckle, and fasten the neck strap.

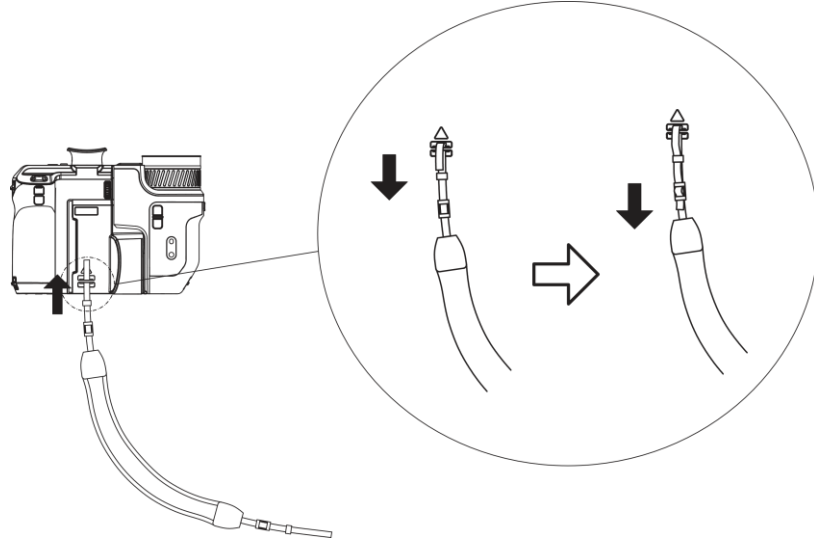

Figure 2-14 Fasten Hand Strap

3. Repeat above steps to complete mounting the neck strap.

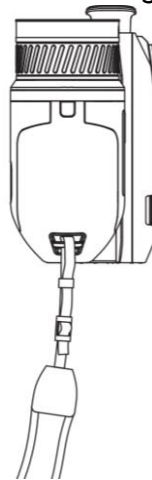

Figure 2-15 Install the Other End

2.7 Tilt Lens and Screen

You can tilt the lens and screen for different observation angles, as shown in Figure 2-16.

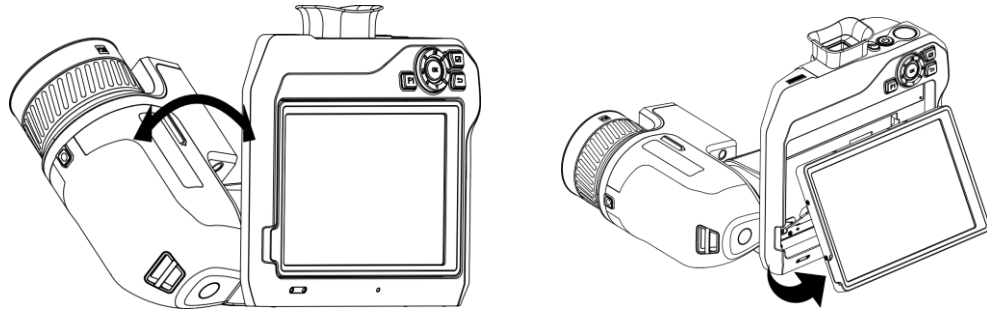



Figure 2-16 Tilt Lens and Screen

2.8 Power On/Off

Power On

Remove the lens cover, and hold  for over three seconds to turn on the device. You can observe the target when the interface of the device is stable.



- It may take at least 30 s until the device is ready for using when you power on it.
 - It is necessary to set system language and time and date when you power on the device for the first time. Press  to save and exit.
-

Power Off

When the device is turned on, hold  for three seconds to power off the device.

Auto Power-off

Select , and go to **Device Settings > Auto Power-off** to set the automatic shutdown time for device as required.

2.9 Sleep and Wake

Sleep and wake function is used to save energy and increase battery time.

Sleep and Wake Manually

Press  to enter sleep mode and press it again to wake the device up.

Set Auto Sleep

Select , and go to **Device Settings > Auto Sleep** to set waiting time before auto sleep. When there is no button pressing or screen tapping operation on device for more than the set waiting time, device enters sleep mode automatically.

Press  to wake the device up.

Device Sleep, Scheduled Capture and Video Recording

When the device is recording a video clip or on scheduled capturing, auto sleep will not be triggered. However, press  will stop the video recording or scheduled capture and force the device into sleep mode.

2.10 Operation Method

The device supports both touch-screen control and button control.

Touch-Screen Control

Tap the screen to set parameters and configurations.

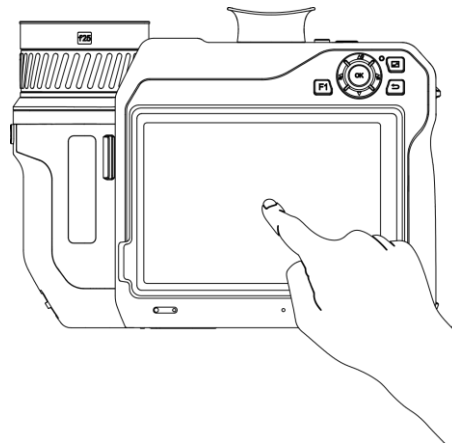

Figure 2-17 Touch-screen Control

Button Control

Press the navigation buttons to set parameters and configurations.

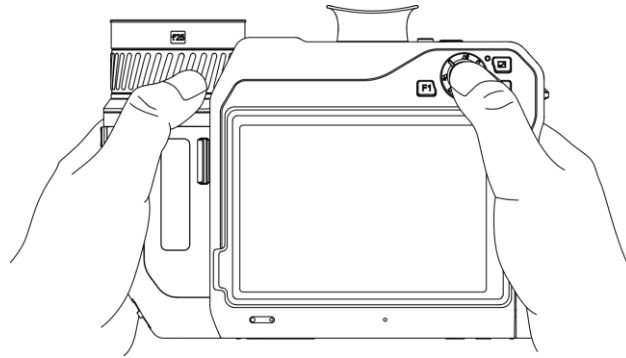

Figure 2-18 Button Control

- In menu mode, press Δ , ∇ , \square , and \blacktriangleright to select parameters.
- Press **OK** to confirm.

2.11 Menu Description

In the observation interface, tap the screen to show the menu bar, and swipe down the 1/3 area on the top of the screen to call the swipe-down menu.

2.11.1 Live View Interface

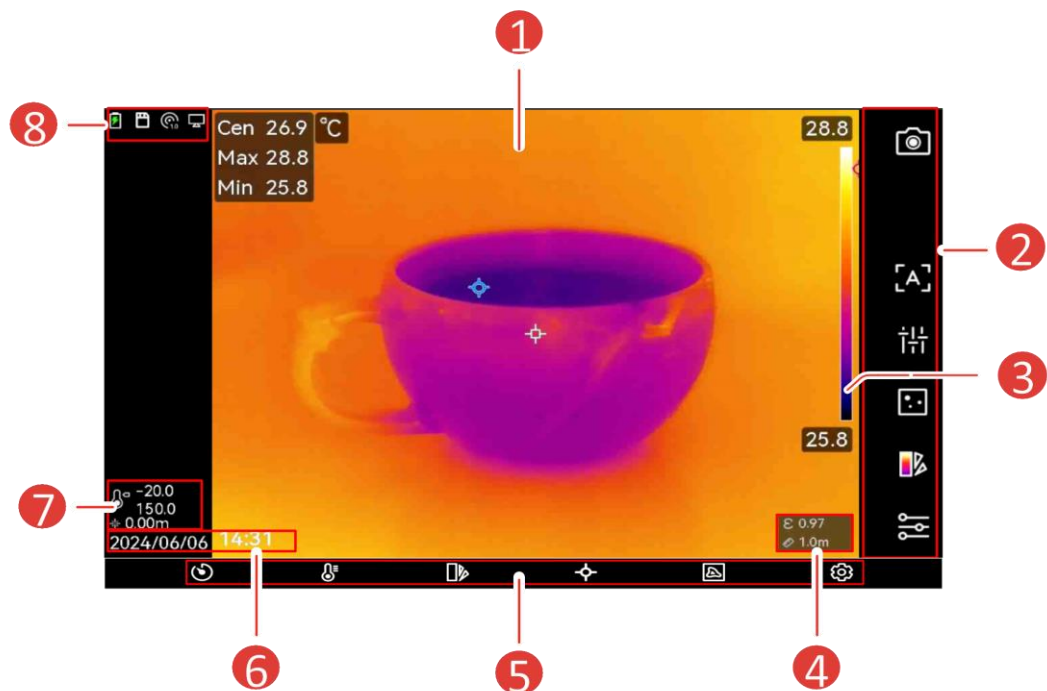

Figure 2-19 Live View

Table 2-1 Live View Interface Description







No.	Descriptions
1	Live view interface. Display the thermal images of the target and its real-time temperature values.
2	Shortcut bar. Record/camera mode, focus mode, level & span mode, display mode, palettes, and measurement settings support quick operation.
3	<p>Palette bar and display temperature range. The upper and lower values of the palette bar represent the max. temperature and the min. temperature of the current display temperature range.</p> <hr/>  <p>If a "~" appears before a temperature value, it means that your device is not well prepared for accurate temperature measurement. Take target temperatures when the sign disappears.</p> <hr/>
4	Emissivity and Distance. Display the emissivity of the target and the observation distance between the target and the device.
5	Menu. Please see 2.11.2 for more details.
6	Time and date. Display the system time.
7	Temperature range and measured distance with laser. Display the set temperature measurement range and measured the distance with laser.
8	Status bar, where device working status, such as, battery and connections, are displayed. Please see Table 2-2 for more details.

Table 2-2 Description of Status Display

Status Display	Description
	Battery Status
	The device is connected to PC via Type-C cable.
	Wi-Fi is connected.
	Memory Card is inserted.
	Bluetooth is on.























Status Display	Description
	Interchangeable Lens is mounted on the device and the interchangeable lens type is on the bottom right of the icon.
	The inspection data is transmitting to the device.
	Cast Screen is on.
	Compass is on. The number stands for the calibration level. Numbers smaller than 3 mean that the compass is not properly calibrated and the direction displayed might not be correct.
	Show current temperature measurement range. The device only measures the temperatures in the range. Tap  > Temp Measurement Settings > Temperature Range to change working range.
	Display measured distance with laser. Tap  > Display Settings > Distance to switch it on/off.
	Display the longitude and latitude of the device. Tap  > Device Settings > GPS to switch it on/off.
	Display the device location. Tap  > Device Settings > Compass to switch it on/off.

Table 2-3 Description of Shortcut Function

Icon	Description
	Tap to take snapshots and record videos. <ul style="list-style-type: none"> ● Tap  to take snapshots.  is in picture capture progress. Tap  to stop. ● Press and hold  to record videos.  is in video recording progress. Tap  to stop.
	Tap to switch focus mode. Please see 3.1 for more details.
	Tap to switch manual and auto level & span. Please see 3.5 for more details.
	Tap to switch display mode. Please see 3.3 for more details.

Icon	Description
	Tap to switch palettes. Please see 3.4 for more details.
	Tap to set temperature measurement parameters such as humidity, emissivity, distance, and temperature. Please see 4.1 for more details.

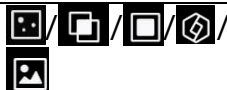





2.11.2

Main Menu



Figure 2-20 Main Menu

Table 2-4 Description of Main Menu

Icon	Description	Icon	Description
	Shutter. Tap to calibrate image one time (FFC).		Temperature Measurement Tool. Tap to set temperature measurement tools. Please see 4.3 for more details.
	Level & Span. Please see 3.5 for more details.		Display Mode. Tap to switch display modes. Please see 3.3 for more details.
	Palettes. Please see 3.3 for more details.		Settings

2.11.3

Swipe-Down Menu

In live view interface, swiping on the screen from upper to lower to call the swipe-down menu. With this menu, you can turn on/off device function, change display theme, and adjust screen brightness.



Tap and hold Wi-Fi, Hotspot, and Bluetooth icon in swipe-down menu to enter corresponding configuration interface.

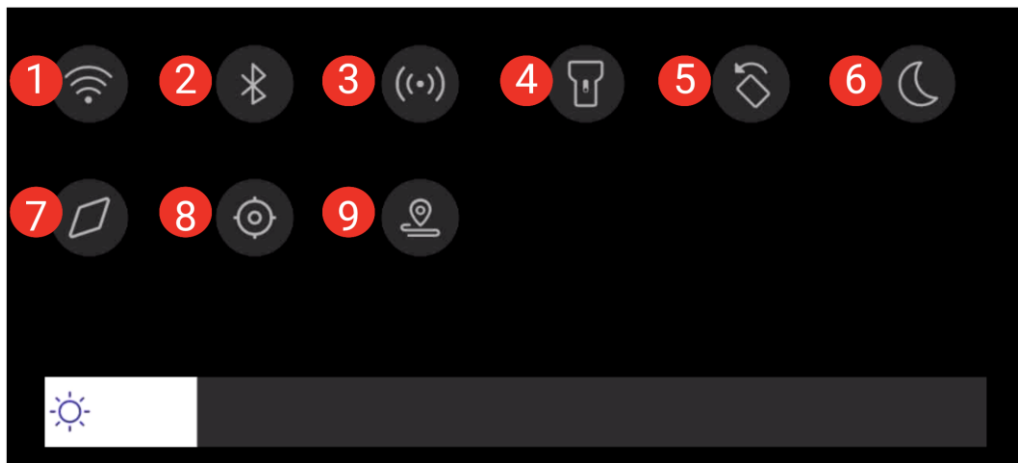

Figure 2-21 Swipe-down Menu

Table 2-5 Swip-down Menu Table

No.	Function
1	Wi-Fi
2	Bluetooth
3	Hotspot
4	Flashlight
5	Auto-Rotation
6	Dark/Bright Mode
7	Compass
8	GPS
9	Inspection Mode

3 Display Settings



Your device will periodically perform a self-calibration to optimize image quality and measurement accuracy. In this process the image will pause briefly and you'll hear a "click" as a shutter moves in front of the detector. The self-calibration will be more frequent during start up or in very cold or hot environments. This is a normal part of operation to ensure optimum performance for your device.

3.1 Focus

Adjust the lens focal length properly before you set any other configurations, or it may affect the image display and temperature accuracy.

3.1.1 Focus Lens

1. Power on the device.
2. Aim the device lens to the appropriate scene.
3. Adjust the focus ring clockwise or anticlockwise until the target is clear.

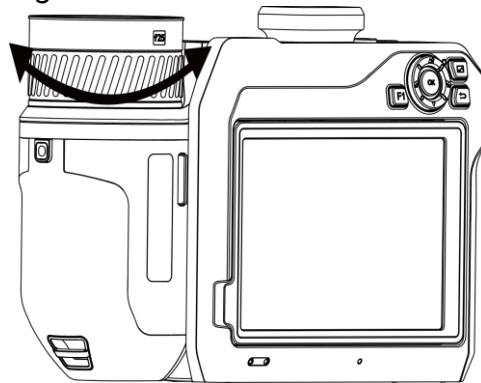

Figure 3-1 Focus Lens



DO NOT touch the lens, or the imaging effect may be affected.



3.1.2 Laser Assisted Focus

Aim the laser to the target and the device focuses automatically.

Before You Start

It is recommended to use this function in a non-glare environment, such as indoor environment.

The target should have good light reflection, such as white paper and cables.

1. Enable **Laser Assisted Focus** by the following ways:
 - Select , and go to **Capture Settings > Focus > Thermal Focus Mode** to enable **Laser Assisted Focus**.
 - In live view, tap the focus shortcut key in shortcut bar and switch to **Laser Assisted Focus** .
 2. In the live view interface, aim image center at the target and press  to finish focus.
 3. When you see a red dot displayed in the image center and a laser dot at the target, release the trigger to start focusing automatically.
-





The laser radiation emitted from the device can cause eye injuries, burning of skin or inflammable substances. Prevent eyes from direct laser. Before enabling the function, make sure no human or inflammable substances are in front of the laser lens.

4. Optional: If the focusing effect is not satisfactory, slightly adjust the focus ring for better image.

3.1.3 Auto Focus

The device focuses automatically in current scene by comparing the brightness, contrast, etc. In this mode, you can pull the trigger or touch the screen to focus.

1. Enable **Auto Focus** by the following ways:
 - Select , and go to **Capture Settings > Focus > Thermal Focus Mode** to enable Auto Focus.
 - In live view, tap the focus shortcut key in shortcut bar and switch to **Auto Focus** .
 2. In the live view interface, aim image center at the target and press  to finish focus. The device adjusts its focus on targets in the image center.
-

- Optional: If you want to switch the focus to other objects, tap the desired screen area to adjust the focus.



- DO NOT adjust the focus ring when the device is auto focusing, otherwise it will interrupt the auto focusing process.
- If the target is not clearly focused in this mode, adjust the focus ring to fine-tune the image.

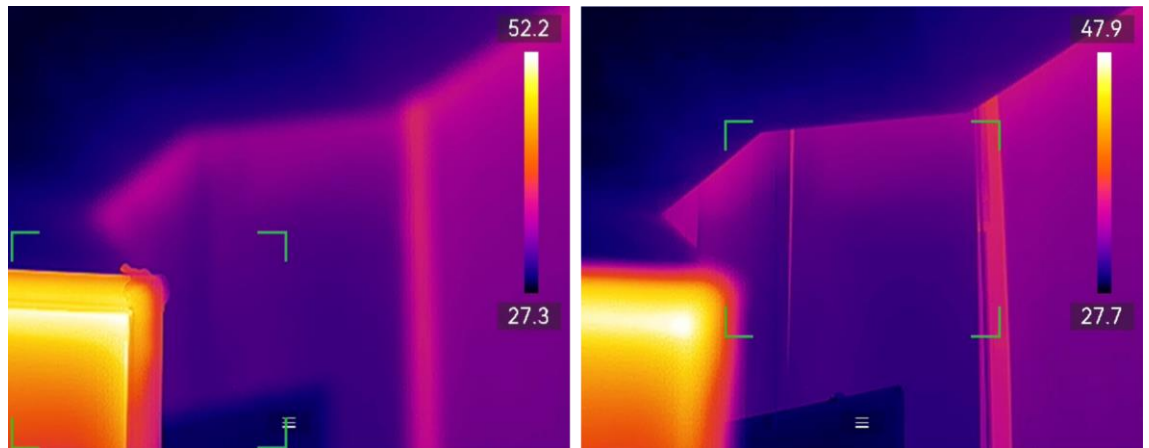

Figure 3-2 Switch Focus Object

3.1.4 Continuous Autofocus

In continuous autofocus mode, the device focuses on the target automatically to make the scene clear. Use this mode when the device is stationary.



Disable continuous autofocus mode when the device is moving, or it may affect the device function.

You can enable **Continuous Autofocus** by the following ways:

- Select , and go to **Capture Settings > Focus > Thermal Focus Mode** to enable **Continuous Autofocus**.
- In live view, tap the focus shortcut key in shortcut bar and switch it to **Continuous Autofocus** [C].

Then aim the device at the target, and the device focuses automatically.



Focus ring adjustment does not take effect in this mode.

3.1.5 High Temperature Priority

Enable the high temperature priority function if you want to focus on the high temperature object in the observation scene.

Select , and go to **Capture Settings > Focus** to enable **High Temperature Priority**.





The high temperature priority function is only supported in auto focus mode and continuous autofocus mode.

3.2 Set Screen Brightness

The device supports auto or manual screen brightness adjustment.

Table 3-1 Table 3-1 Screen Brightness Adjustment

Method	Operation
Manual	Select  , and go to Settings > Device Settings > Screen Brightness to adjust the screen brightness. Or tap  , and drag it to adjust the screen brightness.
Auto	Select  , and go to Settings > Device Settings > Screen Brightness to enable Auto. Device adjusts the screen brightness automatically when the ambient brightness changes.

3.3 Set Display Mode

You can set the thermal/optical view of the device. **Thermal, Fusion, PIP, Visual, and Blending** are selectable.

- Switch the display mode by the following ways:
 - Select  from the main menu, and tap the icons to select a display mode.
 - In live view, tap the focus shortcut key in shortcut bar and switch display mode.



In thermal mode, the device displays the thermal view.



In fusion mode, the device displays the thermal image of the live view outlined from visual image.



In PIP (Picture in Picture) mode, the device displays thermal view inside the optical view.



You can drag the corners of the PIP frame to move, enlarge, or contract it.



In blending mode, the device displays the mixture view of thermal channel and visual channel. You can adjust the **Level** to change the optical-thermal ratio. The lower the value is, the denser the visual effect is.



In visual mode, the device displays the visual view.

2. Press  to exit.

3.4 Set Palettes

The palettes allow you to select the desired colors.



Switch palettes via  from the main menu, or  in the shortcut bar. Available common palettes are:

Table 3-2 Table of Different Palettes

Palettes	Description
White Hot	The hot part is light-colored in view.
Black Hot	The hot part is black-colored in view.
Rainbow	The target displays multiple colors. It is suitable for scene without obvious temperature difference.
Ironbow	The target is colored as heated iron.
Red Hot	The hot part is red-colored in view.
Fusion	The hot part is yellow-colored and the cold part is purple-colored in view.
Rain	The hot part in the image are colored, and the else is blue.
Blue Red	The hot part in the image is colored red, and the else is blue.



- You can also press and to switch the palettes.
- It is available to show or hide the palettes bar in live view. Tap > **Display Settings > Temperature Scale.**

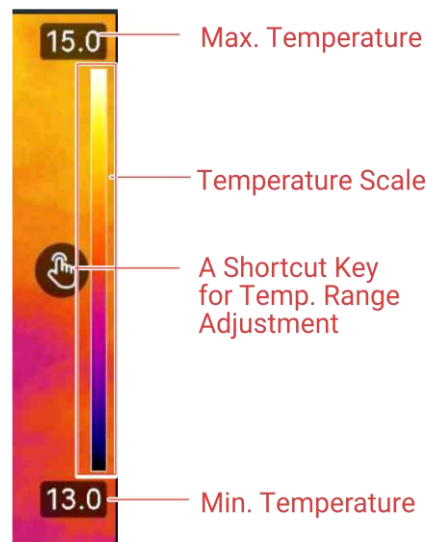

3.4.1 Set Alarm Mode Palettes

Alarm mode palettes allows to mark the targets of certain temperature range with a different color from the rest.

1. Select from the main menu.













2. Tap  to get more options.
3. Tap the icons to select an alarm tool.

Table 3-3 Icon Description

Icon	Alarm Mode	Description
	Above Alarm	Set the alarm temperature, and the targets with the temperature higher than the set value are displayed in red.
	Below Alarm	Set the alarm temperature, and targets with the temperature lower than the set value are displayed in blue.
	Interval Alarm	Set the alarm temperature section (e.g., 90 °C to 150 °C), and targets with the temperature in the range are displayed in yellow.
	Insulation Alarm	<p>According to the set values of Indoor Temp. and Outdoor Temp., the device calculates the insulation value based on the built-in rules, and detects whether the insulation value of the target internal surface exceeds Insulation Level (normally 60 ~ 80). The area with insulation anomalies outside of the range is displayed in cyan.</p> <hr/>  <ul style="list-style-type: none"> ● It is suggested to set Insulation Level in 60 ~ 80. Higher the value is, stricter requirements on insulation the target will have. ● It is suggested to go indoors and observe the target for result accuracy.

4. Set temperature values.
 - Press  and  to select between upper limit and lower limit. Press  and  to adjust the temperature.
 - Tap on the screen to select an interest area. The device automatically adjusts the upper and lower temperature limit of the selected scene. Press  and  to fine-tune the temperature.



You can tap </> on the left or right side of the value box to adjust the values. Press and hold to quickly adjust the values.

5. Press ↩ to exit.

3.4.2 Set Focus Mode Palettes

Focus mode palettes allows to mark the targets of certain temperature range with fusion palettes and the others with white hot palettes.





1. Select  from the main menu.
2. Tap the icons to select an alarm tool.

Table 3-4 Table 3-3 Icon Description

Icon	Palettes Mode	Description
	Above Focus	Set the temperature threshold, and the targets with the temperature higher than the set value are displayed with fusion palettes.
	Below Focus	Set the temperature threshold, and targets with the temperature lower than the set value are displayed with fusion palettes.
	Interval Focus	Set the temperature range (e.g., 90 °C to 150 °C), and targets in the range are displayed with fusion palettes.

3. Set a temperature range.
 - Press ▲ and ▼ to select between upper limit and lower limit. Press ◀ and ▶ to adjust the temperature.
 - Tap on the screen to select an interest area. The device automatically adjusts the upper and lower temperature limit of the selected scene. Press ◀ and ▶ to fine-tune the temperature.

4. Press ↩ to exit.

3.5 Adjust Level & Span

Set a temperature range and the palette only works for targets within the temperature range. You can adjust the temperature range.















1. Select  from the main menu.
2. Select auto adjustment  or manual adjustment . Or Tap  in the shortcut bar to quickly switch between auto and manual level & span.
 - **Auto adjustment** : The device adjusts temperature range parameters automatically.
 - **Manual adjustment** : Adjust the range manually. **Level Only** and **Level or Span** modes are selectable.
3. For Manual mode, go to  > **Temp Measurement Settings** > **Manual Level and Span Mode** to choose a preferred mode. **Level Only** and **Level or Span** are selectable.

Table 3-5 Manual Level & Span

Mode	Mode Description	Operation
Level Only	You can adjust the maximum temperature and the minimum temperature respectively to expand or reduce the temperature range.	<ol style="list-style-type: none"> 1. Tap an interest area on screen. A circle is displayed around the area, and the temperature range re-adjusts to show as many details of the area as possible. 2. Press  and , or tap the value on screen to lock or unlock a value. 3. Press  and , or scroll the adjustment wheel on screen to fine-tune the max. temperature and the min. temperature respectively. 4. Tap OK to finish.
Level & Span	You can adjust the maximum temperature and the minimum temperature at the same time while remaining the same temperature range.	<ol style="list-style-type: none"> 1. Tap on an interest area on screen. A circle is displayed around the area, and the temperature range re-adjusts to show as many details of the area as possible. 2. Press  and  to fine-tune the max. temperature and the min. temperature respectively. 3. Tap OK to finish.



In Manual Level and Span mode, press  on the left side of temperature scale to quickly adjust the temperature range.

3.6 Set Color Distribution

Color distribution function provides different image display effects in auto level & span. Linear and histogram color distribution modes can be selected for different application scenes.

1. Select , and go to **Device Settings > Color Distribution**.

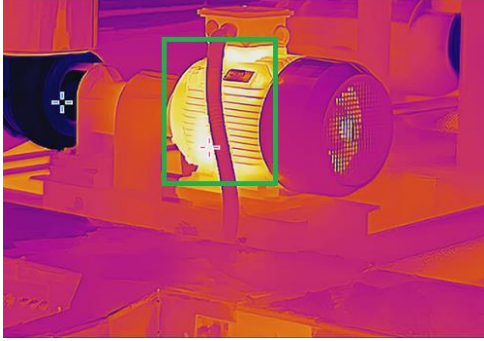
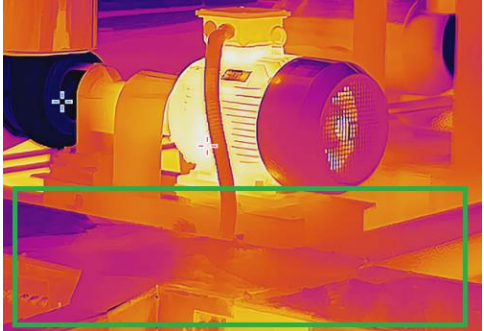

2. Select a color distribution mode.

Table 3-6 Color Distribution

Mode	Description
Linear	<p>Linear mode is used to detect small high temperature targets in low temperature background. Linear color distribution enhances and displays more details of high temperature targets, which is good for checking small high temperature defective areas such as cable connectors.</p> 
Histogram	<p>Histogram mode is used to detect temperature distribution in large areas. Histogram color distribution enhances high temperature targets and remains some details of low temperature objects in the area, which is good for discovering small low temperature targets such as cracks.</p> 

3. Press  to exit.

3.7 Adjust Digital Zoom



In the live view interface, press  and  to zoom in or zoom out by 0.1× continuously.

Hold  and  to zoom in or zoom out by 1×, 2×, etc.

3.8 Set Auto-Rotation

The device supports display auto-rotation where the status bar, shortcut bar and main menu shift from the horizontal direction to the vertical direction.

Switch on the auto-rotation function as follows:

- In live view, swipe down 1/3 area on the top of the screen to enter the swipe-down menu, and tap .
- Tap  > **Device Settings** > **Auto-Rotation**.



In the vertical direction, tap  in live view, and the main menu appears.

3.9 Display OSD Info

Select , and go to **Display Settings** to enable the information on-screen display.

Table 3-7 Display Settings

Function	Description
Status Icon	The device status icons, for example, battery status, memory card, hotspot, etc.
Time and Date	Device time and date.
Parameters	Thermography parameters, for example, target emissivity, temperature unit, etc.
Distance	Laser measurement result.
Brand Logo	The brand logo is a manufacturer logo displayed on the upper right corner of the screen.
Temperature Scale	Display the palettes bar and temperature range on the right side of the screen.

4 Temperature Measurement

The temperature measurement function provides the real-time temperature of the scene and displays it on the left corner in live view interface.



Your device will periodically perform a self-calibration to optimize image quality and measurement accuracy. In this process the image will pause briefly and you'll hear a "click" as a shutter moves in front of the detector. The self-calibration will be more frequent during start up or in very cold or hot environments. This is a normal part of operation to ensure optimum performance for your device.

4.1 Set Measurement Parameters

You can set measurement parameters to improve the accuracy of temperature measurement.

1. Select  and go to **Temp Measurement Settings**.
2. Set **Temperature Range**, **Emissivity**, etc.

Temperature Range

Select the temperature measurement range. The device can detect the temperature and switch temperature range automatically in **Auto Switch** mode.

Emissivity

Set the emissivity of your target.

Reflection Temperature

If any object (not the target) of high temperature is in the scene, and the target emissivity is low, set the reflection temperature as the high temperature to correct the temperature effect.

Ambient Temperature

Set the temperature for the observation environment. Swipe up and down to adjust the values.

Distance

The distance between the target and the device. You can customize the target distance or select the target distance as **Near, Middle, or Far**.

Humidity

Set the relative humidity of current environment.

External Optics Transmittance

Set the optics transmittance of external optical material (e.g.: germanium window) to improve the temperature measuring accuracy.

External Optics Temperature

Set temperature of the external optical material (e.g.: germanium window).



When you install a macro lens, the device switches to macro mode automatically. In macro mode, settings such as display mode, distance, and optical transmissivity cannot be modified.

3. Return to previous menu to save the settings.





Select , and go to **Device Settings > Device Initialization > Remove All Measurement Tools** to initialize the temperature measurement parameters.

4.2 Set Image Measurement

You can set three types of temperature measurement tools.

Table 4-1 Icon Description

Icon	Description
	Hot Spot Temperature Measurement
	Cold Spot Temperature Measurement
	Center Spot Temperature Measurement

The setting methods of center spot, hot spot, and cold spot temperature measurement are all the same. Here is the example of image measurement.

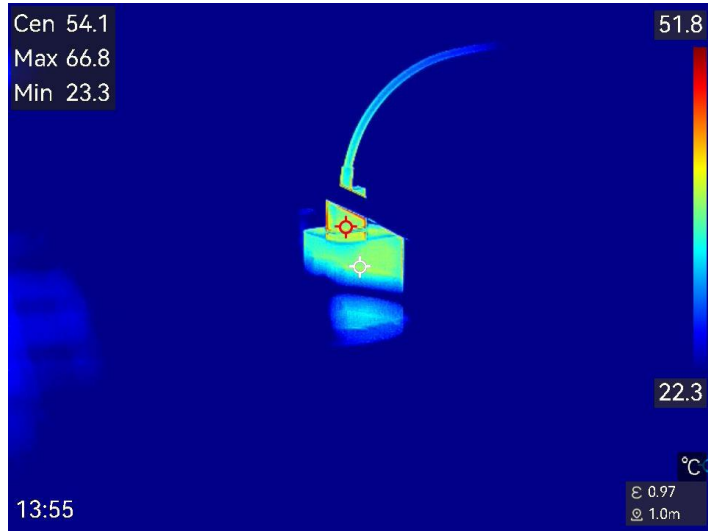

Figure 4-1 Image Measurement

4.3 Set Measurement Tool

You can set temperature measurement parameters to improve the accuracy of temperature measurement.

Before You Start

Set parameters such as **Humidity**, **External Optics Transmittance** and **Reflection Temperature**. For detailed explanations, see [Set Measurement Parameters](#).

1. Tap  to call the measurement tool bar.
2. Select a temperature measurement tool.

Table 4-2 Measurement Tools

Tool Name	Descriptions
Custom Spot	For configuring custom spot tools, see Measure by Custom Spot .
Line	For the configuring line tools, see Measure by Line .
Rectangle	For the configuring rectangle tools, see Measure by Rectangle .
Circle	For the configuring circle tools, see Measure by Circle .
ΔT	For the configuring ΔT tools, see Measure ΔT and ΔT Alarm .



Figure 4-2 Temperature Measurement Tools

What to do next

Set temperature alarm, then alarm actions such as audible warning and flashing alarm will be triggered when the tested temperature exceeds the set alarm value. See *Temperature Alarm*.

4.3.1 Measure by Custom Spot

The device can detect the temperature of a custom spot.

1. Tap to add a default spot.
2. Move the spot with the navigation buttons, or tap on the touch-screen to select a spot and move it.
3. Tap to modify temperature measurement parameters.

Table 4-3 Measurement Parameters of Custom Spot

Parameters	Description
Emissivity	Set the emissivity of your target.
Distance	Set the distance between the target and the device.
Temp.	Tap to display or hide the temperature measurement result.

4. Press .

The temperature of custom spot (e.g. P1) displays P1: XX.



If the tool-specific emissivity and distance are set, the measurement is conducted based on the parameters. Otherwise, the parameters set from **Temp Measurement Settings** are used for measurements.

5. Tap to add more custom spots.



- At most ten custom spots are supported.
 - Drag the spot tool list on the left of the screen, or press and to view the whole tool list.
-

6. Optional: Modify the set custom spot tools, hide or display the tools and measurement results, etc.



Tap to enter the editing interface and modify temperature measurement parameters such as emissivity and distance.



Tap to hide or display the tool and measurement results.



Tap to delete the tool.

7. Press to save and exit.

4.3.2

Measure by Line

1. Tap to generate a default line.



Only one line tool is supported.

2. Move the line to the required position.
 - Tap the line, and press and to move the line up/down/left/right.
 - Tap the line on touch-screen and drag it to the required position.
3. Adjust the length of the line.
 - Tap the end of the line, and press and to extend or shorten the line.
 - Tap and drag the end of the line to extend or shorten it.
4. Tap to modify temperature measurement parameters.

Table 4-4 Measurement Parameters of Line Tool

Parameters	Description
Emissivity	Set the emissivity of your target.
Distance	Set the distance between the target and the device.
Max./Min./Average Temperature	Tap to enable the temperature types to display. The max. temperature, min. temperature, and average temperature of the line can be displayed on the left of the screen.

5. Press .



If the tool-specific emissivity and distance are set, the measurement is conducted based on the parameters. Otherwise, the parameters set from **Temp Measurement Settings** are used for measurements.

6. Modify the set line tool, hide or display the tool and measurement results, etc.



Tap to enter the editing interface and modify temperature measurement parameters such as emissivity and distance.







Tap to hide or display the tool and measurement results.







Tap to delete the tool.

7. Press  to save and exit.

4.3.3 Measure by Rectangle

1. Tap  to generate a default rectangle.
2. Move the rectangle to the required position.
 - Tap the rectangle, and press , ,  and  to move the rectangle up/down/left/right.
 - Tap and drag the rectangle on touch-screen to move it to the required position.
3. Adjust the size of the rectangle.

- Tap one corner of the rectangle, and press , ,  and  to enlarge or contract the rectangle.
- Tap and drag the corner of the rectangle on touch-screen to enlarge or contract it.

4. Tap  to modify temperature measurement parameters.

Table 4-5 Measurement Parameters of Rectangle Tool

Parameters	Description
Emissivity	Set the emissivity of your target.
Distance	Set the distance between the target and the device.
Max./Min./Average Temperature	Tap to enable the temperature types to display. The max. temperature, min. temperature, and average temperature of the rectangle can be displayed on the left of the screen.

5. Press  to save the settings.



If the tool-specific emissivity and distance are set, the measurement is conducted based on the parameters. Otherwise, the parameters set from **Temp Measurement Settings** are used for measurements.

6. Tap  to add more rectangle tools.



At most five rectangle tools are supported.

7. Optional: Modify the rectangle tools, hide or display the tools and measurement results, etc.



Tap to enter the editing interface and modify temperature measurement parameters such as emissivity and distance.



Tap to hide or display the tool and measurement results.



Tap to delete the tool.

8. Press  to save and exit.

4.3.4 Measure by Circle











1. Tap  to generate a default circle.
2. Move the circle to the required position.
 - Tap the circle, and press , ,  and  to move the circle up/down/left/right.
 - Tap and drag the circle on touch-screen to move it to the required position.
3. Adjust the size of the circle.
 - Tap one point on the circle, and press , ,  and  to enlarge or contract the circle.
 - Tap and drag one point of the circle on touch-screen to enlarge or contract it.
4. Tap  to modify temperature measurement parameters.

Table 4-6 Measurement Parameters of Circle Tool

Parameters	Description
Emissivity	Set the emissivity of your target.
Distance	Set the distance between the target and the device.
Max./Min./Average Temperature	Tap to enable the temperature types to display. The max. temperature, min. temperature, and average temperature of the circle can be displayed on the left of the screen.

5. Press  to save the settings.



If the tool-specific emissivity and distance are set, the measurement is conducted based on the parameters. Otherwise, the parameters set from **Temp Measurement Settings** are used for measurements.

6. Tap  to add more circle tools.



At most five circle tools are supported.

7. Optional: Modify the circle tools, hide or display the tools and measurement results, etc.



Tap to enter the editing interface and modify temperature measurement parameters such as emissivity and distance.



Tap to hide or display the tool and measurement results.



Tap to delete the tool.

8. Press to save and exit.

4.4 Measure ΔT and ΔT Alarm

By comparing the temperature difference (ΔT) between measurement tools, or between a measurement tool and a certain temperature, device can recognize temperature exception more accurately and rapidly. This function is commonly applied to the temperature measurement of temperature-sensitive targets such as current transformers.

Before You Start

Configure at least one temperature measurement tool.

- For configuring custom spot tools, see [*Measure by Custom Spot*](#).
- For the configuring line tools, see [*Measure by Line*](#).
- For the configuring rectangle tools, see [*Measure by Rectangle*](#).
- For the configuring circle tools, see [*Measure by Circle*](#).

1. Tap

2. Add a ΔT tool.

- 1) Input a tool name for the ΔT tool in **Name of Tool**.
- 2) Select Compared Object.



You can compare the temperature difference between different or the same measurement tools, between a measurement tool and a number, etc. If you select **Number** as a compared object, input the value manually.

- 3) Set Alarming ΔT : When the detected ΔT is greater than the set alarming ΔT , device triggers alarms.
- 4) Tap OK to save the settings.

3. Optional: Repeat above steps to set other ΔT tools.

4. Optional: Modify the ΔT tools, hide or display the tools and measurement results, etc.



Tap to enter the editing interface and modify ΔT tool parameters such as emissivity and distance.





Tap to hide or display the ΔT tool and measurement results.



Tap to delete the ΔT tool.

5. Press  to save and exit.

6. Enable **ΔT Alarm**.

- 1) Select , and go to Temp Measurement Settings > Alarm Settings.
- 2) Slide  to enable **ΔT Alarm**.



If you do not enable **ΔT Alarm**, the alarm linkages also take effect, but the ΔT alarm information will not be uploaded to the surveillance center.

4.5 Temperature Alarm

When the temperature of targets triggers the set alarm, the device will perform configured actions, such as, flashing the rule frame, making an audible warning, or sending notification to the client software.

4.5.1 Set Alarms for Exceptional Temperatures

Alarm actions such as audible warning and flashing alarm are triggered when the tested temperature exceeds the set alarm value.

1. Select , and go to **Temp Measurement Settings > Alarm Settings**.
2. Set alarm parameters.

Alarm Threshold

When the tested temperature exceeds the threshold, the device sends alarm notification to the client software. It beeps if the **Audible Warning** is enabled. It flashes if the **Flashing Alarm** is enabled.

Alarm Linkage

- **Audible Warning:** The device beeps when target temperature exceeds the alarm threshold.
- **Flashing Alarm:** The flash light flashes when target temperature exceeds the alarm threshold.



If you set rectangle and circle tools to measure temperature, the alarm threshold and linkage method settings only works in the measured areas. Otherwise, the parameters are valid for pixel-to-pixel temperature measurement (whole-screen temperature measurement).

-
- **Alarm Capture:** The temperature values in live view interface turns red when target temperature exceeds the alarm threshold, and the device captures pictures and saved them to local albums automatically.



- When you reboot the device, **Alarm Capture** remains the last operation status.
- The captured pictures for **Alarm Capture** highlights the exceptional temperature in red.

-
- **Min. Alarm Interval:** Set the minimum interval for saving the alarm captured pictures.

3. Tap  to enable Temperature Alarm.

4.6 Calculate Area Size

The device can calculate the size of rectangles and show results on screen.

1. Select , and go to **Measurement Settings > Area Size Calculation**.
2. Enable **Area Size Calculation**.
3. Draw one or several rectangles on screen.

The rectangles are those you draw for temperature measurement. See ***Measure by Rectangle*** for instructions.

4. In the live view interface, aim a rectangle at the target and press the laser button.



Make sure the lens is parallel to the target when measuring the area size.

Result



The target size is displayed above the rectangle.

4.7 Clear All Measurements

Tap  to clear all set temperature measurement tools.



5 Condensation Alarm

Condensation Alarm marks the surface in green where the relative humidity exceeds the set threshold.

1. Tap  in live view to enter alarm palettes setting interface.
2. Tap  to show more options.
3. Tap  to enter condensation alarm interface.
4. Set parameters:
 - **Threshold:** The surface humidity threshold. Anywhere with higher humidity in the scene is marked with green.
 - **Ambient Temp.:** The environmental temperature around the target for humidity measurement accuracy.
 - **Relative Humidity:** The environmental relative humidity of the target for humidity measurement accuracy.



Ambient temperature and relative humidity should be adjusted each time you set condensation alarm, as they are affected by locations and weather. It is available to browse Weather application in your phone.

5. **Optional:** Tap  to adjust parameter values.
6. Tap **OK** or Press  to save and exit.

6 Route Inspection

In certain situation that requires temperature check for many inspect points, you can use the client software to create inspection routes that cover all the points and send a route inspection task to the device. After the device examines the temperatures of the inspect points, it uploads the results to the client software.

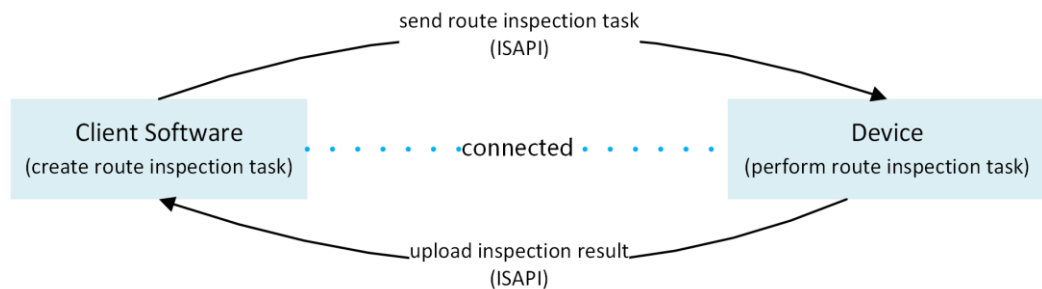

Figure 6-1 Route Inspection Work Flow

The device receives the tasks from and uploads the inspection results to the PC client software by its WLAN or Hotspot function.

6.1 Create Inspection Route and Send Task to Device

Create the inspection routes on the HIKMICRO Inspector. The client should be connected to the device before sending the route inspection task.

Before You Start

- Contact our technical support to get the HIKMICRO Inspector client software. Install the software to your PC.
- The PC should support WLAN function.

1. Open HIKMICRO Inspector.
2. Create inspect points and routes. See the user manual of HIKMICRO Inspector for instructions.
3. Connect your device and PC to the same LAN, and add your device into the client. Please see [11.3 Connect Device to HIKMICRO Inspector](#).
4. Go to **Task Management > Route Management** to select a route and click **Apply to Device**.

What to do next

Check your device to see if the task is successfully received.

6.2 Perform Route Inspection

After receiving inspection tasks from the PC client, you can hold the device and check the inspect points on the route. Upload the results when the inspection is finished.

Before You Start

- Make sure your device has a memory card installed. See *Appearance* for instructions.
- Connect the device to the PC client, and make sure that your device has received inspection tasks from the PC client. See the user manual of HIKMICRO Inspector for instructions of applying inspection task to the device.
- Use HIKMICRO Inspector v1.2.0.100 or newer versions to acquire full product functionality. Otherwise, operations mentioned below may not be available. Contact our technical support to get the software.

1. Enter inspection mode to start.

Enter the mode by one of the following ways:

- Tap  in the swipe-down menu to enter the inspection route mode.
- Go to **Settings > Device Settings > Inspection Route Mode** to enable the function.



When in the inspection route mode, the device files are not accessible.

2. Press  to enter the inspection task list.
3. Tap to select a task to start.



The font of task in progress is blue on the list.

4. Browse the inspect points and check the inspection requirements for each point.
 - 1) Tap the task to enter the task interface.

- 2) Press Δ and ∇ to select an inspect point and check the point details.
- Before inspecting points, check the point reference images (labeled as No. 4 in figure below) to confirm the image requirements and amount of capturing.
 - Check the point parameters (labeled as No. 6 in figure below) to see if the point requires QR code scanning or not. If **Scanning Required is Required**, then you should scan the QR code to check in before capturing point images.
 - Check diagnostic method of the point (labeled as No. 7 in figure below). If it is an auto-diagnosed point, it shows the diagnostic standard. If it is a manual diagnosed point, it shows diagnosis options.





Figure 6-2 Route Inspection Work Flow

No.	Descriptions
1	Inspection task name.
2	Inspect point list. Press Δ and ∇ to select an inspect point and check the point details.
3	Display inspect point details.
4	Point reference images. They show the parts and angles of targets required for inspection. Capture inspection images as the reference images show. There may be several parts or angles should be inspected. Tap the left and right arrow (labeled as No. 8 in figure above) to browse all reference images.
5	Tap to browse saved inspection captures. Tap the left and right arrow (labeled as No. 8 in figure above) to switch captured images.
6	Tap to check the parameters of the selected point.



No.	Descriptions
7	Check diagnostic information of the point.
8	Tap to switch images.

5. Inspect one point.

- 1) Press  and return to live view.
- 2) Optional: Move to an inspect point and press  to switch to the optical channel.
- 3) Aim the lens to the QR code to scan.
- 4) Press  to capture inspect point images one by one according to the reference images until all required parts and angles of the point are captured.
- 5) After capturing the last required image, mark the diagnosis result.



For auto-diagnosed points, device marks the result according to the predefined diagnosis standards. For points that need manual diagnosis, choose a result option after last capture.

6. After inspection of one point, device switches to the next point automatically. Press  and  to switch points.

7. Repeat above steps to complete inspection and diagnosis of all points.

A completed task has  shown before the task name in the list.

What to do next

- You can delete inspection tasks by selecting a task and tapping .
- Upload the results to the PC client after finishing the route inspection. See the user manual of HIKMICRO Inspector for instructions.

6.3 Upload Inspection Result and View Report

Upload the inspection results to the client software for central management and report generation.

Before You Start

Connect your device with the PC that has the client software installed. See the step of device connection in *Create Inspection Route and Send Task to Device* for instructions.

1. Open HIKMICRO Inspector.
2. Click  and **Task Management** and check desired tasks.
3. Click **Read Inspection Result** to download the results from the device.

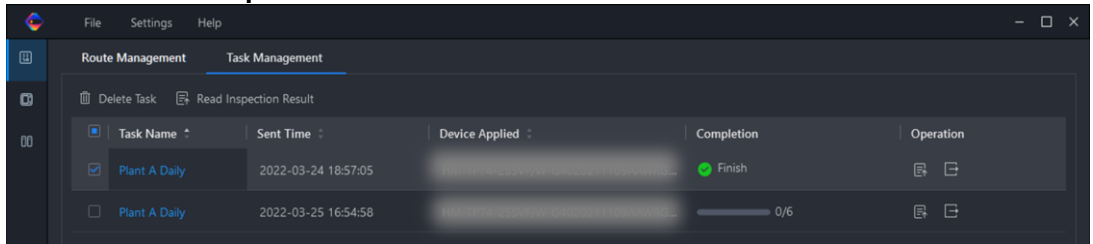

Figure 6-3 Task Management

The task status is shown in **Completion**.

4. Click on a finished task name to show result details.

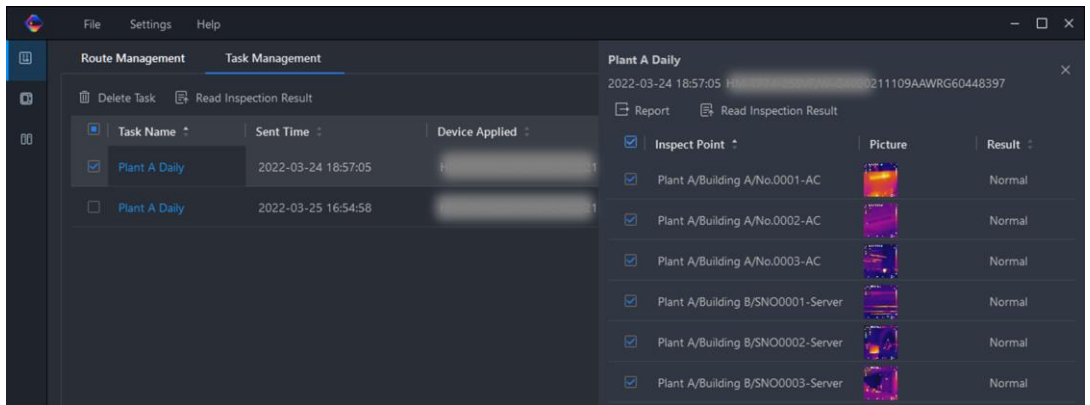



Figure 6-4 Inspection Results

5. Optional: Check a task or the desired inspect points and click **Report** for further analysis and report generation in HIKMICRO Analyzer.



- HIKMICRO Analyzer should be installed in your PC. Download the program from <https://www.hikmicrotech.com/en/industrial-products/hikmicro-analyzer-software/>.
- For the operations instructions in HIKMICRO Analyzer, tap  to get the user manual.
- Please keep HIKMICRO Analyzer up-to-date for the best compatibility and user experience.

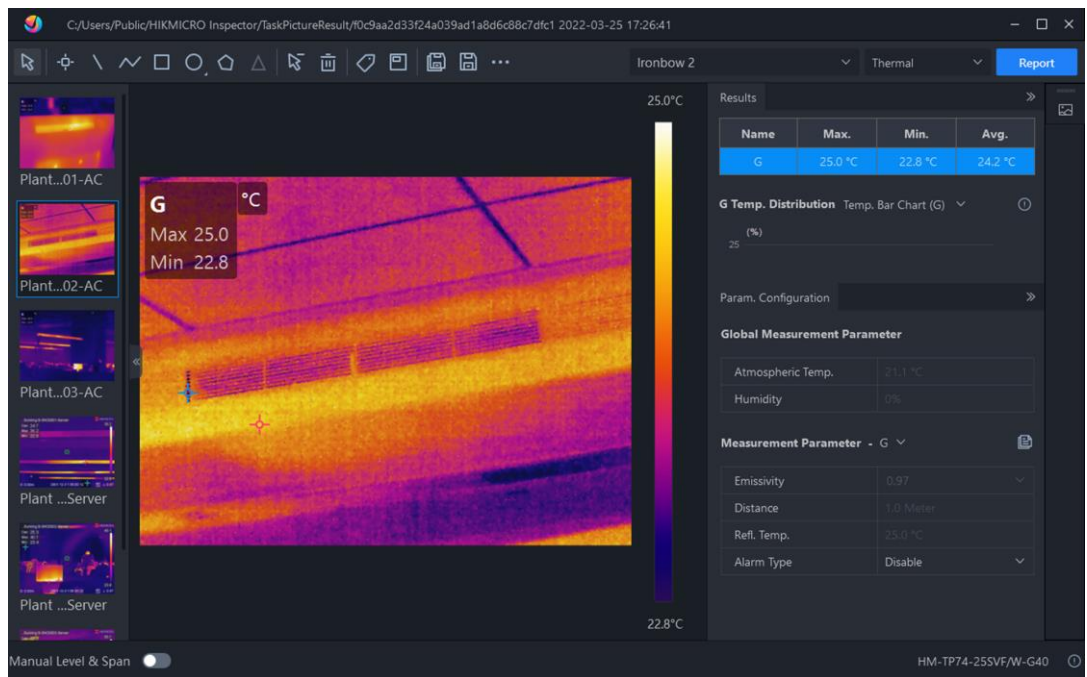

Figure 6-5 Analysis in HIKMICRO Analyzer

7 Picture and Video

Insert memory card into the device, then you can record videos, capture snapshots, and mark and save important data.



Device does not support capturing or recording when the menu is shown.

- When the device is connected to your PC, it does not support capturing or recording.
 - Go to **Settings > Capture Settings > Filename Header**, you can set the filename header for capturing or recording to distinguish the files recorded in a specify scene.
 - Go to **Settings > Device Settings > Device Initialization** to initialize the memory card as needed.
-

7.1 Capture Picture

Operate the device to capture live images and save the images in local albums.

Before You Start

- Make sure that there is a working memory card mounted in your device. See [Appearance](#) to locate the memory card slot of your device.
- Press  in live view interface to enable flashlight in dark environment.

1. Enter inspection mode to start.
2. Set a capture mode and press  in live view interface to capture images.



There are 2 modes available. Each mode requires different operations.

- 1) Select , and go to **Capture Settings > Capture Mode**.
- 2) Select a mode.

Table 7-1 Capture Modes

Capture Mode	Description
Capture One Image	Press  once to capture one image.
Scheduled Capture	Camera captures snapshots according to the set the interval and number for scheduled capture.

3. Press  to return to the live view interface.







4. Aim the lens at your target and press  or tap  to capture images



- Capture One Image mode, if **Edit before Saving** is NOT enabled (**Settings > Capture Settings**), the live image freezes and is saved in the default saving album. If **Edit before Saving** is enabled, the device enters the image editing interface.















Figure 7-1 Edit Image

Table 7-2 Editing Options



No.	Description
1	Text Note. 1. Tap to enter the editing page. 2. Tap on screen to input content and press  to save the settings.
2	Voice Note. 1. Select voice note and enter voice recording page. 2. Press OK or tap  to start recording. Press OK or tap  again to stop recording. 3. Optional: You can tap  to play the recording. If the voice note is unsatisfactory, tap  to delete it. Repeat above steps to record again. 4. Press  to exit.

No.	Description
3	<p>QR Code Note. Scan QR code to add information:</p> <ol style="list-style-type: none">1. Tap QR Code Note and the device enters the scanning mode.2. Aim the scanning frame at a QR code. Device reads the code and save the code information.3. Optional: Input the QR code.4. Press OK or tap the screen outside the scanning frame and Scan Asset ID interface will pop up.5. Input the QR code message.6. Tap <input checked="" type="checkbox"/> to confirm the settings.
4	<p>Tag Note. Set Tag Note to add text for captured pictures. It is a prerequisite to import a template first. Please see 7.4.4 for more details.</p> <ol style="list-style-type: none">1. Select Tag Note.2. Select a tag and enter the tag settings.3. Select at least 1 tag, and press OK to save the settings.4. Optional: Press  or  button to switch between different tags, and press OK to save the settings.

No.	Description
5	<p>Picture Note. Add visual image notes for captured radiometric images:</p> <ol style="list-style-type: none"> 1. Tap  in live view to enter Capture Settings. 2. Switch on Edit before Saving. 3. Press  button or Tap  in the shortcut bar in live view to capture snapshots. An image edition bar will pop up after the captured image freezes. 4. Tap  to enter Picture Note interface. 5. Press  button behind the device to add picture notes. 6. Press OK to save captured visual images to the local album. 7. Repeat step 5 and step 6 to add the next picture note. 8. Optional: Press  on screen to save one captured visual image to the local album, and go back to image edition interface. <hr/> <div style="display: flex; align-items: center;">  <p>The number of visual images will be displayed on the top of the Picture Note interface during taking the pictures, eg."1/3". No more than 3 pictures are supported.</p> </div> <hr/> <ol style="list-style-type: none"> 9. Tap  to save and exit.
6	<p>Editing thermal parameters.</p> <ul style="list-style-type: none"> ● Modify the image display mode, measurement parameters and tools, palettes, and level & span modes. ● Optional: If you need a PDF report of the file, tap  on the upper right corner of the screen. Input Report Name and Thermographer, and tap  to generate the report. <hr/> <div style="display: flex; align-items: center;">  <p>Generated reports are saved under the same path of the memory card as the image files. The PDF reports cannot be viewed on local device. Export and read reports on computers. See <i>Export Files</i> for instructions.</p> </div> <hr/> <p>When finishing all operations, tap  to save the change and exit the editing interface.</p>
7	<p>After all information added to the image, select Save to exit.</p>

- Scheduled Capture: A counter display in top of the screen showing the completed amount of capturing.
- Optional: You can set more capture settings as demanded.

Table 7-3 More Optional Capture Settings

Objective	Settings
Save an additional visual image together with the thermal image.	<p>Select , and go to Capture Settings. Enable Save Visual Image and set Visual Image Resolution.</p> <p> Note If the targets are in poor light condition, enable Flashlight. The device turns on the flashlight when capturing images.</p>
View clear thermal image on high resolution screen.	<p>Select , and go to Capture Settings. Enable SuperIR before capturing. Resolution of captured thermal images with SuperIR is about 4 times as the original one.</p>

What to do next

- Press  to enter albums to view and manage files and albums. See *Manage Albums* and *Manage Files* for operation instructions.
- You can connect your device to PC to export local files in albums for further use. See *Export Files*.
- You can edit the saved images. See *Edit Images*.

7.2 Record Video

Before You Start

- A memory card should be mounted for video storage.
- Press  in live view interface to enable the flashlight in dark environment if you want to record an optical video.

1. Select , and go to **Capture Settings > Video Type** to set the video format.



Video type configuration is supported by certain models of this series. MP4 video type is adopted for the models of no such configuration option.

Radiometric Video

Raw thermal data is attached in videos saved in .hrv formats. They can only be played and further analyzed with HIKMICRO Analyzer.



When the storage space is smaller than 500 MB, radiometric video recording is not allowed. Accidentally stopped recordings are not saved.

MP4

Recorded videos are saved in .mp4 format. These video clips can be played on local device, and any players that support this format (HIKMICRO Analyzer does not support playing this video format.).

2. **Optional:** Set frame rate for the selected video type.
 - 1) Enable **Frame Rate Configuration**.
 - 2) Enter **Video Type** again, and there will be frame rate options appearing under the selected video type.
 - 3) Select **Frame Rate** and scroll to set a desired value.



Higher frame rate offers a smoother video with more details for watching especially when motion occurs. But higher frame rate also means bigger video size which consumes more storage space.



- 4) Press **OK**.
3. In the live view interface, hold  button or tap  in the shortcut bar to start recording. The recording signs display on the top center of the interface.

The recording signs for radiometric video and MP4 videos are different.

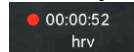
When you see , it is recording a MP4 video. When you see



, it is recording a radiometric video.

4. When you finish, press **OK**/ buttons or tap  in the shortcut bar to stop recording. The recording video will be saved automatically and exit.



You can also press **OK** or  to stop recording.

What to do next

Check the saved videos from  in menu mode. See [View and Manage Local Files](#) for more information.

7.3 Filename Header and File Naming



It is available to set the rules for file naming before picture capture and video recording. Tap  > **Capture Settings** to set filename header and select file naming modes.

Table 7-4 File Naming Rules

Elements	Description
Filename Header	Set the prefix for files of captured pictures and videos. Input the header and tap  to confirm the settings.
File Naming	<p>Time Stamp and Numbering modes are supported. Time Stamp consists “filename header”, “date and time” and “file format”.</p> <hr/> <p> When the file naming is Numbering, the maximum number of saved files is 99,999.</p> <p>You need to delete some images before saving new ones if saved files is beyond 99,999.</p>

7.4 View and Manage Local Files

Device captured images and videos are saved in local albums. You can create, delete, rename and set an album as the default saving album. For files, operations, such as browsing, moving and deleting, are available.



1. Press  to enter **Albums**.
2. To create, rename, delete and set an album as the default saving album, see [Manage Albums](#) for instructions.
3. For file operations, such as, moving or deleting a file, see [Manage Files](#) for instructions.
4. Press  to exit.

Table 7-5 File Type and Description

File Type	Format	Description
MP4 Videos	File Name.mp4	Playing, moving and deleting video files are supported on device.
Radiometric Videos	File Name.hrv	File of this format cannot be played on your device. The file extension is determined by the frame rate of a video. Use HIKMICRO Analyzer to play and analyze the file. Please upgrade the software to the latest version, otherwise the .hrv file may not be supported.
Radiometric Images	File Name.jpeg	Editing text and voice notes, moving files, checking basic information, modifying thermal parameters, and deleting files are supported on device.

7.4.1 Manage Albums















You can create several albums to manage captured images and video files on your device. Newly captured images and videos are saved in the **Default Saving Album** .

Table 7-6 Albums Management



Task	Operations
Create a New Album	<ol style="list-style-type: none"> 1. Press  to enter Albums. 2. Tap  to add a new album. 3. A soft keyboard is displayed, where you can enter the name of the album by touching the screen. 4. Tap  to finish. <hr/>  <p>The newly created album becomes the default saving album and appears at the top of the album list.</p>
Rename an Album	<ol style="list-style-type: none"> 1. Press  to enter Albums. 2. Select the album to rename. 3. Tap , and select Rename. A soft keyboard is displayed.









Task	Operations
	<p>4. Tap  to delete the old name, and enter the new name for the album by touching the screen.</p> <p>5. Tap  to finish.</p>
Change the Default Saving Album	<p>1. Press  to enter Albums.</p> <p>2. Select the album you want to use as the default saving album.</p> <p>3. Tap , and select Set as Default Saving Album.</p> <hr/> <p></p> <p>The default saving album appears at the top of the album list.</p>
Delete an Album	<p>1. Press  to enter Albums.</p> <p>2. Select the album you want to delete.</p> <p>3. Tap , and select Delete. A prompt box appears on the interface.</p> <p>4. Tap OK to delete the album.</p> <hr/> <p></p> <p>The files in an album are deleted as well when deleting the album. Move the files to other albums if they are still needed. See <i>Manage Files</i> for instructions.</p>

7.4.2 Manage Files



You can delete the recorded files and move the files to other albums on the device.

Table 7-7 Files Management

Task	Operations
Delete a File	<p>1. Press  to enter Albums.</p> <p>2. Tap to select the album storing the file to be deleted.</p> <p>3. In the album, tap to select the file to be deleted.</p> <p>4. Tap , and select Delete. A prompt box appears on the interface.</p> <p>5 Tap OK to delete the file.</p>
Delete Multiple Files	<p>1. Press  to enter Albums.</p>

Task	Operations
	<ol style="list-style-type: none"> 2. Tap to select the album storing the files to be deleted. 3. In the album, tap , and tap the files to be deleted. 4. Tap . A prompt box appears on the interface. 5 Tap OK to delete the files. <hr/> <div style="display: flex; align-items: center;">  <p>You can also delete a single file in this way.</p> </div>
Move a File	<ol style="list-style-type: none"> 1. Press  to enter Albums. 2. Tap to select the album storing the file to be moved. 3. In the album, tap to select the file to be moved. 4. Tap ..., and select Move. The album list is displayed. 5 Tap to select the album to move to.
Move Multiple Files	<ol style="list-style-type: none"> 1. Press  to enter Albums. 2. Tap to select the album storing the files to be moved. 3. In the album, tap , to select the files to be moved. 4. Tap . The album list is displayed. 5. Tap to select the album to move to. <hr/> <div style="display: flex; align-items: center;">  <p>You can also move a single file in this way.</p> </div>



Tap  to select all files, and tap  to deselect files.

7.4.3

Edit Images

Editing the notes saved with the images, and changing the thermal parameters are allowed on your thermal camera.

In live view, press  to enter albums.

1. Tap to open an album.
2. Tap to open an image file and tap on the image to call the editing menu.



Figure 7-2 Edit Image

3. Select an option and complete corresponding operations.

Table 7-8 Image Editing Description

No.	Description
1	Editing text note. Add a new text note or change the existed note, and press <input checked="" type="checkbox"/> to save the settings.
2	Editing voice note. You can add a new voice note, play or delete an existed voice note. If the file already has a voice note, tap to play or delete the note. If the file has no voice note attached, press OK or tap
3	Editing QR code note. Add a new Asset ID or change the existed Asset ID, and press <input checked="" type="checkbox"/> to save the settings.
4	Add visual picture note for the captured images. Please see Table 7-2 for more details.
5	Add Tag Note, namely the standard text, to captured images. It is necessary to import a template first. Please see 7.4.4 for more details.
6	File Details. Show basic information of the file, for example, the saving time, the last modified time, resolution, distance, emissivity, relative humidity, reflection temperature of the file.
7	Editing thermal parameters of the image. Modify the image display mode, measurement parameters and tools, palettes, and level & span modes. Optional: If you need a PDF report of the file, tap on the upper right corner of the screen. Input Report Name and Thermographer , and tap <input checked="" type="checkbox"/> to generate the report. <hr/> <ul style="list-style-type: none"> Generated reports are saved under the same path of the memory card as the image files. The PDF reports can not be

No.	Description
	viewed on local device. Export and read reports on computers. See <i>Export Files</i> for instructions. <ul style="list-style-type: none">● When finishing all operations, tap  to save the change and exit the editing interface.
8	Delete, move or transmit the file.

7.4.4 Import and Manage Tag Note Templates

Tag note templates contains the predefined tag name and options. With the template imported and activated, users can quick add tags to captured snapshots.

Tag note templates are generated on the client software HIKMICRO Analyzer. Copy the templates of json format to the storage of your device, then you can use and manage the templates.

1. Generate tag note templates on HIKMICRO Analyzer.



- Download HIKMICRO Analyzer client software from our website www.hikmicrotech.com or contact our technical support team for help.
- Click on  at the upper right corner of the software window to get operation guide.
- Software generated templates are saved in the path of PC: Public\HIKMICRO Analyzer\TextRemarkTemplate.

2. Connect your camera to PC by the supplied cable. Copy and paste the template files to the TextNote folder of the device storage.



If more than one templates are imported, the last edited template is the active one by default. Up to 10 templates can be imported.

3. Go to **Settings > Capture Settings > Tag Note Template** to manage templates.
 - 1) Select a template.
 - 2) Tap on  at the upper right corner of screen.
 - 3) Set the template as the default template or delete the template.

7.5 Export Files

7.5.1 Export Files to PC

Connect the device to your PC with a supplied cable, you can export the recorded videos, captured snapshots, and PDF reports.

1. Connect the device to your PC with a USB cable.
2. Select **USB Drive** mode in the pop-up window on the device.  will be displayed in the device status bar, and a notice for detecting a removable disk will pop up on your PC.
3. Open the detected disk, and select and copy the videos or snapshots to your PC.
4. Disconnect the device from your PC.

What to do next

You can import the captured snapshots to HIKMICRO Analyzer for further data analysis. See the *User Manual of HIKMICRO Analyzer* for the operation guide.

7.5.2 Export Files to HIKMICRO Viewer

Connect the device to HIKMICRO Viewer application on the phone, you can export the recorded videos, captured snapshots, and PDF reports.



For QR code download of HIKMICRO Viewer and the connection between the device and the application, please see [11.1](#), [11.2](#) for more details.

-
1. Connect the device to HIKMICRO Viewer.
 2. Tap **On-Device Files** in the home screen of HIKMICRO Viewer to select videos and snapshots.





When the device is connected via USB cable, it does NOT support On-Device Files viewing. Please disconnect the device at first.

-
3. Tap  to export the files to the **Albums** of HIKMICRO Viewer.



You can follow one of the paths to **Albums**:

- Tap  in the home screen of HIKMICRO Viewer to the Albums.
- Tap the thumbnail image on the lower left corner in Live View interface of HIKMICRO Viewer, and tap  on the upper right corner to the Albums.

-
4. **Optional 1:** Share files with the third party. Select the videos and snapshots and tap  to the third party.



Offline file sharing is NOT supported.

-
5. **Optional 2:** Save snapshots to your phone when you take a snapshot. Tap **Settings > General > Save Pictures to Phone.**



Videos is NOT supported to save to your phone.

7.5.3 Export Files via Bluetooth

It is available to export snapshots in the device **Albums** to the local album of your phone after the Bluetooth connection.



ONLY mobile phones with Android system are supported to receive images from the device via Bluetooth connection.





-
1. Turn on your phone Bluetooth.
 2. Turn on the device Bluetooth. Select , and go to **Connections > Bluetooth** to enable the device Bluetooth.
 3. Refresh the available Bluetooth list on the device, and pair the device Bluetooth with your phone Bluetooth.



- You can also press  or **OK** to quit pairing.
- When pairing successfully, "Paired" is displayed on the Available Devices list of the device, and "Connected" on the phone.

-
4. Send snapshots in the device **Albums** to your phone.
 - Send only one snapshot:
 - 1) Tap the required snapshot, and enter to the detailed page.
 - 2) Tap on any part of the screen to call the menu.

Handheld Thermography Camera User Manual

- 3) Tap  > , and choose the paired phone Bluetooth.
 - 4) Tap OK to confirm the settings.
- Send no more than 16 snapshots:
 - 1) Tap  to select more than one snapshots.
 - 2) Tap  to select a Bluetooth device.
 - 3) Choose the paired phone Bluetooth.
 - 4) Tap OK to confirm the settings.
-





- Videos are NOT supported to send to the phone via Bluetooth.
 - Tap  in the upper right corner to refresh the available Bluetooth list.
-

8 Distance Detection

The laser range finder consists of a laser transmitter and a laser receiver. The device detects the distance to a target by measuring the time it takes for a laser pulse to reach the target and return to the laser receiver. This time is converted to a distance, which is displayed on the screen.

Before You Start

- It is recommended to use this function in non-glare environment, such as indoor environment.
- It is recommended that the target has good light reflection, such as white paper and cable.



1. Select , and go to Device Settings > Display Settings.
2. Enable Distance.
3. Press  to save and exit.
4. In the live view interface, aim the cursor at the target and hold the laser button.
5. Release the laser button to finish distance measurement.

Result

The distance displays on the left status bar of screen.

9 Geographic Location Display

Equipped with satellite positioning modules, the device is able to display its longitude and latitude on the live image and in the captured images.

1. Select , and go to **Device Settings > GPS**.
2. Tap  to enable the GPS function. The device will prompt the GPS positioning result.

Result

You can see the location displayed at the left status bar of the screen.



- The satellite module is not able to receive signals when the device is indoor. Place the device in an empty outdoor space to receive signals.
 - In an outdoor space, wait for a moment for the device to display its location.
 - The location information is also attached in captured radiometric images. You can read the location by HIKMICRO Analyzer.
 - Location display is only supported by models with satellite positioning modules.
-

10 Direction Display

Equipped with a compass, the device is able to display its direction on the live image and in the captured images.



The function is supported by certain models.

Select , and go to **Device Settings > Compass** to enable the compass modules, then follow the pop-up instructions to calibrate the compass. See ***Calibrate Compass*** for more information.

After successful calibration, you can see the direction displayed at lower right corner of the screen. It is recommended to read the direction when you lay the device horizontally.

To increase the direction accuracy, you can set the magnetic declination correction. See ***Magnetic Declination Correction*** for instructions.





The direction information is also attached in captured radiometric images. You can read the direction by HIKMICRO Analyzer.

10.1 Calibrate Compass

Compass calibration is a must for correction direction display.

You need to calibrate the compass when you enable the function for the first time.

1. Call the calibration guide by the following ways.
 - Select , and go to **Device Settings > Compass** to turn the function off and on again.
 - Tap  in the swipe-down menu to quickly turn on/off the compass.
2. When you enable compass for the first time, or the compass is magnetically interfered, compass calibration guide pops up. Follow the screen instructions to move and rotate the device.

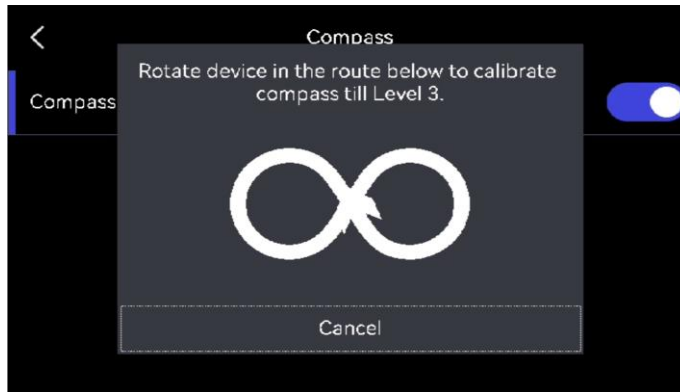



Figure 10-1 Calibrate Compass



- During calibration, keep moving and rotating the device to make sure that the device faces every possible direction.
- **Calibration Level** indicates the validity of calibration, higher level means more accurate compass reading. Calibration succeeds when the status bar in the live view interface shows, and **Calibrated Level** turns to 3.

3. Stop rotating the device when calibration success message pops up.

Result

The status bar in the live view interface shows  after successful calibration. If the number in this icon is smaller than 3, it means that the compass is not properly calibrated and the direction displayed might not be correct.

10.2 Magnetic Declination Correction

Magnetic declination is the angle variation between magnetic north and true north. Adding the magnetic declination to the compass increase the accuracy of direction reading.

Go to **Local Settings > Device Settings > Compass > Magnetic Declination Correction** to add the declination of device location.

11 Add Device to Software Clients

When connected to certain applications or software clients on the mobile phone or computer, the device supports live view browsing, video recording and snapshot capturing, route inspection, thermal image analysis and etc.

Table 11-1 Device and software client Connections

Terminals	Software Clients	Description
Mobile Phone	HIKMICRO Viewer	Connect the device to Viewer via hotspot or Wi-Fi, performing live view browsing and function settings like snapshot capturing or video recording.
Computer	HIKMICRO Inspector	Connect the device to the network that Inspector is in, then Inspector can send inspection tasks to the device.
Computer	HIKMICRO Analyzer	Connect the device to Analyzer via a USB cable, achieving live view castscreen, snapshot capturing or video recording on Analyzer.

11.1 Connect Device to HIKMICRO Viewer via Wi-Fi

Before You Start



Scan the QR code below to download and install HIKMICRO Viewer on your phone.



Android



iOS

1. Select  and go to **Connections > WLAN** to enable Wi-Fi, and the searched Wi-Fi will be listed.
2. Connect your device to a Wi-Fi network.
 - 1) Select Wi-Fi to connect to and a soft keyboard is displayed.
 - 2) Enter the password.
 - 3) Tap  to save the settings.
3. Connect your phone to the Wi-Fi network that the device is in.
4. Open HIKMICRO Viewer, and tap **+ > Add Device > Connect** to add the device.
5. Optional: Scan QR code on the device with HIKMICRO Viewer.
 - 1) Connect your phone to the Wi-Fi network that the device is in
 - 2) Tap  on the WLAN interface, and a QR code will pop up.
 - 3) Launch HIKMICRO Viewer to tap **+ > Scan QR Code**
 - 4) Scan the QR code on the device with HIKMICRO Viewer.
 - 5) Tap **Join** in the pop-up window on your phone to confirm the settings.

11.2 Connect Device to HIKMICRO Viewer via Hotspot

Before You Start



Scan the QR code below to download and install HIKMICRO Viewer on your phone.



Android



iOS





1. Select  and go to **Connections > Hotspot** to turn on the device hotspot.
2. Set password for the hotspot.
 - 1) Tap **Set Password**, and input the password for the hotspot.
 - 2) Tap  to finish.

3. Enable the Wi-Fi function of mobile phone and search the device hotspot to join.
4. Open HIKMICRO Viewer, and tap **+** > **Add Device** > **Connect** to add the device.
5. Optional: Scan QR code of the device hotspot with HIKMICRO Viewer.
 - 1) Turn on the device hotspot, and a QR code will pop up.
 - 2) Launch HIKMICRO Viewer to tap **+** > **Scan QR Code**.
 - 3) Aim the phone camera at the QR code of the device hotspot.
 - 4) Tap **Join** > **Connect** in the pop-up window on your phone to confirm the settings.

11.3 Connect Device to HIKMICRO Inspector

Before You Start

Download and install HIKMICRO Viewer on your PC. Please visit our website www.hikmicrotech.com to download the installation package.

1. Connect your device and PC to the same LAN. Available methods as below:
 - Connect your PC and the device to the same Wi-Fi network.
 - 1) Tap  > **Connections** > **WLAN** to enable the device Wi-Fi.
 - 2) Select Wi-Fi to connect to and enter the password.
 - 3) Tap  to save the settings.
 - 4) Connect your PC to the Wi-Fi network that the device is in.
 - Connect your PC to the device hotspot.
 - 1) Tap  > **Connections** > **Hotspot** to turn on the device hotspot.
 - 2) Set password for the hotspot.
 - Tap **Set Password**, and input the password for the hotspot.
 - Tap  to finish.
 - 3) Refresh PC WLAN list, and search the device hotspot to join.
2. Launch HIKMICRO Inspector, and click  to add the device.
 - Manually Add: Click **Add** and input IP address in the pop-up window.
 - Automatically Add: Click **Online Device**, and available online devices will be displayed.

11.4 Cast Screen on HIKMICRO Analyzer

The device supports casting screen to HIKMICRO Analyzer PC client. You can connect the device to your PC via a Type-C cable, and cast the real-time live view of the device to your PC, and perform video recording or snapshots via Analyzer.



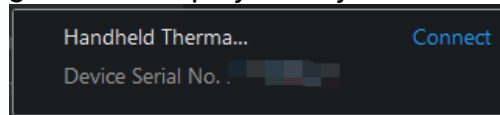

Live view function is ONLY supported in HIKMICRO Analyzer v1.7.0 and the newer versions. Please download or update to v1.7.0 and the newer versions.

1. Download and open HIKMICRO Analyzer on your PC. Please visit our website www.hikmicrotech.com or contact technical support or customer service teams for installation packages.
2. Connect the device with your PC via a supplied Type-C cable.
3. Select **USB Cast Screen** on the pop-up USB Mode interface of the device.  will be displayed on the upper left corner on the device status bar.
4. Click **Refresh** in the Analyzer Live interface, and the reminder **New Device Detected** will appear.
5. Click **Connect** in the drop-down box in the Analyzer Live interface, and the real-time image will be displayed on your PC.



12 System Settings

12.1 Set LED Light

In live view mode, press  to enable/disable the LED light. Or tap  on the swipe-down menu.

12.2 Set Unit

Select , and go to **Device Settings** > **Unit** to set the temperature unit and distance unit.

12.3 HDMI Image Output



You can view the image on the display unit for details with this function.

If your device has a micro HDMI output interface, connect the device and a display unit to cast the image.



This function is only supported by the models with micro HDMI output interface.

12.4 Set Time and Date

1. Select , and go to **Local Settings** > **Device Settings** > **Time and Date**.
2. Set the date and time.
3. Press  to save and exit.



Go to **Display Settings** to enable or disable time and date display.

13 Maintenance

13.1 View Device Information

Select , and go to **Local Settings > Device Settings > Device Information** to view the device information.

13.2 Upgrade Device

13.2.1 Upgrade Device via PC

Before You Start

- Please download the upgrade file from the official website <http://www.hikmicrotech.com> or contact the custom service and technical support to get the upgrade file first.
 - Make sure that the device battery is fully charged.
 - Make sure that Auto Power-off function is turned-off to avoid accidental suspension during upgrading.
 - Make sure that a memory card has been installed to device.
1. Connect the device to your PC with cable.
 2. Select **USB Drive** on the pop-up **USB Mode** window of the device.  will be displayed on the device status bar, and a notice for detecting a removable disk will pop up in your PC.
 3. Click the disk on your PC to open it.
 4. Select and copy the upgrade file, and paste it to the root directory of the device.



Make sure that the upgrade file pasted to the root directory is extracted.

5. Disconnect the device from your PC.
6. Reboot the device and then it will upgrade automatically. The upgrading process will be displayed in the main interface.



After upgrading, the device reboots automatically. You can view the current version in **Device Settings > Device Information**.

13.2.2 Upgrade Device via HIKMICRO Viewer

Before You Start

Make sure that you have installed HIKMICRO Viewer on your phone. Please see [11.1 11.2](#) for installation.

1. Launch the client on your phone.
2. Upgrade the device. You can choose one of the following path:
 - In the home screen, tap **Device Upgrade > Check for Updates**.
 - In the home screen, tap **Device Info > Device Upgrade > Check for Updates**.

13.3 Restore Device

Select , and go to **Device Settings > Device Initialization > Restore Device** to initialize the device and restore default settings.

13.4 Initialize Memory Card

When a memory card is use on the handheld thermal camera for the first time, it needs to be initialized first.

Select , and go to **Device Settings > Device Initialization> Format Storage Card** to initialize the memory card.



If there are files in the memory card, make sure that the files have been backed up before memory card initialization. Once the card is initialized, data and files cannot be recovered.

13.5 Save Logs

Save device operation logs for quick troubleshooting. The logs are stored in memory card or built-in storage, and they are exported via PC.

1. Tap Settings > Device Settings.
2. Slide Save Logs to enable the logs collection function.
3. Select OK to confirm the settings.



- When you restart the device, tap Save Logs again to enable the function.
 - When you need to export the logs to our technical support team, open the disk on your PC to copy and paste the .tar files stored in the log folder in the root directory of the SD card. Please see [7.5](#) for exporting files.
-

13.6 About Calibration

Please contact the local dealer for the information on maintenance points. For more detailed calibration services, please refer to <https://www.hikmicrotech.com/en/support/calibration-service/>.

14 Appendix

14.1 FAQ

Scan the following QR code to get device common FAQ.



Legal Information

Legal Information

© Hangzhou Microimage Software Co., Ltd. All rights reserved.

About this Manual

The Manual includes instructions for using and managing the Product. Pictures, charts, images and all other information hereinafter are for description and explanation only. The information contained in the Manual is subject to change, without notice, due to firmware updates or other reasons. Please find the latest version of this Manual at the HIKMICRO website (www.hikmicrotech.com).

Please use this Manual with the guidance and assistance of professionals trained in supporting the Product.

Trademarks Acknowledgement

 **HIKMICRO** and other HIKMICRO's trademarks and logos are the properties of HIKMICRO in various jurisdictions.

Other trademarks and logos mentioned are the properties of their respective owners.

 **HDMI**™ The terms HDMI and HDMI High-Definition Multimedia Interface, and the HDMI Logo are trademarks or registered trademarks of HDMI Licensing Administrator, Inc. in the United States and other countries.

LEGAL DISCLAIMER

TO THE MAXIMUM EXTENT PERMITTED BY APPLICABLE LAW, THIS MANUAL AND THE PRODUCT DESCRIBED, WITH ITS HARDWARE, SOFTWARE AND FIRMWARE, ARE PROVIDED "AS IS" AND "WITH ALL FAULTS AND ERRORS". HIKMICRO MAKES NO WARRANTIES, EXPRESS OR IMPLIED, INCLUDING WITHOUT LIMITATION, MERCHANTABILITY, SATISFACTORY QUALITY, OR FITNESS FOR A PARTICULAR PURPOSE. THE USE OF THE PRODUCT BY YOU IS AT YOUR OWN RISK. IN NO EVENT WILL HIKMICRO BE LIABLE TO YOU FOR ANY SPECIAL, CONSEQUENTIAL, INCIDENTAL, OR INDIRECT DAMAGES, INCLUDING, AMONG OTHERS, DAMAGES FOR LOSS OF BUSINESS PROFITS, BUSINESS INTERRUPTION, OR LOSS OF DATA, CORRUPTION OF SYSTEMS, OR LOSS OF

DOCUMENTATION, WHETHER BASED ON BREACH OF CONTRACT, TORT (INCLUDING NEGLIGENCE), PRODUCT LIABILITY, OR OTHERWISE, IN CONNECTION WITH THE USE OF THE PRODUCT, EVEN IF HIKMICRO HAS BEEN ADVISED OF THE POSSIBILITY OF SUCH DAMAGES OR LOSS.

YOU ACKNOWLEDGE THAT THE NATURE OF THE INTERNET PROVIDES FOR INHERENT SECURITY RISKS, AND HIKMICRO SHALL NOT TAKE ANY RESPONSIBILITIES FOR ABNORMAL OPERATION, PRIVACY LEAKAGE OR OTHER DAMAGES RESULTING FROM CYBER-ATTACK, HACKER ATTACK, VIRUS INFECTION, OR OTHER INTERNET SECURITY RISKS; HOWEVER, HIKMICRO WILL PROVIDE TIMELY TECHNICAL SUPPORT IF REQUIRED.

YOU AGREE TO USE THIS PRODUCT IN COMPLIANCE WITH ALL APPLICABLE LAWS, AND YOU ARE SOLELY RESPONSIBLE FOR ENSURING THAT YOUR USE CONFORMS TO THE APPLICABLE LAW. ESPECIALLY, YOU ARE RESPONSIBLE, FOR USING THIS PRODUCT IN A MANNER THAT DOES NOT INFRINGE ON THE RIGHTS OF THIRD PARTIES, INCLUDING WITHOUT LIMITATION, RIGHTS OF PUBLICITY, INTELLECTUAL PROPERTY RIGHTS, OR DATA PROTECTION AND OTHER PRIVACY RIGHTS. YOU SHALL NOT USE THIS PRODUCT FOR ANY PROHIBITED END-USES, INCLUDING THE DEVELOPMENT OR PRODUCTION OF WEAPONS OF MASS DESTRUCTION, THE DEVELOPMENT OR PRODUCTION OF CHEMICAL OR BIOLOGICAL WEAPONS, ANY ACTIVITIES IN THE CONTEXT RELATED TO ANY NUCLEAR EXPLOSIVE OR UNSAFE NUCLEAR FUEL-CYCLE, OR IN SUPPORT OF HUMAN RIGHTS ABUSES.

IN THE EVENT OF ANY CONFLICTS BETWEEN THIS MANUAL AND THE APPLICABLE LAW, THE LATTER PREVAILS.

Regulatory Information

These clauses apply only to the products bearing the corresponding mark or information.

FCC Information

Please take attention that changes or modification not expressly approved by the party responsible for compliance could void the user's authority to operate the equipment.

This device complies with Part 15 of the FCC Rules. Operation is subject to the following two conditions:

- (1) This device may not cause harmful interference, and
- (2) This device must accept any interference received, including interference that may cause undesired operation.

This equipment complies with FCC radiation exposure limits set forth for an uncontrolled environment.

Note: This equipment has been tested and found to comply with the limits for a Class A digital device, pursuant to part 15 of the FCC Rules. These limits are designed to provide reasonable protection against harmful interference when the equipment is operated in a commercial environment. This equipment generates, uses, and can radiate radio frequency energy and, if not installed and used in accordance with the instruction manual, may cause harmful interference to radio communications. Operation of this equipment in a residential area is likely to cause harmful interference in which case the user will be required to correct the interference at his own expense.

INFORMATIONEN FÜR PRIVATE HAUSHALTE

- (1) Getrennte Erfassung von Altgeräten: Elektro- und Elektronikgeräte, die zu Abfall geworden sind, werden als Altgeräte bezeichnet. Besitzer von Altgeräten haben diese einer vom unsortierten Siedlungsabfall getrennten Erfassung zuzuführen. Altgeräte gehören insbesondere nicht in den Hausmüll, sondern in spezielle Sammel- und Rückgabesysteme.
- (2) Batterien und Akkus sowie Lampen: Besitzer von Altgeräten haben Altbatterien und Altakkumulatoren, die nicht vom Altgerät umschlossen sind, die zerstörungsfrei aus dem Altgerät entnommen werden können, im

Regelfall vor der Abgabe an einer Erfassungsstelle vom Altgerät zu trennen. Dies gilt nicht, soweit Altgeräte einer Vorbereitung zur Wiederverwendung unter Beteiligung eines öffentlich-rechtlichen Entsorgungsträgers zugeführt werden.

(3) Möglichkeiten der Rückgabe von Altgeräten: Besitzer von Altgeräten aus privaten Haushalten können diese bei den Sammelstellen der öffentlich-rechtlichen Entsorgungsträger oder bei den von Herstellern oder Vertreibern im Sinne des ElektroG eingerichteten Rücknahmestellen unentgeltlich abgeben. Rücknahmepflichtig sind Geschäfte mit einer Verkaufsfläche von mindestens 400 m² für Elektro- und Elektronikgeräte sowie diejenigen Lebensmittelgeschäfte mit einer Gesamtverkaufsfläche von mindestens 800 m², die mehrmals pro Jahr oder dauerhaft Elektro- und Elektronikgeräte anbieten und auf dem Markt bereitstellen. Dies gilt auch bei Vertrieb unter Verwendung von Fernkommunikationsmitteln, wenn die Lager- und Versandflächen für Elektro- und Elektronikgeräte mindestens 400 m² betragen oder die gesamten Lager- und Versandflächen mindestens 800 m² betragen. Vertreter haben die Rücknahme grundsätzlich durch geeignete Rückgabemöglichkeiten in zumutbarer Entfernung zum jeweiligen Endnutzer zu gewährleisten. Die Möglichkeit der unentgeltlichen Rückgabe eines Altgerätes besteht bei rücknahmepflichtigen Vertreibern unter anderem dann, wenn ein neues gleichartiges Gerät, das im Wesentlichen die gleichen Funktionen erfüllt, an einen Endnutzer abgegeben wird.

(4) Datenschutz-Hinweis: Altgeräte enthalten häufig sensible personenbezogene Daten. Dies gilt insbesondere für Geräte der Informations- und Telekommunikationstechnik wie Computer und Smartphones. Bitte beachten Sie in Ihrem eigenen Interesse, dass für die Löschung der Daten auf den zu entsorgenden Altgeräten jeder Endnutzer selbst verantwortlich ist.

(5) Bedeutung des Symbols „durchgestrichene Mülltonne“:



Das auf Elektro- und Elektronikgeräten regelmäßig abgebildete Symbol einer durchgestrichenen Mülltonne weist darauf hin, dass das jeweilige Gerät am Ende seiner Lebensdauer getrennt vom unsortierten Siedlungsabfall zu erfassen ist.

EU Conformity Statement



This product and - if applicable - the supplied accessories too are marked with "CE" and comply therefore with the applicable harmonized European standards listed under the Directive 2014/30/EU (EMCD), Directive 2014/35/EU (LVD), Directive 2011/65/EU (RoHS), Directive 2014/53/EU.

Hereby, Hangzhou Microimage Software Co., Ltd. declares that this device (refer to the label) is in compliance with Directive 2014/53/EU.

The full text of the EU declaration of conformity is available at the following internet address:

<https://www.hikmicrotech.com/en/support/download-center/declaration-of-conformity/>

Frequency Bands and Power (for CE)

The frequency bands and modes and transmitting power (radiated and/or conducted) nominal limits applicable to the following radio equipment are as follows:

Wi-Fi: 2.4 GHz (2.4 GHz to 2.4835 GHz): 20 dBm;

5 GHz (5.15 GHz to 5.25 GHz): 23 dBm;

5 GHz (5.725 GHz to 5.875 GHz): 14 dBm

5.15-5.25GHz indoors use.

Bluetooth: 2.4 GHz (2.4 GHz to 2.4835 GHz): 20 dBm

RF Exposure Information

This device has been tested and meets applicable limits for Radio Frequency (RF) exposure.

For the device without a supplied power adapter, use the power adapter provided by a qualified manufacturer. Refer to the product specification for detailed power requirements.

For the device without a supplied battery, use the battery provided by a qualified manufacturer. Refer to the product specification for detailed battery requirements.



Directive 2012/19/EU (WEEE Directive): Products marked with this symbol cannot be disposed of as unsorted municipal waste in the European Union. For proper recycling, return this product to your local supplier upon the purchase of equivalent new equipment, or dispose of it at designated collection points. For more information see: www.recyclethis.info.



Regulation (EU) 2023/1542 (Battery Regulation): This product contains a battery and it is in conformity with the Regulation (EU) 2023/1542. The battery cannot be disposed of as unsorted municipal waste in the European Union. See the product documentation for specific battery information. The battery is marked with this symbol, which may include lettering to indicate cadmium (Cd), or lead (Pb). For proper recycling, return the battery to your supplier or to a designated collection point. For more information see: www.recyclethis.info.



Warning: This is a class A product. In a domestic environment this product may cause radio interference in which case the user may be required to take adequate measures.

For the model SP120, please note that:

SP120H is a class B product. In a domestic environment this product may cause radio interference in which case the user may be required to take adequate measures.

Industry Canada ICES-003 Compliance

This device meets the CAN ICES-003 (A)/NMB-003(A) standards requirements.

For the model SP120, please note that:

This device meets the CAN ICES-003 (B) / NMB-003 (B) standards requirements.

This device complies with Industry Canada licence-exempt RSS standard(s). Operation is subject to the following two conditions:

- (1) this device may not cause interference, and
- (2) this device must accept any interference, including interference that may cause undesired operation of the device.

This equipment complies with IC RSS-102 radiation exposure limits set forth for an uncontrolled environment.

(i) The device for operation in the band 5150-5250 MHz is only for indoor use to reduce the potential for harmful interference to co-channel mobile satellite systems;

(ii) The maximum antenna gain permitted for devices in the band 5725-5875 MHz shall comply with the e.i.r.p. limits specified for point-to-point and non point-to-point operation as appropriate.

Users should also be advised that high-power radars are allocated as primary users (i.e. priority users) of the bands 5250-5350 MHz and 5650-5850 MHz and that these radars could cause interference and/or damage to LE-LAN devices.

Conformité Industrie Canada ICES-003

Cet appareil répond aux exigences des normes CAN ICES-003 (A)/NMB-003 (A).

Pour le modèle SP120, veuillez noter que:

Cet appareil répond aux exigences des normes CAN ICES-003 (B)/NMB-003 (B).

Le présent appareil est conforme aux CNR d'Industrie Canada applicables aux appareils radioexempts de licence. L'exploitation est autorisée aux deux conditions suivantes :

- (1) l'appareil ne doit pas produire de brouillage, et
- (2) l'utilisateur de l'appareil doit accepter tout brouillage radioélectrique subi, même si le brouillage est susceptible d'en compromettre le fonctionnement.

ce matériel est conforme aux limites de dose d'exposition aux rayonnements, CNR-102 énoncée dans un autre environnement.

(i) Les dispositifs fonctionnant dans la bande 5150-5250 MHz sont réservés uniquement pour une utilisation à l'intérieur afin de réduire les risques de brouillage préjudiciable aux systèmes de satellites mobiles utilisant les mêmes canaux.

(ii) Le gain d'antenne maximal autorisé pour les appareils dans la bande 5725-5875 MHz doivent respecter le pire limites spécifiées pour le point-à-point et l'exploitation non point à point, le cas échéant.

Les utilisateurs de radars de haute puissance sont désignés utilisateurs principaux (c.-à-d., qu'ils ont la priorité) pour les bandes 5250-5350 MHz et 5650-5850 MHz et que ces radars pourraient causer du brouillage et/ou des dommages aux dispositifs LAN-EL.

KC

A 급 기기: 이 기기는 업무용(A 급) 전자파적합기기로서 판매자 또는 사용자는 이 점을 주의하시기바라며, 가정 외의 지역에서 사용하는 것을 목적으로 합니다.



HIKMICRO

See the World in a New Way

Facebook: Hikmicro Industrial

Instagram: hikmicro_industrial

E-mail: support@hikmicrotech.com

LinkedIn: HIKMICRO

YouTube: HIKMICRO Industrial

Website: <https://www.hikmicrotech.com>

UD39645B