

# HM-Rings-2-H29

## Two-Piece Scope Rings

### Specification

GENERAL	
DIMENSION	48.5 mm × 21mm × 52.8 mm
WEIGHT	102 g
ACCESSORY	Wrench
INNER DIAMETER	30 mm
CENTER HEIGHT	29 mm

## Available Model

**HM-Rings-2-H29**

## Dimension

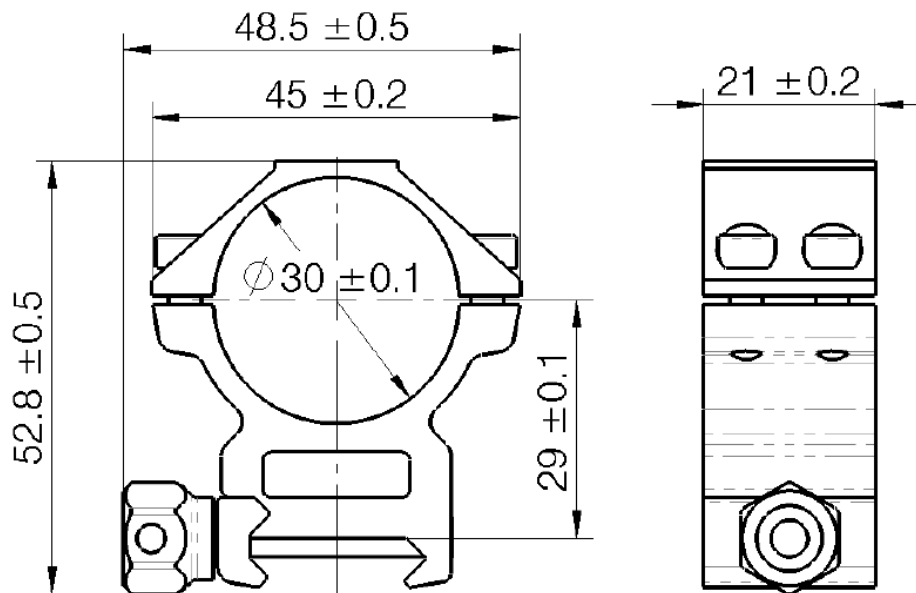

Unit: mm

COMPLIANCE NOTICE: The thermal series products might be subject to export controls in various countries or regions, including without limitation, the United States, European Union, United Kingdom and/or other member countries of the Wassenaar Arrangement. Please consult your professional legal or compliance expert or local government authorities for any necessary export license requirements if you intend to transfer, export, re-export the thermal series products between different countries.



 HIKMICRO Outdoor  hikmicro\_outdoor  HIKMICRO Outdoor  HIKMICRO  info@hikmicrotech.com  <http://hikmicrotech.com/en>

room 313, unit B, building 2, 399 danfeng road, xixing subdistrict, binjiang district, hangzhou, zhejiang  
@hangzhou microimage software co., Ltd .2020 | data subject to change without notice!