



# HM-ADAPTER-44A

## Adapter

The HM-ADAPTER-44A adapter connects the thermal clip-on and the daylight scope. It supports M52 × 0.75 mm thread, used for HIKMICRO THUNDER Clip-On 2.0.

### Specification

GENERAL	
DIMENSION	67 mm × 95 mm × 46.7 mm (2.64" × 3.74" × 1.84")
WEIGHT	80.4 g (0.18 lb)
MOUNTING DIAMETER	44 mm
THREAD	M52 × 0.75 mm
ACCESSORY	Hex Key, Ring

### Available Model

## HM-ADAPTER-44A

## Dimension

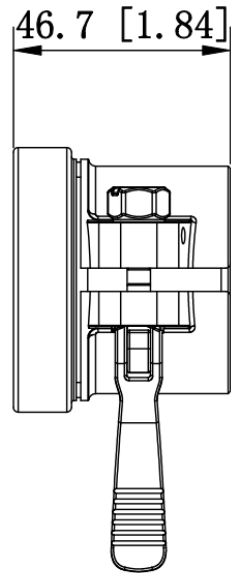
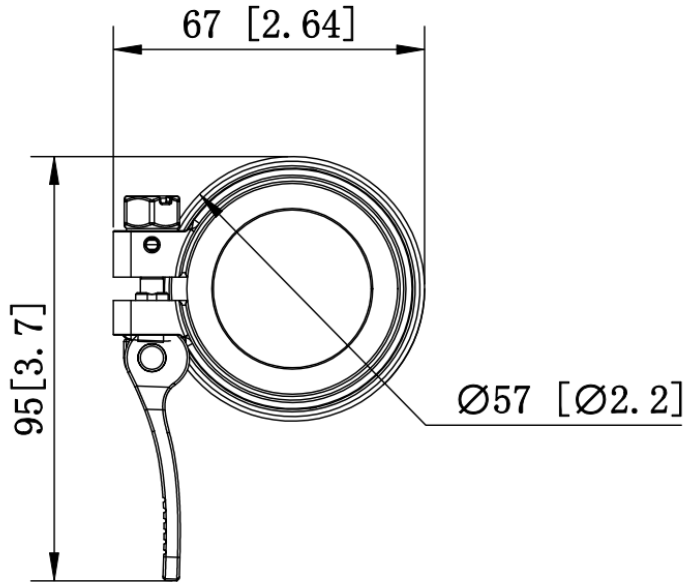

Unit:mm[Inch]



HIKMICRO SIGHT



HIKMICRO Outdoor hikmicro\_outdoor HIKMICRO Outdoor HIKMICRO info@hikmicrotech.com <http://hikmicrotech.com/en>

Room 313, Unit B, Building 2, 399 Danfeng Road, Xixing Subdistrict, Binjiang District, Hangzhou, Zhejiang  
@hangzhou microimage software co.,Ltd .2020 | data subject to change without notice!