



**HM-THUNDER-38A
Adapter**



The HM-THUNDER-38A adapter connects the thermal image Clip-On and the daylight scope.

▪ Specification

General

Dimension	89.33 mm × 64.2 mm × 50.6 mm (3.52 × 2.53 × 1.99 inch)
Weight	65 g
Accessory	Wrench, Plate, Ring
Mounting Diameter	38.1 mm to 43 mm (1.5~1.69 inch)

▪ Available Model

HM-THUNDER-38A

▪ Dimension

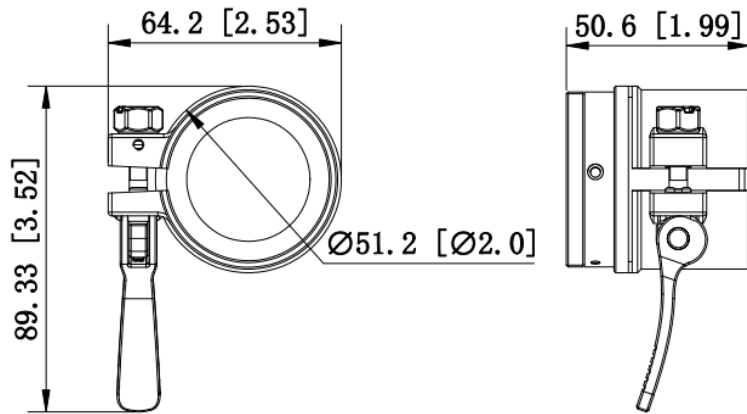

Unit: mm [inch]

▪ Accessory

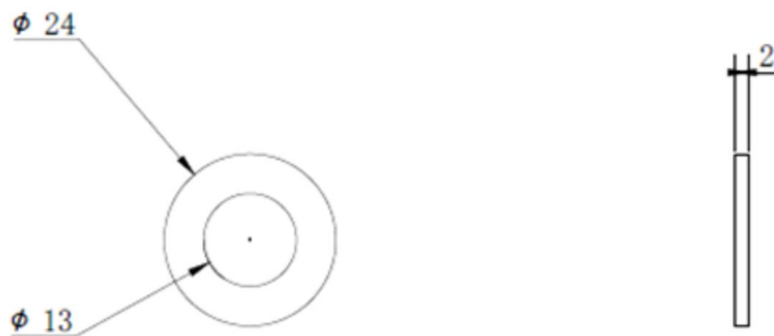
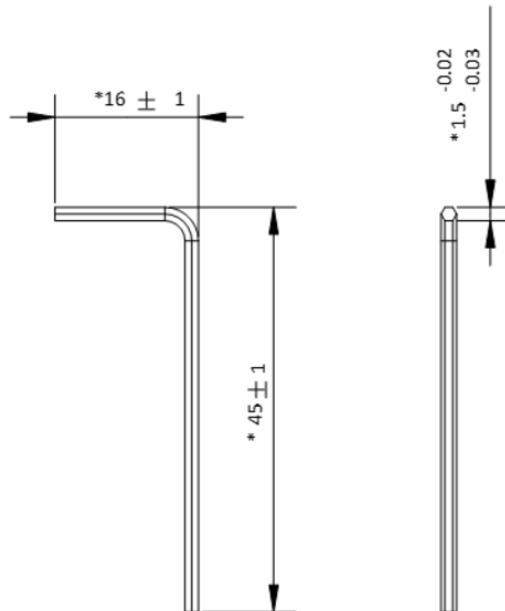

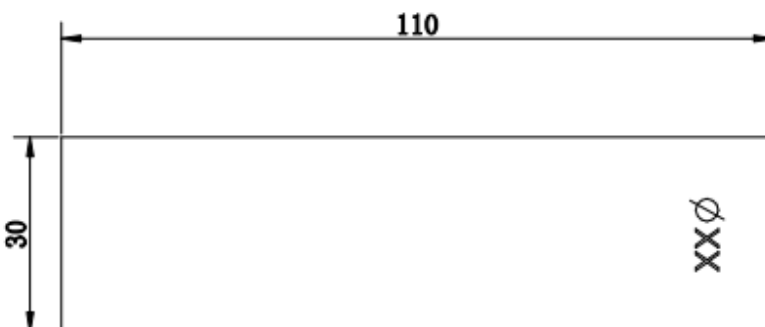

Unit: mm [inch]

COMPLIANCE NOTICE: The thermal series products might be subject to export controls in various countries or regions, including without limitation, the United States, European Union, United Kingdom and/or other member countries of the Wassenaar Arrangement. Please consult your professional legal or compliance expert or local government authorities for any necessary export license requirements if you intend to transfer, export, re-export the thermal series products between different countries.

