



Firefighting Thermal Camera

HIKMICRO FT Series

User Manual



Contact Us

Legal Information

©2023 Hangzhou Microimage Software Co., Ltd. All rights reserved.

About this Manual

The Manual includes instructions for using and managing the Product. Pictures, charts, images and all other information hereinafter are for description and explanation only. The information contained in the Manual is subject to change, without notice, due to firmware updates or other reasons. Please find the latest version of this Manual at the HIKMICRO website (www.hikmicrotech.com). Please use this Manual with the guidance and assistance of professionals trained in supporting the Product.

Trademarks

 HIKMICRO and other HIKMICRO's trademarks and logos are the properties of HIKMICRO in various jurisdictions.

Other trademarks and logos mentioned are the properties of their respective owners.

Disclaimer

TO THE MAXIMUM EXTENT PERMITTED BY APPLICABLE LAW, THIS MANUAL AND THE PRODUCT DESCRIBED, WITH ITS HARDWARE, SOFTWARE AND FIRMWARE, ARE PROVIDED "AS IS" AND "WITH ALL FAULTS AND ERRORS". HIKMICRO MAKES NO WARRANTIES, EXPRESS OR IMPLIED, INCLUDING WITHOUT LIMITATION, MERCHANTABILITY, SATISFACTORY QUALITY, OR FITNESS FOR A PARTICULAR PURPOSE. THE USE OF THE PRODUCT BY YOU IS AT YOUR OWN RISK. IN NO EVENT WILL HIKMICRO BE LIABLE TO YOU FOR ANY SPECIAL, CONSEQUENTIAL, INCIDENTAL, OR INDIRECT DAMAGES, INCLUDING, AMONG OTHERS, DAMAGES FOR LOSS OF BUSINESS PROFITS, BUSINESS INTERRUPTION, OR LOSS OF DATA, CORRUPTION OF SYSTEMS, OR LOSS OF DOCUMENTATION, WHETHER BASED ON BREACH OF CONTRACT, TORT (INCLUDING NEGLIGENCE), PRODUCT LIABILITY, OR OTHERWISE, IN

CONNECTION WITH THE USE OF THE PRODUCT, EVEN IF HIKMICRO HAS BEEN ADVISED OF THE POSSIBILITY OF SUCH DAMAGES OR LOSS.

YOU ACKNOWLEDGE THAT THE NATURE OF THE INTERNET PROVIDES FOR INHERENT SECURITY RISKS, AND HIKMICRO SHALL NOT TAKE ANY RESPONSIBILITIES FOR ABNORMAL OPERATION, PRIVACY LEAKAGE OR OTHER DAMAGES RESULTING FROM CYBER-ATTACK, HACKER ATTACK, VIRUS INFECTION, OR OTHER INTERNET SECURITY RISKS; HOWEVER, HIKMICRO WILL PROVIDE TIMELY TECHNICAL SUPPORT IF REQUIRED.

YOU AGREE TO USE THIS PRODUCT IN COMPLIANCE WITH ALL APPLICABLE LAWS, AND YOU ARE SOLELY RESPONSIBLE FOR ENSURING THAT YOUR USE CONFORMS TO THE APPLICABLE LAW. ESPECIALLY, YOU ARE RESPONSIBLE, FOR USING THIS PRODUCT IN A MANNER THAT DOES NOT INFRINGE ON THE RIGHTS OF THIRD PARTIES, INCLUDING WITHOUT LIMITATION, RIGHTS OF PUBLICITY, INTELLECTUAL PROPERTY RIGHTS, OR DATA PROTECTION AND OTHER PRIVACY RIGHTS. YOU SHALL NOT USE THIS PRODUCT FOR ANY PROHIBITED END-USES, INCLUDING THE DEVELOPMENT OR PRODUCTION OF WEAPONS OF MASS DESTRUCTION, THE DEVELOPMENT OR PRODUCTION OF CHEMICAL OR BIOLOGICAL WEAPONS, ANY ACTIVITIES IN THE CONTEXT RELATED TO ANY NUCLEAR EXPLOSIVE OR UNSAFE NUCLEAR FUEL-CYCLE, OR IN SUPPORT OF HUMAN RIGHTS ABUSES.

IN THE EVENT OF ANY CONFLICTS BETWEEN THIS MANUAL AND THE APPLICABLE LAW, THE LATTER PREVAILS.

Regulatory Information

These clauses apply only to the products bearing the corresponding mark or information.

EU Compliance Statement



This product and - if applicable - the supplied accessories too are marked with "CE" and comply therefore with the applicable harmonized European standards listed under the Directive 2014/30/EU (EMCD), Directive 2014/35/EU (LVD), Directive 2011/65/EU (RoHS).

Hereby, Hangzhou Microimage Software Co., Ltd. declares that this device (refer to the label) is in compliance with Directive 2014/53/EU.

The full text of the EU declaration of conformity is available at the following internet address:

<https://www.hikmicrotech.com/en/support/download-center/declaration-of-conformity/>

Frequency Bands and Power (for CE)

The frequency bands and transmitting power (radiated and/or conducted) nominal limits applicable to the following radio equipment are as follows:

Wi-Fi 2.4 GHz (2.4 GHz to 2.4835 GHz): 20 dBm

Bluetooth 2.4 GHz (2.4 GHz to 2.4835 GHz): 20 dBm

For the device without a supplied power adapter, use the power adapter provided by a qualified manufacturer. Refer to the product specification for detailed power requirements.

For the device without a supplied battery, use the battery provided by a qualified manufacturer. Refer to the product specification for detailed battery requirements.

Warning: This is a class A product. In a domestic environment this product may cause radio interference in which case the user may be required to take adequate measures.



Directive 2012/19/EU (WEEE Directive): Products marked with this symbol cannot be disposed of as unsorted municipal waste in the European Union. For proper recycling, return this product to your local supplier upon the purchase of equivalent new equipment, or dispose of it at designated collection points. For more information see: www.recyclethis.info.



Directive 2006/66/EC and its amendment 2013/56/EU (Battery Directive): This product contains a battery that cannot be disposed of as unsorted municipal waste in the European Union. See the product documentation for specific battery information. The battery is marked with this symbol, which may include lettering to indicate cadmium (Cd), lead (Pb), or mercury (Hg). For proper recycling, return the battery to your supplier or to a designated collection point. For more information see: www.recyclethis.info.

INFORMATIONEN FÜR PRIVATE HAUSHALTE

1. Getrennte Erfassung von Altgeräten:

Elektro- und Elektronikgeräte, die zu Abfall geworden sind, werden als Altgeräte bezeichnet. Besitzer von Altgeräten haben diese einer vom unsortierten Siedlungsabfall getrennten Erfassung zuzuführen. Altgeräte gehören insbesondere nicht in den Hausmüll, sondern in spezielle Sammel- und Rückgabesysteme.

2. Batterien und Akkus sowie Lampen:

Besitzer von Altgeräten haben Altbatterien und Altakkumulatoren, die nicht vom Altgerät umschlossen sind, die zerstörungsfrei aus dem Altgerät entnommen werden können, im Regelfall vor der Abgabe an einer Erfassungsstelle vom Altgerät zu trennen. Dies gilt nicht, soweit Altgeräte einer Vorbereitung zur Wiederverwendung unter Beteiligung eines öffentlich-rechtlichen Entsorgungsträgers zugeführt werden.

3. Möglichkeiten der Rückgabe von Altgeräten:

Besitzer von Altgeräten aus privaten Haushalten können diese bei den Sammelstellen der öffentlich-rechtlichen Entsorgungsträger oder bei den von Herstellern oder Vertreibern im Sinne des ElektroG eingerichteten Rücknahmestellen unentgeltlich abgeben. Rücknahmepflichtig sind Geschäfte mit einer Verkaufsfläche von mindestens 400 m² für Elektro- und Elektronikgeräte sowie diejenigen Lebensmittelgeschäfte mit einer Gesamtverkaufsfläche von mindestens 800 m², die mehrmals pro Jahr oder dauerhaft Elektro- und Elektronikgeräte anbieten und auf dem Markt bereitstellen. Dies gilt auch bei Vertrieb unter Verwendung von

Fernkommunikationsmitteln, wenn die Lager- und Versandflächen für Elektro- und Elektronikgeräte mindestens 400 m² betragen oder die gesamten Lager- und Versandflächen mindestens 800 m² betragen. Vertreiber haben die Rücknahme grundsätzlich durch geeignete Rückgabemöglichkeiten in zumutbarer Entfernung zum jeweiligen Endnutzer zu gewährleisten. Die Möglichkeit der unentgeltlichen Rückgabe eines Altgerätes besteht bei rücknahmepflichtigen Vertreibern unter anderem dann, wenn ein neues gleichartiges Gerät, das im Wesentlichen die gleichen Funktionen erfüllt, an einen Endnutzer abgegeben wird.

4. Datenschutz-Hinweis:

Altgeräte enthalten häufig sensible personenbezogene Daten. Dies gilt insbesondere für Geräte der Informations- und Telekommunikationstechnik wie Computer und Smartphones. Bitte beachten Sie in Ihrem eigenen Interesse, dass für die Löschung der Daten auf den zu entsorgenden Altgeräten jeder Endnutzer selbst verantwortlich ist.



5. Bedeutung des Symbols „durchgestrichene Mülltonne“:



Das auf Elektro- und Elektronikgeräten regelmäßig abgebildete Symbol einer durchgestrichenen Mülltonne weist darauf hin, dass das jeweilige Gerät am Ende seiner Lebensdauer getrennt vom unsortierten Siedlungsabfall zu erfassen ist.

Symbol Conventions

The symbols that may be found in this document are defined as follows.

Symbol	Description
 Note	Provides additional information to emphasize or supplement important points of the main text.
 Caution	Indicates a potentially hazardous situation, which if not avoided, could result in equipment damage, data loss, performance degradation, or unexpected results.
 Danger	Indicates a hazard with a high level of risk, which if not avoided, will result in death or serious injury.

Safety Instructions

Please read all the safety information carefully before using. These instructions are intended to ensure that user can use the product correctly to avoid danger or property loss.

Laws and Regulations

Use of the product must be in strict compliance with the local electrical safety regulations.

Transportation

- Keep the device in original or similar packaging while transporting it.
- Keep all wrappers after unpacking them for future use. In case of any failure occurred, you need to return the device to the factory with the original wrapper. Transportation without the original wrapper may result in damage on the device and the company shall not take any responsibilities.
- Do not drop the product or subject it to physical shock. Keep the device away from magnetic interference.

Power Supply

- The input voltage should meet the limited energy circuit (5 VDC, 2 A) according to the IEC61010-1 standard. Please refer to technical specifications for detailed information.
- Make sure the plug is properly connected to the power socket.
- DO NOT connect multiple devices to one power adapter, to avoid overheating or fire hazards caused by overload.
- For the device without a supplied power adapter, use the power adapter provided by a qualified manufacturer. Refer to the product specification for detailed power requirements.

Battery

- Improper use or replacement of the battery may result in explosion hazard. Replace with the same or equivalent type only. The battery type is HM-AHB02-3754. Dispose of used batteries in conformance with the instructions provided by the battery manufacturer.
- Do not charge other battery types with the supplied charger. Confirm there is no flammable material within 2 m of the charger during charging.
- For long-term storage of the battery, make sure it is fully charged every half year to ensure the battery quality. Otherwise, damage may occur.
- DO NOT place the battery near heating or fire source. Avoid direct sunlight.
- DO NOT swallow the battery to avoid chemical burns.
- DO NOT place the battery in the reach of children.
- CAUTION: Risk of explosion if the battery is replaced by an incorrect type.
- Do not dispose of the battery into fire or a hot oven, or mechanically crush or cut the battery, which may result in an explosion.
- Do not subject the battery to extremely low air pressure, which may result in an explosion or the leakage of flammable liquid or gas.
- When the device is powered off and the RTC battery is full, the time settings can be kept for 90 days.
- In the first use, power on the device and charge the RTC battery with the lithium battery for more than 10 hours.
- The battery voltage is 3.7 V, and the battery capacity is 5400 mAh.

Maintenance

- If the product does not work properly, please contact your dealer or the nearest service center. We shall not assume any responsibility for problems caused by unauthorized repair or maintenance.
- Wipe the device gently with a clean cloth and a small quantity of ethanol, if necessary.
- If the device is used in a manner not specified by the manufacturer, the protection provided by the device may be impaired.
- Please notice that the current limit of USB 3.0 PowerShare port may vary with the PC brand, which is likely to result in incompatibility issue. Therefore, it's advised to use regular USB 3.0 or USB 2.0 port if the USB device fails to be recognized by PC via USB 3.0 PowerShare port.
- Your camera will periodically perform a self-calibration to optimize image quality and measurement accuracy. In this process the image will pause briefly and you will hear a "click" as a shutter moves in front of the detector. The self-calibration will be more frequent during the startup or in very cold or hot environments. This is a normal part of operation to ensure optimum performance for your camera.

Using Environment

- DO NOT expose the device to extremely hot, cold, dusty, corrosive, saline-alkali, or damp environments. Make sure the running environment meets the requirement of the device. The operating temperature shall be -20 °C to 60 °C (-4 °F to 140 °F), and the operating humidity shall be less than 95%.
- Place the device in a dry and well-ventilated environment.
- DO NOT expose the device to high electromagnetic radiation or dusty environments.
- DO NOT aim the lens at the sun or any other bright light.
- When any laser equipment is in use, make sure that the device lens is not exposed to the laser beam, or it may burn out.
- The device is suitable for indoor conditions.
- The pollution degree is 2.
- The protection level is IP67.

Calibration Service

We recommend you send the device back for calibration once a year, and please contact the local dealer for the information on maintenance points.

For more detailed calibration services, please visit <https://www.hikmicrotech.com/en/support/calibration-service.html>.

Technical Support

<https://www.hikmicrotech.com/en/contact-us.html> will help you as a HIKMICRO customer to get the most out of your HIKMICRO products. The portal gives you access to our support team, software and documentation, service contacts, etc.

Emergency

If smoke, odor, or noise arises from the device, immediately turn off the power, unplug the power cable, and contact the service center.

Manufacture Address

Room 313, Unit B, Building 2, 399 Danfeng Road, Xixing Subdistrict, Binjiang District, Hangzhou, Zhejiang 310052, China

Hangzhou Microimage Software Co., Ltd.

COMPLIANCE NOTICE

The thermal series products might be subject to export controls in various countries or regions, including without limitation, the United States, European Union, United Kingdom and/or other member countries of the Wassenaar Arrangement. Please consult your professional legal or compliance expert or local government authorities for any necessary export license requirements if you intend to transfer, export, re-export the thermal series products between different countries.

TABLE OF CONTENTS

1	Overview	1
1.1	Device Description	1
1.2	Main Function	1
1.3	Appearance	2
1.3.1	Component Description	2
1.3.2	Button Operation	4
2	Quick Use Process	7
3	Basic Operations	8
3.1	Charge the Device	8
3.1.1	Charge Battery via Charging Base	8
3.1.2	Charge Device via USB Cable	9
3.2	Power On/Off	10
3.3	Commonly Used Functions	10
3.3.1	Read Screen Information	10
3.3.2	Switch Image Mode	13
3.3.3	Zooming in Interested Objects	15
3.3.4	Capture Snapshots and Record Videos	15
3.3.5	View Files in Albums	15
3.3.6	Export Files to PC	16
3.4	Connect to Client Software	16
3.4.1	Mobile Client HIKMICRO Viewer	16
3.4.2	UVC Cast Screen Tool	17
3.5	Mount Neck Strap and Lanyards	18
3.5.1	Mount Neck Strap	18
3.5.2	Install Lanyards	18
4	More Settings	20
4.1	Temperature Measurement Settings	20
4.1.1	Adjust Thermal Readout	20
4.1.2	Change Temperature Unit	21
4.1.3	Display Real-time Hot and Cold Spots	21
4.1.4	Object Details Enhancement (ODE)	21
4.2	Album and Files Management	22
4.2.1	Naming Rule of Album Folder and File	22
4.2.2	Delete a File	22
4.3	Direction Display	23
4.3.1	Calibrate Compass	23

Firefighting Thermal Camera • User Manual

4.3.2	Magnetic Declination Correction	24
4.4	Date and Time Settings	24
4.4.1	Set Date	24
4.4.2	Set Time	25
5	Maintenance.....	25
5.1	Upgrade System	25
5.2	Restore Device	26
5.3	About Calibration	26

1 Overview

1.1 Device Description

The professional firefighting thermal camera is a product designed for firefighting and life rescue. It is easy to operate even with gloves. It supports multiple display modes for different on-site purposes, for example firefighting, hidden fire point searching, life rescue, building analysis, etc. These modes can help fire and rescue personnel detect and understand the temperature status of the scene and detect life signs more efficiently.

1.2 Main Function

Multiple Image Display Modes

The camera supports multiple image display modes suitable for different scenes and targets. It helps quickly distinguish targets from rest of the objects. Some modes also offer image temperature for reference.

Target Zooming

The camera supports 3 zoom ratios for users to check on details from a distance.

On-site Image Capture

The camera supports image capture and storage.

Hotspot

It provides hotspot function for connecting to mobile device for data transmission.

Client Software Connection

- Mobile Phone: Use HIKMICRO Viewer to view live image, capture snapshots, and record videos on your phone. You can also, analyze pictures offline, generate and share a report via the app.
- PC: Use HIKMICRO Analyzer to analyze pictures offline professionally and generate a custom format report on your PC. Download the client software from <https://www.hikmicrotech.com/en/industrial-products/hikmicro-analyzer-software.html>

1.3 Appearance

1.3.1 Component Description

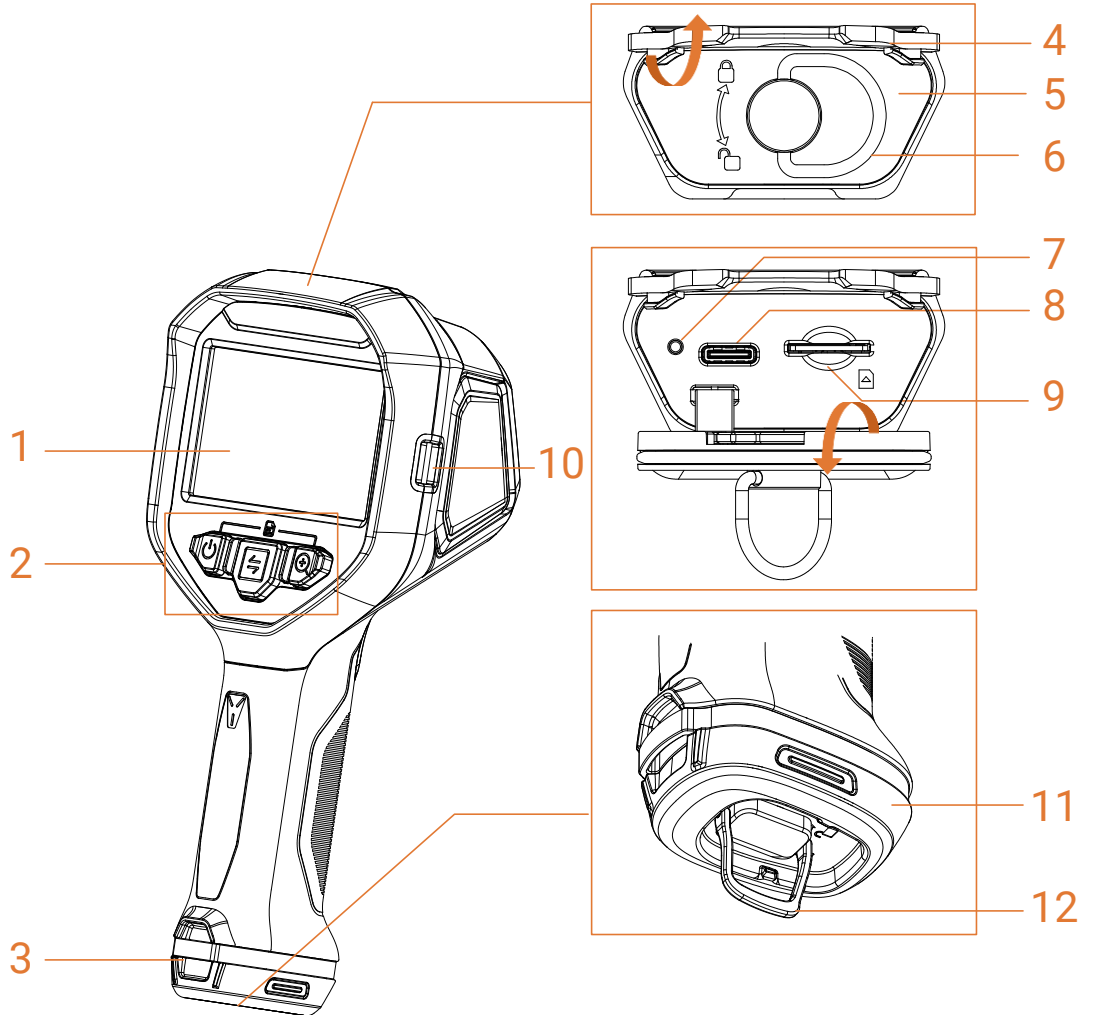

Figure 1-1 Appearance (Front View)

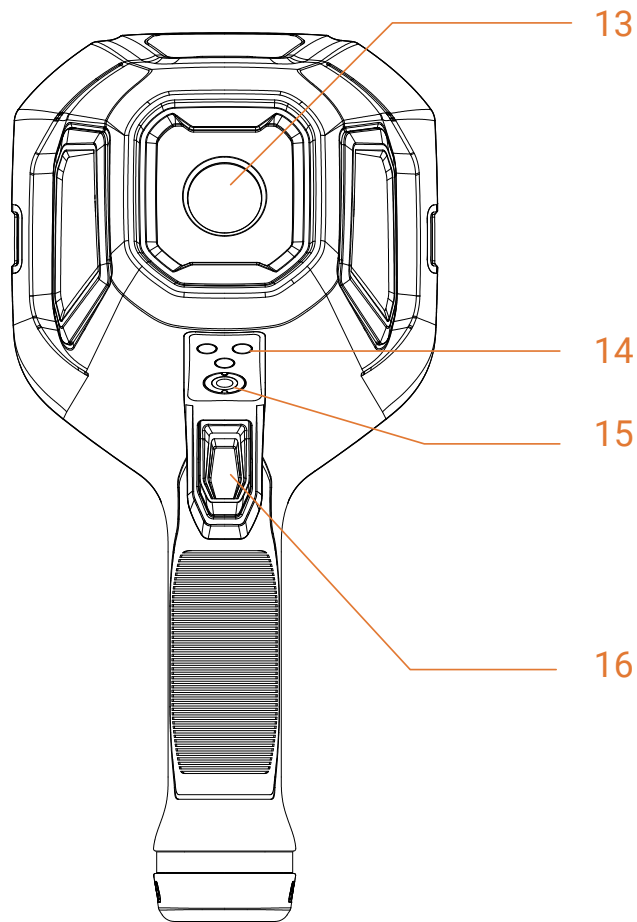

Figure 1-2 Appearance (Rear View)

Table 1-1 Appearance Description

No.	Part Name	Description
1	Screen	Display view and operation menu.
2	Buttons	Operate the camera. See 1.3.2 Button Operation for operation guide.
3	Lanyard Mounting Point	Mount lanyard for easy carrying. See 3.5.2 Install Lanyards for lanyard mounting guide.
4	Rubber Cover	Cover interfaces.
5	Interface Cover	Protect interfaces.
6	Ring-Pull Handle for Interface	Turn the ring-pull handle to unlock and lock the cover. After unlocking, pull to open the cover.

7	Charging Indicator	<ul style="list-style-type: none"> • Solid Red: The battery is charging normally. • Solid Green: The battery is fully charged. • Red and Green Flash: Battery charging exception.
8	USB Type-C Interface	Charge the device or export files with USB type-A to type-C cable.
9	SIM Card Slot	Reserved.
10	Neck Strap Mounting Point	Mount the neck strap. See 3.5.1 Mount Neck Strap for neck strap mounting guide.
11	Battery	Supply power to the device.
12	Ring-Pull Handle for Battery	Turn the ring-pull handle to unlock and lock the battery. Pull the battery out when the battery is unlocked.
13	Thermal Imaging Lens	View the thermal image.
14	Charging Contacts	Reserved.
15	Tripod Mount	Mount the tripod.
16	Trigger	<ul style="list-style-type: none"> • Live view interface: Live view interface: Pull the trigger to capture snapshot, or hold the trigger to start recording a video and pull again to stop recording. • Menu interface: Browse options from bottom to top or reduce value when setting a parameter.

1.3.2 Button Operation

Button and trigger function are different in live view interface or in menu interface.

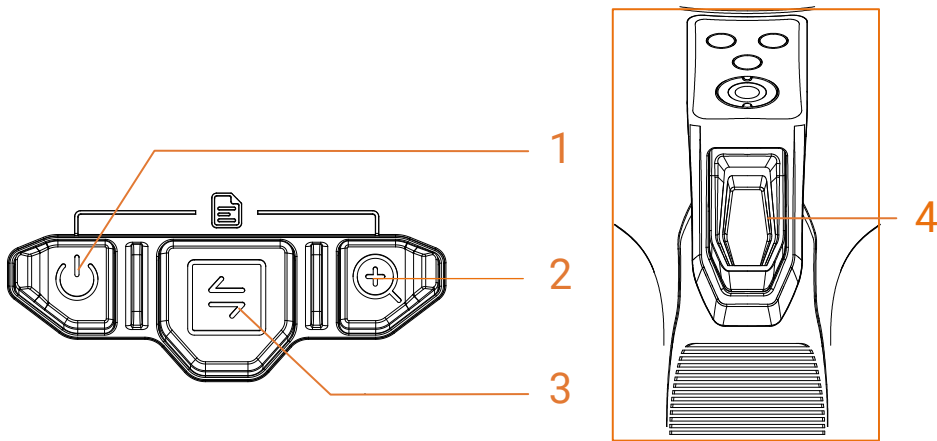

Figure 1-3 Buttons and Trigger

Live View Interface

Button and trigger function in live view is shown in the following table.









Table 1-2 Buttons and Trigger Operation in Live View

Button	Description
1	Power button. Hold to power on or off the camera.
2	Zoom-in button. Press to switch among the 3 zoom-in ratios.
3	Mode button. Press to switch among image modes. See 3.3.2 Switch Image Mode for the introduction of the image modes.
4	Trigger. Pull the trigger to capture snapshot, or hold the trigger to start recording a video and pull again to stop recording.
1+2	Press the power button and zoom-in button together to enter camera menu.

Menu Interface

After entering the menu interface, you can operate 3 buttons (power button, zoom-in button, and mode button) according to the function icons on the lower side of the screen. The icons and functions displayed in the screen are shown in the table below.



Table 1-3 Icons in Menu Interface

Screen Display Icon	Description	Screen Display Icon	Description
	Go back to the live view interface.		Back to previous menu.
	Enter album.		Delete.
	Enter system menu.		Cancel.
	Next.		Confirm.
	Enter/Confirm.		

In addition, when browsing menu or adjusting parameters, **pull trigger to select item from bottom to top or reduce value.**

2 Quick Use Process

You can follow the steps to quickly use the camera.

1. For the first time using, please fully charge the camera or install a fully-charged battery. See **3.1 Charge the Device** for charging guide.
2. Hold  to start the camera.
3. Hold and aim the camera to target for temperature measurement or observation.
4. Press  to switch image mode. See **3.3.2 Switch Image Mode** for the introduction of the image modes.
5. Pull the trigger to capture snapshots, or hold the trigger to start recording and pull again to stop recording.
6. View the saved files in the local albums. See **3.3.5 View Files in Albums** for operation guide.
7. Export the snapshots for analysis and report generation, and the videos to view. See **3.3.6 Export Files to PC** for the exporting guide.

3 Basic Operations

3.1 Charge the Device

For the first time using or when the battery is insufficient, please charge the thermal camera or replace a battery.

You can see the battery status by checking the battery icon in the status bar.



Note

Please charge the device with the cable and charging base provided by the manufacturer.

3.1.1 Charge Battery via Charging Base

Use charging base provided by the manufacturer to charge the batteries.

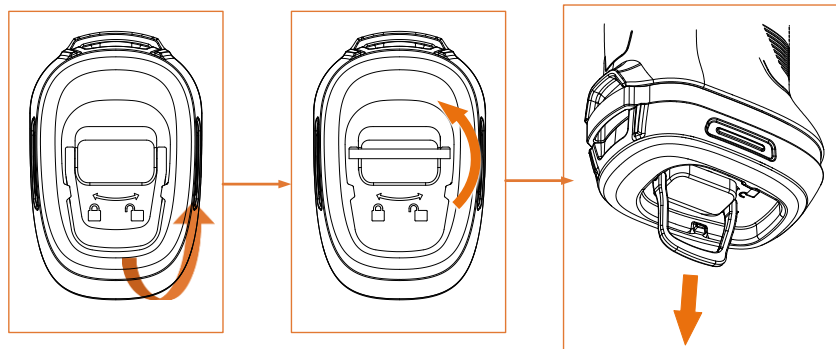

Figure 3-1 Removing Battery

1. Pull out the ring on battery and turn it 90° to unlock the battery.
2. Pull the battery out.
3. Insert the battery to the charging base.
4. Checking the indicator for charging status.



Note

- Solid Red: Charging normally.
 - Solid Green: Fully charged.
-

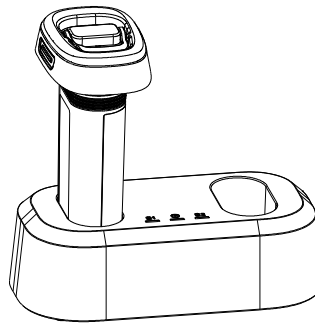

Figure 3-2 Charge Battery

5. When the battery is fully charged, remove it from the base.
6. Align the battery with battery compartment, push it to the end and turn the ring 90° to lock the battery.

3.1.2 Charge Device via USB Cable

The camera can also be charged via the USB Type-C cable.

Before You Start

Battery should be installed if you charge the device with a USB cable.

1. Open the rubber cover and interface cover on top of the camera to show the USB Type-C interface (②).

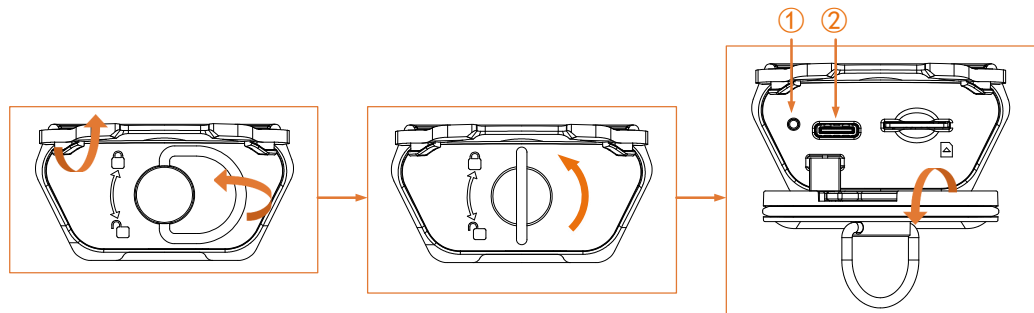

Figure 3-3 Show Type-C Interface

2. Connect the camera to a USB Charger (should be prepared by user) or your PC with the provided USB type-C to type-A cable.
3. Checking the charging status via the indicator (①) near the type-C interface.





Note

- Solid Red: Charging normally.
 - Solid Green: Fully charged.
 - Flashing Red and Green: Charging exception.
-

4. When charging completes, disconnect the cable.
5. Lock the interface cover and shut the rubber cover.

3.2 Power On/Off

Hold  to power on the device. The camera enters live view interface after starting-up.

Hold  to power off the camera when it is not used.

3.3 Commonly Used Functions

3.3.1 Read Screen Information

The camera screen has live view interface and menu interface serving different purposes.

Live View Interface

The live view interface is for user to view thermal image and target temperature. Understanding the icons and figures in advance is helpful for first-time using.

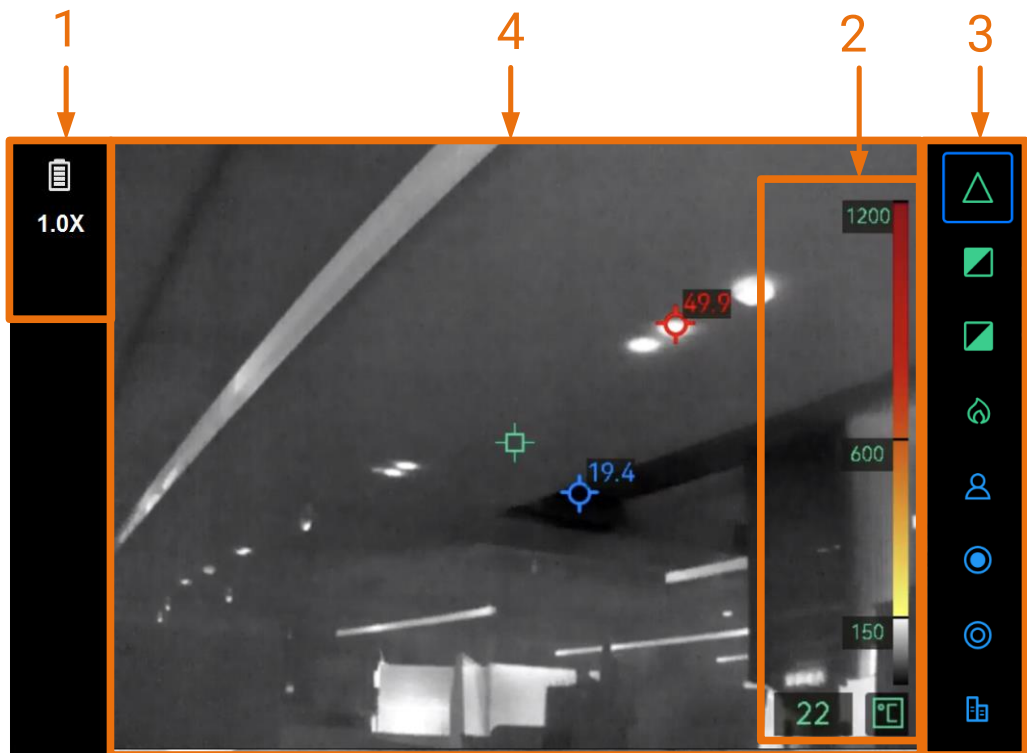















Figure 3-4 Live View Interface

No.	Description
1	<p>Status Bar. Icons in this bar show device hardware status, including:</p> <ul style="list-style-type: none"> • Battery and charging status. For example,  means fully charged. • Hotspot is enabled, . For hotspot connection, see 3.4 Connect to Client Software for instructions. • Zooming ratio (1.0X, 2.0X, 4.0X). For the zooming operation, see 3.3.3 Zooming in Interested Objects. • USB cast screen is enabled, . For more screen casting instructions, refer to 3.4.2 UVC Cast Screen Tool. • Object Details Enhancement (ODE) is enabled, . For more information about ODE, refer to 4.1.4 Object Details Enhancement (ODE). • Compass is on, . The number stands for the calibration level. Numbers smaller than 3 mean that the compass is not properly calibrated and the direction displayed might not be correct. For correcting the magnetic declination, refer to 4.3.2 Magnetic

<i>Declination Correction.</i>	
2	Thermal readout area. There are 3 types of thermal readout style available. Refer to 4.1.1 Adjust Thermal Readout for details of the 3 display style and settings.
3	Image Mode Bar. Available image modes are listed in this bar. The mode with blue box is the mode currently in use. Mode description and switching operation are explained in 3.3.2 Switch Image Mode .
4.	Live image area.  marks the center point of the live scene.  marks the highest temperature point and  the lowest temperature point in the scene. You can turn on/off of the highest and lowest temperature point display. Refer to 4.1.3 Display Real-time Hot and Cold Spots for instructions.

Menu Interface

In live view interface, press  and  together to enter camera menu to check system information of device. Then, press  to select  and enter local albums, or press  to select  and enter system setting menu.

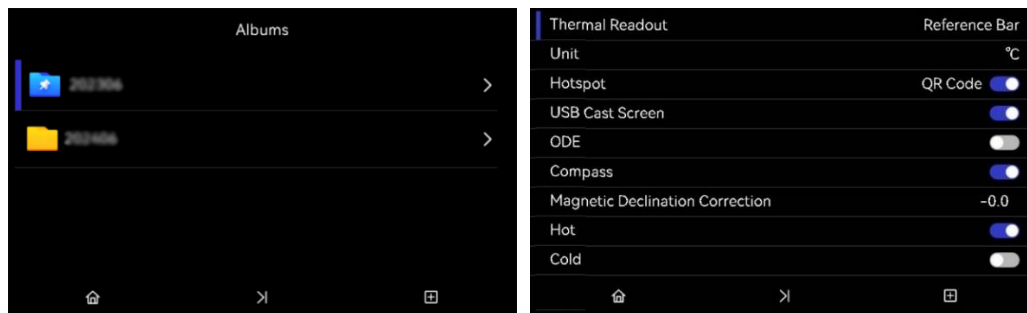

Figure 3-5 Albums and System Settings

- For viewing snapshots and exporting files, refer to **3.3.5 View Files in Albums** and **3.3.6 Export Files to PC**.
- For local album management, refer to **4.2 Album and Files Management**.
- For system settings, refer to **4 More Settings**.

3.3.2 Switch Image Mode















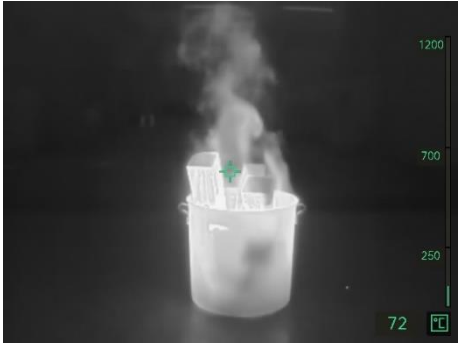

In live view interface, press  to switch image modes. The camera supports multiple modes suitable for different scenes and objects.

Table 3-1 Image Modes Description

Mode	Mode Description	Example Snapshot
	<p>Basic mode (default). It is applicable to firefighting, and life searching and rescue. The real-time temperature is marked with the corresponding colors in the color-temperature scale.</p>	
	<p>White hot mode. It is applicable to firefighting and life searching and rescue scenarios. Black and white image. Temperature of white areas is higher.</p>	
	<p>Black hot mode. It is applicable to firefighting and life searching and rescue scenarios. Black and white image. Temperature of darker areas is higher.</p>	

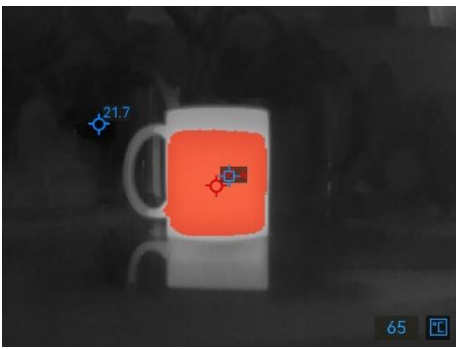
	<p>Fire detection mode.</p> <p>It is applicable to scenes with many open fires and high background temperature.</p> <p>The display effect is similar to the basic mode. Only that the start temperature of red and yellow marking is higher.</p>	
	<p>Rescue mode.</p> <p>The mode is suitable for searching and rescuing people in the field, building, or traffic accident scene.</p> <p>The display effect is similar to the basic mode. Only that the start temperature for red and yellow marking is lower.</p>	
	<p>Hot area mode.</p> <p>This mode detects high temperature targets of the scene and mark them in red.</p> <p>This mode is applicable to search remaining fire during overhaul after fire is basically out, people in water or field, etc.</p>	
	<p>Cold area mode.</p> <p>This mode detects low temperature targets of the scene and mark them in blue.</p> <p>This mode is used to search cold spots in fire scenes, such as gas streams that may provide oxygen or fuel for burning.</p>	

	<p>Building mode.</p> <p>Applicable to analysis and detection of building-related exceptions. Thermal images can provide information about structure, machinery, pipe, and electrical system.</p>	
---	---	--

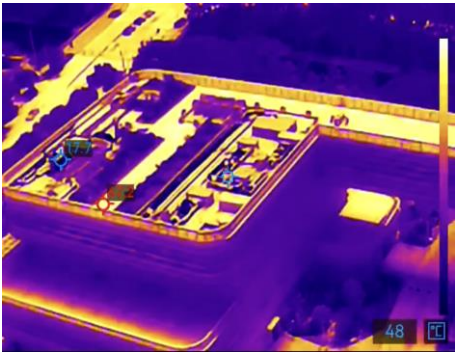
3.3.3 Zooming in Interested Objects

In live view interface, aim the camera to a target and press  to switch zoom ratio. The camera supports 3 zoom ratios, 1.0X, 2.0, and 4.0X. You can check current zoom ratio from the status bar.

3.3.4 Capture Snapshots and Record Videos

In live view interface, aim the camera to a target, and pull trigger to capture a snapshot, or hold the trigger to start recording a video and pull again to stop. Snapshots and videos are saved in local albums.

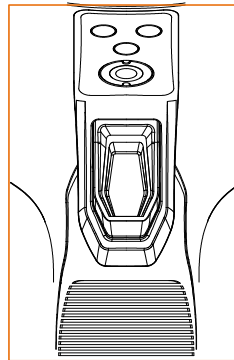











Figure 3-6 Trigger

3.3.5 View Files in Albums

1. In live view interface, press  and  to enter menu interface.
2. Select  to enter albums.
3. Press  to select an album folder and press  to enter.
4. Press  to browse files and press  to view the details.

5. Press  or pull trigger to view the next or previous file.
 6. Press  to go back to upper-level menu.
-



Note

Playing videos in the local albums is not supported. Refer to **3.3.6 Export Files to PC** to export videos to PC to view.

3.3.6 Export Files to PC

Connect the camera and PC via the provided USB cable to export snapshots and videos, and view them on PC.

Before You Start

Before exporting files, turn off USB Cast Screen function.

1. Expose the type-C USB interface on top of the camera. See Figure 3-3 for operation steps.
 2. Connect the camera to PC with a type-A to type-C cable. The camera storage appears in the PC as a removable disk.
 3. Open the detected disk and enter the album folder.
 4. Copy files and save them in your PC.
 5. Disconnect the USB cable and lock the interface cover.
-



Note

You can import the snapshots to HIKMICRO Analyzer for further data analysis. See the User Manual of HIKMICRO Analyzer (click on  in the upper right corner of the client interface to download the User Manual) for the operation guide.











3.4 Connect to Client Software

3.4.1 Mobile Client HIKMICRO Viewer

HIKMICRO Viewer is a mobile client for users to view live image, capture snapshots and adjust device settings, etc.

Download and install the latest HIKMICRO Viewer to your mobile device.

The camera supports hotspot for wireless connection.

1. Enable hotspot of camera.
 - 1) In live view interface, press  and  together to enter menu.
 - 2) Select  to enter system setting menu.
 - 3) Press  to select Hotspot, and press  to enter hotspot configuration.
 - 4) Press  to move the box to  and press  to enable hotspot.
 - 5) Press  to move the box to QR Code, and press  to show the code.
2. Connect the camera to HIKMICRO Viewer.
 - 1) On mobile device, enter HIKMICRO Viewer and tap "+" in the upper right corner.
 - 2) Select "Scan" and aim the camera of your mobile device to the QR Code. Then the client starts to add your thermal camera.
 - 3) You can see camera live image via the APP after adding process finishes.



Note







For more using guide of the client, please check its embedded user manual from **Settings > Help**.

3.4.2 UVC Cast Screen Tool

The device supports casting screen to PC by UVC protocol-based client software or player. Connect the device to your PC via a type-C cable, and cast the real-time live view of the device to your PC.

Before You Start

Install a player supporting the UVC protocol to your PC.

1. Enable USB Cast Screen on your camera.
 - 1) In live view interface, press  and  together to enter menu.
 - 2) Select  to enter system setting menu.
 - 3) Press  to select USB Cast Screen, and press  to enable the function.
 - 4) Press  to return to live view interface.
2. Open the UVC player/client on your PC.

3. Connect the camera to the PC with a USB cable. To expose the USB interface of the camera, see Figure 3-3 for instructions.
4. The live image of the camera then displays on your PC.

3.5 Mount Neck Strap and Lanyards

The camera is equipped with a neck strap and lanyards for convenient carrying and preventing from accidental falling.

3.5.1 Mount Neck Strap

Install neck strap in the way as shown in the figure below.

1. Fold one end of the neck strap through the neck strap point (③) on one side of the camera, and thread it back through the slide buckle (①) and the fastening collar (②).
2. Repeat step 1 to install the other end of the strap.

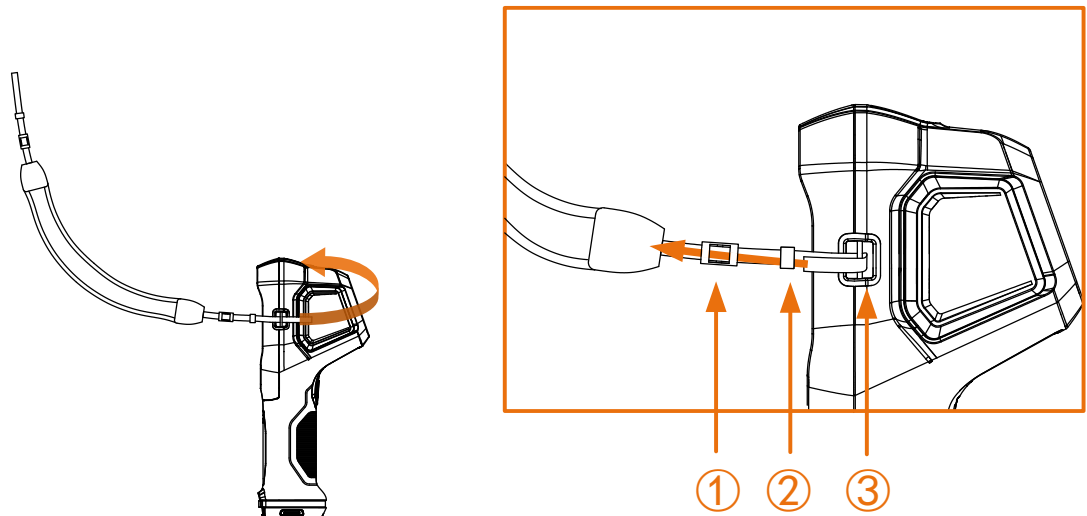

Figure 3-7 Install Neck Strap

3.5.2 Install Lanyards

Install the lanyard (②) to the lanyard hole (①) first, then install the retractable lanyard (③) to the first lanyard.

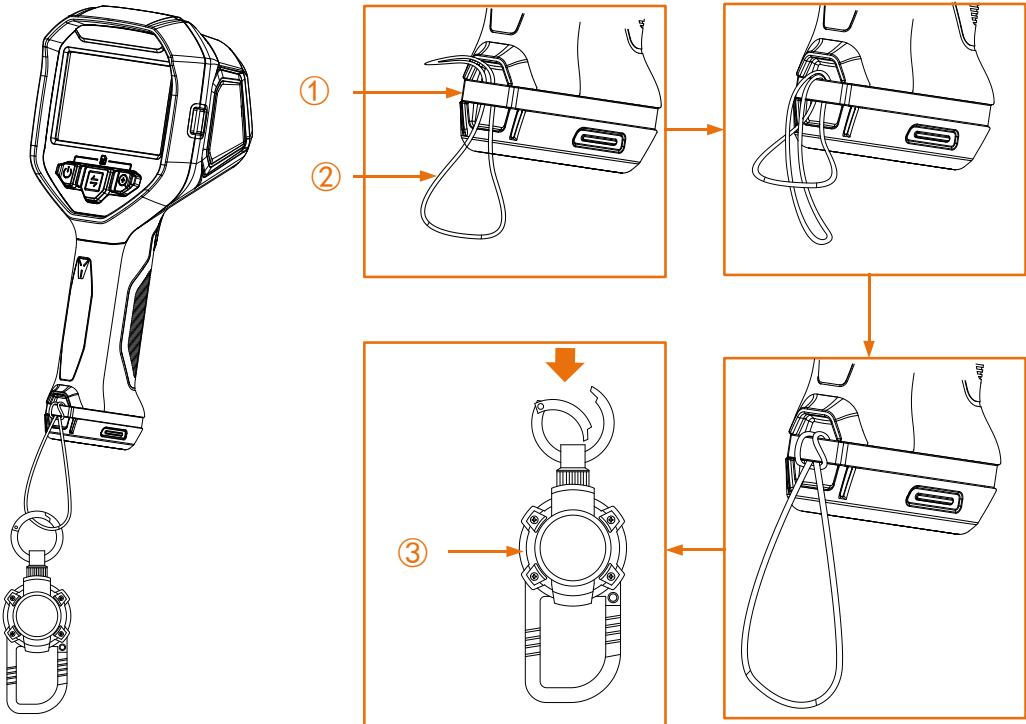





Figure 3-8 Install Lanyards

4 More Settings

4.1 Temperature Measurement Settings

4.1.1 Adjust Thermal Readout

Thermal readout refers to the referential palette color bar, temperature scale and image center temperature that help user to know temperature condition of target scene. There are 3 types of readout available.

1. In live view interface, press  and  together to enter menu.
2. Select  to enter system menu.
3. Select Thermal Readout, and press  to switch readout style.
 - Temperature Bar ①: Show palette color bar and temperature scale (④), center point temperature bar (⑤), and center point temperature value (⑥).
 - Reference Bar ③: Show palette color bar and temperature scale and center point temperature value.
 - Digital Readout Only ②: Show center point temperature value only.

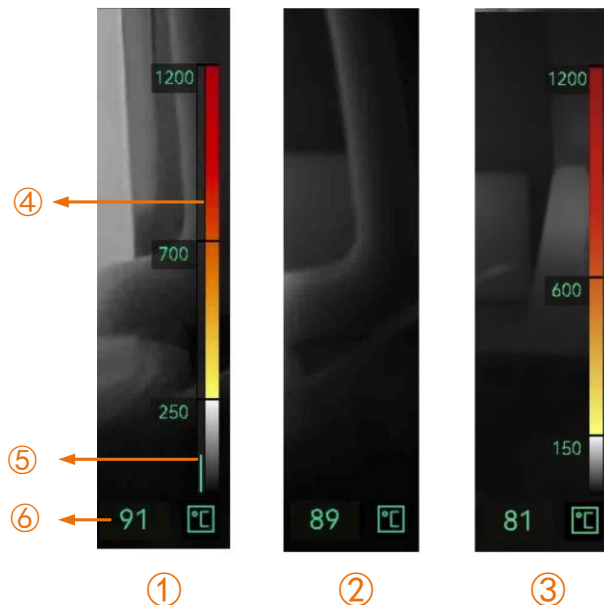



Figure 4-1 Thermal Readout

4. Press  to return to the live view interface.









Note



Thermal readout of different image modes are different. The figure above is an example for reference.







4.1.2 Change Temperature Unit

The camera supports 3 temperature units: degree Celsius (°C), degree Fahrenheit °F (°F), and Kelvin (K). The temperature unit is displayed in the lower right corner of the live view interface.

1. In live view interface, press  and  together to enter menu.
2. Select  to enter system setting menu.
3. Press  to select Unit, and press  to switch among the three units.
4. Press  to return to the live view interface.

4.1.3 Display Real-time Hot and Cold Spots

The camera supports displaying the highest (hot) and lowest temperature (cold) spot in the live view. After enabling the function, the hot spot is marked with  and the cold spot is marked with . Real-time temperatures are displayed next to the marks.

1. In live view interface, press  and  together to enter menu.
2. Select  to enter system setting menu.
3. Press  to select Hot or Cold, and press  to enable the spot.
4. Press  to return to the live view interface.

4.1.4 Object Details Enhancement (ODE)

Object Details Enhancement (ODE) is used to enhance outline of certain targets. With this function enabled, target outline will be clearer, but noise of the image will be increased accordingly.

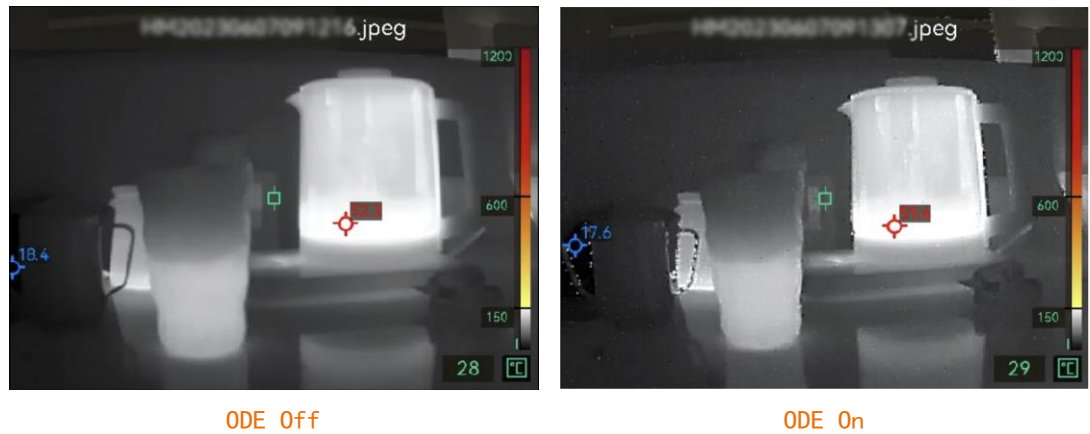









Figure 4-2 Image Example of ODE On and Off

1. In live view interface, press  and  together to enter device menu.
2. Select  to enter the system menu.
3. Press  to select ODE, and press  to enable the function.
4. Press  to return to live view interface. You can see  in the status bar on left of the screen.

4.2 Album and Files Management











4.2.1 Naming Rule of Album Folder and File

The naming of album folders and files depends on the system date and time. Please set the system date and time correctly before taking snapshots or videos, otherwise you may find it difficult to locate a snapshot or video.

- File name of a file is the saving date and time.
- Files are saved in monthly named album folders according to the saving time. The folder name is 6-digit number of the year and month. For example, “202306” means June, 2023.
- A new snapshot or video is automatically saved in the auto-generated album .

4.2.2 Delete a File

Snapshots and videos saved in local albums can be deleted. Before deleting, make sure that important data is exported for backup. For instructions of exporting, refer to **3.3.6 Export Files to PC**.

1. In live view interface, press  and  together to enter device menu.
2. Select  to enter device albums.
3. Press  to select an album, and press  to enter the folder.
4. Press  to select a file, and press  to view the details.
5. Press  to delete.
6. Press  to confirm or  to cancel the deleting.
7. When finished, press  to return to the previous menu.

4.3 Direction Display





Equipped with a compass, the device is able to display its direction on the live image and in the captured images. You can follow the pop-up instructions to calibrate the compass. See **4.3.1 Calibrate Compass** for more information.

After successful calibration, you can see the direction displayed at lower left corner of the screen. It is recommended to read the direction when you lay the device horizontally.

To increase the direction accuracy, you can set the magnetic declination correction. See **4.3.2 Magnetic Declination Correction** for instructions.

4.3.1 Calibrate Compass

Compass calibration is a must for correct direction display. You need to calibrate the compass when you enable the function for the first time.

1. In live view interface, press  and  together to enter device menu.
2. Select  to enter the system menu.
3. Press  to select Compass, and press  to enable.
4. Follow the screen instructions to move and rotate the camera.

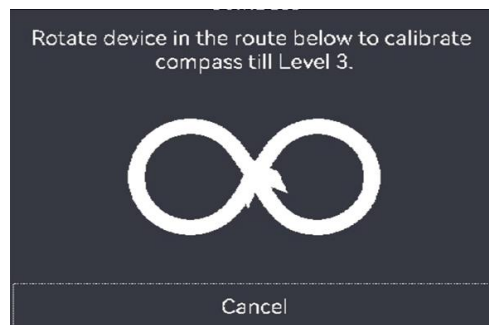



Note

During calibration, keep moving and rotating the device to make sure that the camera faces every possible directions







5. Stop moving the camera when calibration success message pops up.

Result

The status bar in the live view interface shows  after successful calibration. If the number in this icon is smaller than 3, it means that the compass is not properly calibrated and the direction displayed might not be correct.

4.3.2 Magnetic Declination Correction

Magnetic declination is the angle variation between magnetic north and true north. Adding the magnetic declination to the compass increase the accuracy of direction reading.

1. In live view interface, press  and  together to enter menu.
2. Select  to enter the system menu.
3. Press  to select Magnetic Declination Correction, and press .
4. Pull the trigger or press  to configure the magnetic declination.
5. Press  to save and exit.

4.4 Date and Time Settings

The system date and time affect the name of snapshots and local album folders.

4.4.1 Set Date







1. In live view interface, press  and  together to enter device menu.
2. Select  to enter the system menu.
3. Press  to select Date, and press  to adjust the system date.
4. Press  to switch from setting year, month and date. The parameter in adjustment is displayed with a blue box.



Figure 4-3 Date Settings

5. Press to increase the value, and **pull trigger to reduce the value.**
6. Press to exit.

4.4.2 Set Time

1. In live view interface, press and together to enter device menu.
2. Select to enter the system menu.
3. Press to select Time, and press to adjust the system time.

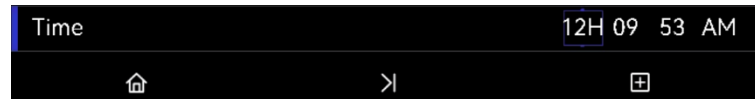

Figure 4-4 Time Settings



4. Press to switch from setting time format, hour and minute. The parameter in adjustment is displayed with a blue box.
5. Press to increase the value, and **pull trigger to reduce the value.**
6. Press to exit.

5 Maintenance

5.1 Upgrade System







Before You Start

- Please download the upgrade file from the official website <http://www.hikmicrotech.com> or contact the custom service and technical support to get the upgrade file first.
 - Make sure that the device battery is fully charged.
1. Connect the device to your PC with a type-C to type A cable and open the detected disk.
 2. Copy the upgrade file and paste it to the root directory of the device.
 3. Disconnect the device from your PC.

4. Reboot the device and then it will upgrade automatically. The upgrading process will be displayed in the main interface.
5. After upgrading, you can check the version information by pressing  and  together in live view interface.

5.2 Restore Device

Restore the device to the factory settings. Use this function with caution.

1. In live view interface, press  and  together to enter device menu.
2. Select  to enter the system menu.
3. Press  to select Restore Device, and press .
4. Press  to start restoring and or  to cancel.

5.3 About Calibration

We recommend you send the device back for calibration once a year, and please contact the local dealer for the information on maintenance points. For more detailed calibration services, please refer to <https://www.hikmicrotech.com/en/support/calibration-service/>.

Appendix A Frequently Asked Questions (FAQ)

Scan the following QR code to get device common FAQ.





HIKMICRO

See the World in a New Way

Facebook: HIKMICRO Thermography
Instagram: hikmicro_thermography
E-mail: support@hikmicrotech.com
Website: www.hikmicrotech.com

LinkedIn: HIKMICRO
YouTube: HIKMICRO Thermography

UD35915B